

Reversible Logic Synthesis

By

Dmitri Aleksandrovich Maslov

M.Sc. in Mathematics, Lomonosov's Moscow State University, 1998
Master's in Computer Science, University of New Brunswick, 2001

A Thesis Submitted in Partial Fulfillment of

The Requirements for the Degree of

Doctor of Philosophy

In the Graduate Academic Unit of Computer Science

Supervisor(s): Gerhard W. Dueck, Ph.D., Computer Science

Examining board: Julian Meng, Ph.D., Electrical & Computer Engineering
 Patricia A. Evans, Ph.D., Computer Science
 Viqar Husain, Ph.D., Mathematics and Statistics

External Examiner: Dr. Marek Perkowski, Dept. of Electrical Engineering
 & Computer Science, Korea Advanced Institute of
 Science & Technology (KAIST)

This thesis is accepted.

 Dean of Graduate Studies

THE UNIVERSITY OF NEW BRUNSWICK

September, 2003

(c) Dmitri Aleksandrovich Maslov, 2003



Library and
Archives Canada

Bibliothèque et
Archives Canada

Published Heritage
Branch

Direction du
Patrimoine de l'édition

395 Wellington Street
Ottawa ON K1A 0N4
Canada

395, rue Wellington
Ottawa ON K1A 0N4
Canada

Your file *Votre référence*

ISBN: 0-612-98874-0

Our file *Notre référence*

ISBN: 0-612-98874-0

NOTICE:

The author has granted a non-exclusive license allowing Library and Archives Canada to reproduce, publish, archive, preserve, conserve, communicate to the public by telecommunication or on the Internet, loan, distribute and sell theses worldwide, for commercial or non-commercial purposes, in microform, paper, electronic and/or any other formats.

The author retains copyright ownership and moral rights in this thesis. Neither the thesis nor substantial extracts from it may be printed or otherwise reproduced without the author's permission.

AVIS:

L'auteur a accordé une licence non exclusive permettant à la Bibliothèque et Archives Canada de reproduire, publier, archiver, sauvegarder, conserver, transmettre au public par télécommunication ou par l'Internet, prêter, distribuer et vendre des thèses partout dans le monde, à des fins commerciales ou autres, sur support microforme, papier, électronique et/ou autres formats.

L'auteur conserve la propriété du droit d'auteur et des droits moraux qui protègent cette thèse. Ni la thèse ni des extraits substantiels de celle-ci ne doivent être imprimés ou autrement reproduits sans son autorisation.

In compliance with the Canadian Privacy Act some supporting forms may have been removed from this thesis.

Conformément à la loi canadienne sur la protection de la vie privée, quelques formulaires secondaires ont été enlevés de cette thèse.

While these forms may be included in the document page count, their removal does not represent any loss of content from the thesis.

Bien que ces formulaires aient inclus dans la pagination, il n'y aura aucun contenu manquant.

Canada

Abstract

Reversible logic is an emerging research area. Interest in reversible logic is sparked by its necessity in quantum technologies. Reversible implementations are also found in optical technology, nanotechnology, thermodynamics and adiabatic CMOS. Power dissipation in modern technologies is an important issue, and overheating is a serious concern for both manufacturer (impossibility of introducing new, smaller scale technologies, limited temperature range for operating the product) and customer (power supply, which is especially important for mobile systems). One of the main benefits that reversible logic brings is theoretically zero power dissipation in the sense that, independently of underlying technology, irreversibility means heat generation.

Most of the listed technologies are either emerging or not fully investigated. As a result, only a small number of Boolean functions can be computed using hardware based on reversible technology. Part of this problem comes from the incompleteness of the technological results, the other part arises from absence of good circuit synthesis procedures. Synthesis of multiple-output functions has to be done in terms of reversible objects. This usually results in addition of garbage bits (bits needed for reversibility, but not required for the output part of a circuit), which in contrast to the non-reversible case is technologically difficult and expensive. The situation is rather pessimistic when it is observed that proposed synthesis procedures use excessive garbage.

The amount of garbage is a very important criterion for a good synthesis procedure, since in most technologies the addition of only one bit of garbage is expensive or even impossible to implement. Based on this information, a crucial way to help reversible logic to evolve and become usable is to design a synthesis method which uses the theoretically minimal number of garbage bits. This will help the emerging technologies to use the results of reversible synthesis even in the early stage of their development. Minimal garbage realization may require a larger number of gates in the circuit, but it is better to have a large but working circuit than a small one that is not ready for the technology.

In this thesis several synthesis methods that use minimal garbage are considered: RCMG

Abstract

model (defined as a part of this thesis), Toffoli synthesis, Fredkin/Toffoli synthesis. Dynamic programming algorithms are synthesized separately with near minimal garbage. Some of the methods use minimal garbage and produce small circuits (Toffoli and Fredkin/Toffoli synthesis) but work with reversible specifications, some handle "don't cares" (RCMG), some even allow a trade-off between the garbage amount and the number of gates in the resulting circuit. When a technology is chosen and the relationship between costs of one bit of garbage and a single gate is specified, one or the other method may be better. In the presented thesis the main goal is to design synthesis methods that will be suitable for different cost distributions.

Acknowledgments

I would like to thank Dr. Marek Perkowski from Portland State University, Oregon, USA for providing access to his lecture notes on reversible logic and his valuable comments in the early stages of this research.

Also, I would like to thank Dr. Michael Miller from University of Victoria, Victoria, Canada for his help and participation in the research done in chapters 4 and 5 while he was on sabbatical in the University of New Brunswick.

Finally, I would like to thank my scientific advisor Gerhard W. Dueck from University of New Brunswick, New Brunswick, Canada for his support, help and active participation in the research.

Glossary

AND — Boolean operation ($\&$, concatenation) with properties $0\&0 = 0\&1 = 1\&0 = 0$, $1\&1 = 1$;

CNOT — Controlled NOT gate, also known as the Feynman gate;

CPU — Central Processing Unit;

EXOR — Boolean operation (\oplus) with properties $0 \oplus 0 = 1 \oplus 1 = 0$, $0 \oplus 1 = 1 \oplus 0 = 1$;

ESOP — EXOR sum-of-products;

mEXOR — multiple EXOR reversible gates family;

NOT — Boolean operation ($\bar{}$) with properties $\bar{0} = 1$, $\bar{1} = 0$;

PLA — Programmable Logic Array;

RCMG — Reversible Cascades with Minimal Garbage;

RPGA — Reversible Programmable Gate Array.

Table of Contents

Abstract	ii
Acknowledgments	iv
Glossary	v
Table of Contents	vi
List of Tables	viii
List of Figures	ix
Chapter 1. Introduction	1
Chapter 2. Basic Definitions and Literature Overview	8
2.1 Boolean Algebra	8
2.2 Basic Definitions of the Reversible Logic	11
2.2.1 Network Structure	13
2.2.2 The Popular Reversible Gates: Fredkin and Toffoli	15
2.2.3 Several Other Reversible Gates	17
2.3 Overview of Reversible Logic Synthesis Methods	19
2.4 Related Work	24
Chapter 3. Reversible Cascades with Minimal Garbage	26
3.1 Minimal Garbage	28
3.1.1 Analysis of Garbage in Existing Methods	29
3.2 A New Structure: Reversible Cascades with Minimal Garbage	32
3.2.1 Definition of the Model	32
3.2.2 Quantum Cost Analysis	35
3.2.3 Theoretical Synthesis	38
3.3 Heuristic Synthesis	45
3.3.1 The Algorithm	50
3.3.2 Multiple Output Functions	52
3.3.3 Benchmarks	52
3.4 RCMG and ESOP Comparison	57
3.4.1 Multiple Output Functions	65
3.5 Conclusions	65
Chapter 4. Toffoli Synthesis	66
4.1 The Algorithm	67
4.1.1 Basic Algorithm	67
4.1.2 Bidirectional Algorithm	71
4.2 Templates	73

4.2.1	Unification of Class 1 and Class 2 Templates	78
4.3	Templates - a New Approach	79
4.3.1	Completeness	85
4.4	Experimental Results	86
Chapter 5.	Toffoli-Fredkin Synthesis	90
5.1	How Useful Are Fredkin Gates?	90
5.2	Box Gate	91
5.2.1	A Note on Similarity of Fredkin And Toffoli Gates	93
5.3	The algorithm	94
5.3.1	Handling permutations	103
5.3.2	Multiple output and incompletely specified functions	104
5.4	Template simplification tool	104
5.5	Results	111
5.6	Conclusion	115
Chapter 6.	Asymptotically Optimal Regular Synthesis	117
6.1	Quantum Cost of the mEXOR gate	118
6.2	Asymptotically Optimal Reversible Synthesis Method	122
6.3	Conclusion	127
Chapter 7.	Dynamic Programming Algorithms as Reversible Circuits: Sym-	
	metric Function Realization	131
7.1	Application: Multiple Output Symmetric Functions	133
7.2	Comparison of the Results	139
7.3	Conclusion	142
Chapter 8.	Summary	143
Chapter 9.	Further Research	145
Bibliography		148

List of Tables

2.1	Truth table method	9
2.2	Truth table for a 3-input 3-output function	10
2.3	Reversible function computing the logical AND	12
3.1	Experimental results	31
3.2	Truth table	34
3.3	Gate cost comparison	39
3.4	Truth table of $f(x_1, x_2, x_3) = (x_1 \oplus \bar{x}_2x_3, \bar{x}_2, x_1 \oplus x_2x_3)$	46
3.5	Distance between f and its partial realization	47
3.6	Effect of changing one bit	49
3.7	Comparison with Miller's results	54
3.8	Comparison with Perkowski's results	55
3.9	Comparison with Khan's results	56
3.10	Complexity of the function $exphard_n$	64
4.1	Example of applying the basic algorithm.	69
4.2	Example of applying the bidirectional algorithm.	73
4.3	Second gate building process	79
5.1	Optimal synthesis of all 3-input 3-output functions	91
5.2	Basic approach synthesis.	101
5.3	Bidirectional approach synthesis.	103
5.4	Results	115
6.1	Cost comparison.	121
6.2	Circuit building process for a four variable function.	129
6.3	Circuit for the basic approach.	130
7.1	Comparison of the results to RWC, KGF and GT	140

List of Figures

2.1	The general structure for a network	14
2.2	NOT, CNOT and Toffoli gates	16
2.3	SWAP gate realization in quantum technology	17
3.1	Reversible design methods	30
3.2	Horizontal line types.	32
3.3	A single gate	33
3.4	Circuit	34
3.5	Pruned circuit	36
3.6	Building a network	43
3.7	Reversible design structure.	59
4.1	Circuit for the function shown in Table 4.1.	69
4.2	Circuits for the function shown in Table 4.2	72
4.3	Templates with 2 or 3 inputs.	75
4.4	Toffoli templates.	77
4.5	All templates for $m \leq 7$	83
4.6	All templates for $m \leq 7$ depicted as donuts.	84
4.7	Optimal circuit for a full adder.	87
4.8	Circuit for <i>rd53</i>	88
5.1	Toffoli, Fredkin and box gates.	92
5.2	Transformation of a Toffoli circuit to a NOT-Fredkin circuit.	94
5.3	Circuits.	104
5.4	Class AA.	106
5.5	Class ABAB.	107
5.6	A group of semi passes.	109
5.7	Fredkin definition group.	109
5.8	Link group.	110
5.9	Class <i>ATATB</i>	111
5.10	Class <i>FTTFTT</i>	112
5.11	Simplified networks.	113
5.12	Simplifying one network into the other.	114
6.1	Example of a mEXOR Toffoli gate.	119
6.2	Construction of a single mEXOR gate.	120
6.3	mEXOR gate network.	125
7.1	Circuit for <i>rd53</i>	138

Chapter 1

Introduction

Energy loss is an important consideration in digital circuit design, also known as circuit synthesis. Part of the problem of energy dissipation is related to technological non-ideality of switches and materials. Higher levels of integration and the use of new fabrication processes have dramatically reduced the heat loss over the last decades. The other part of the problem arises from Landauer's principle [34, 26] for which there is no solution. Landauer's principle states that logic computations that are not reversible necessarily generate $kT * \log 2$ Joules of heat energy for every bit of information that is lost, where k is Boltzmann's constant and T the absolute temperature at which computation is performed. For room temperature T the amount of dissipating heat is small (i.e. $2.9 * 10^{-21}$ Joules), but not negligible. This amount may not seem to be significant, but it will become relevant in the future. Consider heat dissipation due to the information loss in modern computers. First of all, current processors dissipate 500 times this amount of heat [56] every time a bit of information is lost. Second, assuming that every transistor out of more than $4 * 10^7$ [18] for Pentium-4 technology dissipates heat at a rate of the processor frequency, for instance 2 GHz ($2 * 10^9$ Hz), the figure becomes $4 * 10^{19} * kT \ln 2$ J/sec. The processor's working temperature is greater than 400 degrees Kelvin, which brings us to $24 * 10^{21} k \ln 2$. Although this amount of heat

is still small ($k \approx 1.38 * 10^{-23}$), i.e. only around 0.1 W, Moore's law [55] predicts exponential growth of the heat generated due to the information loss, which will be a noticeable amount of heat loss in the next decade. A more accurate (verified in parts with Intel's principal engineer Jason C. Stinson) heat dissipation due to the information loss calculation for the Madison Itanium-2 processor [80] showed the figure of at least 0.147 W when the processor is fully loaded.

Design that does not result in information loss is called reversible. It naturally takes care of heating generated due to the information loss. Bennett [5] showed zero energy dissipation would be possible only if the network consists of reversible gates. Thus reversibility will become an essential property in future circuit design. For reversible logic history refer to [6].

Quantum computations are known to solve some exponentially hard problems in polynomial time [56, 16]. All quantum computations are necessarily reversible [56, 66]. Therefore research on reversible logic is beneficial to the development of future quantum technologies: reversible design methods might give rise to methods of quantum circuit construction, resulting in much more powerful computers and computations.

Quantum technologies [57, 77, 62, 31, 32, 30, 35, 68, 69] are not the only ones that may (naturally) use reversibility, there are other technologies for which reversible implementations are known. Specifically, it was shown that reversible gates can also be built using technologies such as CMOS [46, 83, 10, 86], in particular adiabatic CMOS [3], optical [63, 65], thermodynamic technology [48], nanotechnology [46, 47], and DNA technology [65]. The billiard ball model [14, 6] is a model for reversible computations,

which among others, was simulated with reversible cellular arrays [38]. It happens that reversible logic naturally appears in many applications that initially do not seem to be connected to reversible logic at all, such as complex antenna simulations [76]. But the essence of the simulation, a process of propagating a wave, is essentially a reversible transformation. We do not discuss the different technologies in detail, since some of their descriptions involve deep knowledge of physics, electronics, circuitry, quantum mechanics, optics, thermodynamics and other physical/engineering subjects.

Most gates used in digital design are not reversible. For example the AND, OR and EXOR gates do not perform reversible operations. Of the commonly used gates, only the NOT gate is reversible. A set of reversible gates is needed to design reversible circuits. Several such gates have been proposed over the past decades. Among them are the *controlled-not* (CNOT) proposed by Feynman [13], Toffoli [82], and Fredkin [14] gates. These gates have been studied in detail. However, good synthesis methods have not emerged. Shende *et al.* [74, 75] suggest a synthesis method that produces a minimal circuit with up to 3 input variables. Iwama *et al.* [22] describe transformation rules for CNOT based circuits. These rules may be of use in a synthesis method. Miller [49] uses spectral techniques to find near optimal circuits. Mishchenko and Perkowski [54] suggest a regular structure of reversible wave cascades and show that such a structure would require no more cascades than product terms in an ESOP (“exclusive or” sum of products) realization of the function. In fact, one would expect that a better method can be found. The algorithm sketched in [54] has not been implemented. A regular symmetric structure has been proposed by Perkowski *et al.* [60] to realize symmetric functions. The reversible logic design algorithms will be considered in the Literature

Overview chapter in detail.

Traditional design methods use, among other criteria, the number of gates as a complexity measure (sometimes taken with some specific weights reflecting the area of the gate). From the point of view of reversible logic we have one more factor which is more important than the number of gates used, namely the number of garbage outputs. Since reversible design methods use reversible gates, where the number of inputs is equal to the number of outputs, the total number of outputs of such a network will be equal to the number of inputs. The existing methods [54] use the analogy of copying information from the input of the network, therefore introducing garbage outputs—information that we do not need for the computation. In some cases garbage is unavoidable. For example, a single output function of n variables will require at least $n - 1$ garbage outputs, since reversibility necessitates an equal number of outputs and inputs.

The importance of minimizing garbage is illustrated with the following example. Say we want to realize a 5 input 3 output function in a reversible method on a quantum computer, but the design requires 7 additional garbage outputs (that is 5 constant inputs), resulting in a 10-input 10-output reversible function. In the year 2002 the best quantum computer has 7 qubits [1], therefore we will not be able to implement this design. In other words, in the case of choosing between increasing the garbage and increasing the number of gates in a reversible implementation, the preference should be given to the design method delivering the minimum amount of garbage. In this case we will be able to build the device, while it is impossible with the other method.

The presented work is organized as follows.

- In the chapter **Basic Definitions and Literature Overview** the classic objects from reversible logic theory are defined. With this introductory part the reader becomes familiar with the objectives and notations of reversible logic theory. Previous work is analyzed and summarized in this section. As an important part of this summary, the weaknesses of previous approaches are pointed out.
- The first step in our research is the attempt to minimize the garbage that is the major weakness in all existing methods. The chapter **Reversible Cascades with Minimal Garbage** is focused on the conditions for minimal garbage, introduces and analyzes the new model that allows synthesis with minimal garbage, suggests possible design algorithms for both reversible and multiple output functions, discusses implementation of the algorithms and results of their testing, compares the proposed algorithms to known ones, and analyzes the quantum cost of the model. Finally, we compare efficiency of the new model to the efficiency of a popular model for non-reversible synthesis, EXOR PLA (“exclusive or” programmable logic array [70]). The results of the RCMG model and synthesis using it can be found in three of our works: [11], [45], [40] and Miller’s work [50].
- In the next chapter, **Toffoli Synthesis**, the conventional Toffoli gates were chosen to form the set of model gates. We create a theoretical synthesis method that initially produces acceptable size networks and show its modification, the bidirectional algorithm. Since, even after the bidirectional algorithm successfully terminates the circuit may still not be optimal, the following heuristic simplification procedures are applied: output permutation, control input reduction, choosing between realizing f and inverting the network for f^{-1} , applying a template tool.

The last simplification procedure seems to be the most promising from the point of view of the network simplification, therefore the templates are properly defined, classified, and applied. For some small parameters the set of all templates is completely built. The algorithm and simplification procedures are implemented and tested on benchmark functions. In addition to the commonly used benchmark functions we also create our own benchmark functions, the functions for which the method produces a large network and analyze why it happens. Some of the results of this chapter can also be found in our works [51, 42] and [43].

- The Toffoli gates are not the only gates that are widely used. There are also such gates as the Fredkin gate, Miller gate, Kerntopf gate and many more. The Fredkin gate can be generalized and incorporated into the algorithm initially designed for Toffoli network synthesis. In the chapter **Toffoli-Fredkin Synthesis** both versions of the algorithm and all the simplification procedures from the previous chapter are updated and applied to the new network model consisting of Toffoli and Fredkin gates. The new family of gates differs from the Toffoli gates only, therefore the new template classification is shown. Again, the results were implemented and tested on benchmark functions. As part of this testing, the results of the algorithm application are compared with the optimal Toffoli-Fredkin networks for all 3-input 3-output reversible functions. Part of the research done in this chapter can be found in the following of our publications [51, 12, 41].
- Most of the classical synthesis methods for the conventional logic synthesis are asymptotically optimal. Reversible logic is a new area and it does not have an asymptotically optimal synthesis method. In the chapter **Asymptotically Opti-**

mal **Regular Synthesis** we introduce a new mEXOR model and show an optimal synthesis (in terms of the number of gates used in the resulting design) method for it. We also show that technologically it is not expensive to create the gates for this new model, in fact their quantum cost differs only marginally from the quantum cost of conventional Toffoli gates. This chapter has been published as [39].

- The chapter **Dynamic Programming Algorithms as Reversible Circuits: Symmetric Function Realization** talks about synthesizing some recursive functions as a network of Toffoli gates. An example of recursive functions is the set of symmetric functions. We show how to build inexpensive quantum circuits for any multiple output symmetric function.
- The chapter **Further Research** points to the directions of the further research in the reversible logic area.
- The dissertation concludes with the chapter **Summary** which highlights the accomplishments described in this thesis.

Chapter 2

Basic Definitions and Literature Overview

2.1 Boolean Algebra

We start with a brief overview of Boolean logic. There are two Boolean constants, 0 and 1. One method to describe (and, therefore, define) a Boolean function $f(x_1, x_2, \dots, x_n)$ of n variables is by a truth table. This construction is a table with $(n + 1)$ columns and 2^n rows. In the rightmost column the value of the function for the input that is placed in the first n columns is given for each row. The number of different inputs for a function of n Boolean variables is 2^n , therefore the height of this construction is 2^n . In other words, the truth table has 2^n rows. Note that all the 2^n Boolean patterns are arranged in lexicographical order, and this reflects the conventional way of writing the truth table. It can be seen that the truth table requires a lot of storage space though the information about the order of inputs is not important, since it can be easily restored from the information on which string of the truth table are we looking at. In order to simplify the format, the truth vector method is used. The truth vector for a function of n variables is the sequence of Boolean numbers of length 2^n , where the k -th number of this sequence is the value of the function on the input that is the binary representation of number $(k - 1)$. In the following example we see the advantage of the truth vector

method of representing a function compared with the truth table method.

Example 1. Consider the following truth table shown in Table 2.1. The truth vector for

x_1	x_2	x_3	$f(x_1, x_2, x_3)$
0	0	0	0
0	0	1	0
0	1	0	1
0	1	1	1
1	0	0	1
1	0	1	0
1	1	0	1
1	1	1	1

Table 2.1: Truth table method

the same function is $[0, 0, 1, 1, 1, 0, 1, 1]$, which requires one-fourth of the storage space.

For a function of n variables the truth vector method requires $(n + 1)$ times less writing than the truth table, so we will use the truth vector notation everywhere when it is convenient.

By analogy one can define an n -input k -output multiple output Boolean function $(f_1(x_1, x_2, \dots, x_n), f_2(x_1, x_2, \dots, x_n), \dots, f_k(x_1, x_2, \dots, x_n))$ as a truth table with $(n + k)$ columns, where the last k columns represent the function output for the input pattern contained in the first n columns. Equivalently, n -input k -output multiple output Boolean function is a vector-function of k Boolean functions. A multiple output function can also be written as a truth vector. In this case each of the 2^n elements (coordinates)

of this vector is an integer number in the interval $[0, 2^k - 1]$ which is the binary representation of the output pattern.

Example 2. The 3-input 3-output multiple output Boolean function given in Table 2.2 has the truth vector $[0, 1, 2, 3, 4, 5, 7, 6]$.

x_1	x_2	x_3	f_1	f_2	f_3
0	0	0	0	0	0
0	0	1	0	0	1
0	1	0	0	1	0
0	1	1	0	1	1
1	0	0	1	0	0
1	0	1	1	0	1
1	1	0	1	1	1
1	1	1	1	1	0

Table 2.2: Truth table for a 3-input 3-output function

It is also possible to write functions as formulas. The operations of conjunction (written as $\&$ or concatenation), negation ($\bar{\quad}$) and exclusive or (\oplus , EXOR) are used. The popular notation $x_i^{\sigma_i}$ represents x_i if $\sigma_i = 1$ and \bar{x}_i if $\sigma_i = 0$.

For more information on Boolean logic see [70, 84].

2.2 Basic Definitions of the Reversible Logic

The main object in reversible logic theory is the reversible function, which is defined as follows.

Definition 1. The multiple output Boolean function $F(x_1, x_2, \dots, x_n)$ of n Boolean variables is called reversible if:

1. the number of outputs is equal to the number of inputs;
2. any output pattern has a unique preimage.

In other words, reversible functions are those that perform permutations of the set of input vectors.

Example 3. A 2-input 2-output function given by formula $(x, y) \rightarrow (\bar{x}, x \oplus y)$ or truth vector $[2, 3, 1, 0]$ is reversible. The correctness of this statement can be verified by analyzing the truth table below.

x	y	\bar{x}	$x \oplus y$
0	0	1	0
0	1	1	1
1	0	0	1
1	1	0	0

Example 4. A 2-input 1-output function $(x, y) \rightarrow x \oplus y$ is not reversible, since it is not an n -input n -output function. However, it can easily be made reversible by adding output \bar{x} . Note, that for this example we do not need to add an input.

Example 5. Consider the function $(x, y) \rightarrow xy$ (where concatenation denotes the logical AND operation). It is impossible to make it reversible by adding a single output, which can be verified by exhaustively trying all the possible assignments. One way to make it reversible is to add one input and two outputs so that the function becomes as shown in Table 2.3. The output vector of the desired function can be observed in the third output column of the table when the value of variable $z = 0$ (shown in bold font). To realize the function, the input z must be the constant zero, and two garbage outputs are present. The Toffoli gate [82] realizes this function.

x	y	z	x	y	$z \oplus xy$
0	0	0	0	0	0
0	0	1	0	0	1
0	1	0	0	1	0
0	1	1	0	1	1
1	0	0	1	0	0
1	0	1	1	0	1
1	1	0	1	1	1
1	1	1	1	1	0

Table 2.3: Reversible function computing the logical AND

The previous examples show the necessity of adding inputs and/or outputs to make a function reversible. This leads to the following definition.

Definition 2. Garbage is the number of outputs added to make an n -input k -output

function $((n, k)$ function) reversible.

We use the words “constant inputs” to denote the preset value inputs that were added to an (n, k) function to make it reversible. In the previous example a single constant input was added, namely the variable z with value 0. In general, if a reversible implementation with “constant inputs” of a function is given, the function itself can be calculated by assigning zeros and ones to the “constant inputs”.

The following simple formula shows the relation between the number of garbage outputs and constant inputs

$$\text{input} + \text{constant input} = \text{output} + \text{garbage}.$$

2.2.1 Network Structure

No fan-outs and no feed-back is a natural restriction for building quantum networks, and reversible logic is usually considered with the quantum technology in mind. Thus, due to existing technological restrictions also likely for incompletely developed technologies, the synthesis of reversible logic is done with the conventional agreements: no feed-backs and no fan-outs are allowed [56]. This leaves us with the cascade structure as the only model satisfying those conditions. (A cascade is any circuit with S gates G_1, G_2, \dots, G_S where no two gates are activated at the same time: G_i works only when G_{i-1} has produced an output. In other words, cascade defines a total order on the set of gates induced by the signal propagation timing.) Let the signal be propagated from left to right. The pictorial representation of a network (circuit) is shown in Figure 2.1. The cost of a function is defined as the number of gates in a circuit realizing it (S for the network structure in Figure 2.1). Note, the cost defined here is different from the quantum cost

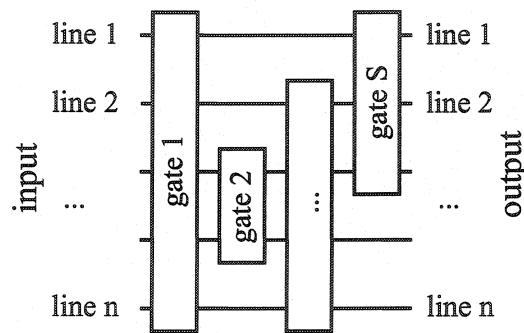

Figure 2.1: The general structure for a network

that will be defined later. In order to differentiate between them, the last will always be used as a two word term.

The structure of a reversible network, therefore, is defined as a cascade. Such a restriction makes the design difficult, but allows us to formulate the following Lemma.

Lemma 1. Given a network for a reversible function f , if the signal in it is propagated backwards the output function is the inverse of f , f^{-1} .

The proof of this Lemma is trivial, since both propagating the signal backwards and finding the inverse is essentially the same operation. The Lemma itself may require a correctness proof, in other words, justification of the fact that the signal can be propagated backwards. We deal with reversible logic which means that one can restore the input pattern of a gate given its output. This means that the signal can be propagated backwards, showing the correctness of the Lemma statement. In conventional non-reversible logic design it is impossible to propagate the signal backwards due to the irreversibility of most of the gates used.

When the topology of the network is defined, the set of all possible circuit designs is

strongly restricted. The only thing that we may still vary is which transformations the actual gates may do. The transformations themselves are strongly dependent on the size of a gate.

Definition 3. The size of a reversible gate is a natural number which shows the number of its inputs (outputs).

In the following subsections we introduce the gates starting from the most popular and widely used Toffoli and Fredkin gates and ending with the more recent and less used Picton gate, Kerntopf gate, Miller gate, Khan gate, etc.

2.2.2 The Popular Reversible Gates: Fredkin and Toffoli

In this subsection we define the popular Toffoli and Fredkin gates.

Definition 4. For the set of domain variables $\{x_1, x_2, \dots, x_n\}$ the **generalized Toffoli gate** has the form $TOF(C; T)$, where $C = \{x_{i_1}, x_{i_2}, \dots, x_{i_k}\}$, $T = \{x_j\}$ and $C \cap T = \emptyset$. It maps a Boolean pattern $(x_1^0, x_2^0, \dots, x_n^0)$ to $(x_1^0, x_2^0, \dots, x_{j-1}^0, x_j^0 \oplus x_{i_1}^0 x_{i_2}^0 \dots x_{i_k}^0, x_{j+1}^0, \dots, x_n^0)$.

In the literature, a number of gates from the set of all generalized Toffoli gates were considered. The most popular are: the NOT gate ($TOF(x_j)$), a generalized Toffoli gate which has no controls; the CNOT gate ($TOF(x_i; x_j)$)[13], which is also known as the Feynman gate, a generalized Toffoli gate with one control bit; and the original Toffoli gate ($TOF(x_{i_1}, x_{i_2}; x_j)$)[82], a generalized Toffoli gate with two controls. The three gates are illustrated in Figure 2.2, and the gates with more controls are drawn similarly. Note that the way the gates are drawn is a convention which is not related to the way

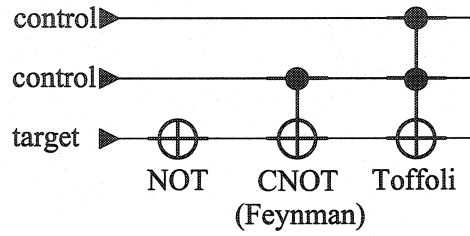

Figure 2.2: NOT, CNOT and Toffoli gates

the gates are implemented. Gates with more than two controls are discussed in [56, 39]. The set of generalized Toffoli gates is proven to be complete (for example, see [45]); in other words, any reversible function can be realized as a cascade of Toffoli gates.

Definition 5. For the set of domain variables $\{x_1, x_2, \dots, x_n\}$ the **generalized Fredkin gate** has the form $FRE(C;T)$, where $C = \{x_{i_1}, x_{i_2}, \dots, x_{i_k}\}$, $T = \{x_j, x_l\}$ and $C \cap T = \emptyset$. It maps a Boolean pattern $(x_1^0, x_2^0, \dots, x_n^0)$ to $(x_1^0, x_2^0, \dots, x_{j-1}^0, x_l^0, x_{j+1}^0, \dots, x_{l-1}^0, x_j^0, x_{l+1}^0, \dots, x_n^0)$ if and only if $x_{i_1}^0 x_{i_2}^0 \dots x_{i_k}^0 = 1$. In other words, the generalized Fredkin gate interchanges bits x_j and x_l if the corresponding product of C equals 1.

Several cases of the generalized Fredkin gates can be found in the literature. A gate with no controls, $FRE(x_1, x_2)$, is usually called SWAP since it swaps the signals on x_1 and x_2 . For some technologies the SWAP is done for free, for others there is a cost associated with it. For example, in CMOS there is no cost for interchanging the two wires. In contrast, in quantum technology the best one can do to interchange the values on two wires is to apply 3 CNOT gates as it is shown in Figure 2.3. Depending on the application we will refer to this gate as having a cost or not.

The classical Fredkin gate (the way it was originally presented [14]) has one control and

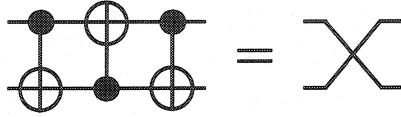

Figure 2.3: SWAP gate realization in quantum technology

can be written as $FRE(x_1, x_2, x_3)$.

For both gates defined above set C will be called the set of **controls** and T will be called the **target**. The number of elements in the set of controls C defines the **width** of the gate.

2.2.3 Several Other Reversible Gates

There were some more reversible gates proposed in the literature.

The Kerntopf gate [23, 25] is a reversible gate of size 3 which for the inputs x, y and z produces the output $(1 \oplus x \oplus y \oplus z \oplus xy, 1 \oplus y \oplus z \oplus xy \oplus yz, 1 \oplus x \oplus y \oplus xz)$. Unfortunately, no good implementation of this gate is known, so it is not used very often. A size k generalization of this gate was considered in [29, 52].

The Miller gate, initially considered as a benchmark function for the spectral techniques synthesis method in [49] has a specification given by the truth vector [0, 1, 2, 4, 3, 5, 6, 7]. The circuit of Toffoli gates of size five and quantum complexity 9 was initially proposed as a structural representation of this gate, but later on quantum circuits of size 7 were found [85]. This gate was recently introduced, so it is not used in the current synthesis procedures, but seems to be useful since it affects all three bits and its quantum cost is comparable to the quantum cost of the size 3 Toffoli gate (ratio of costs is 7 to 5) and quantum cost of the size 3 Fredkin gate (they have the same cost). It is not clear yet

how this gate can be generalized.

The recently introduced Khan gate [27] for the input vector (x_1, x_2, \dots, x_n) produces the output $(x_1, x_2, \dots, x_{n-2}, f x_{n-1} \oplus x_n, \bar{f} x_{n-1} \oplus \bar{x}_n)$ for an arbitrary function $f = f(x_1, x_2, \dots, x_{n-2})$. The function f is usually the \oplus or $\&$ of its arguments. For the second case (operation $\&$) the quantum complexity of such a gate was shown to be twice as much as the complexity of the Toffoli gate with $n - 2$ variables. This gate seems to be expensive and the existing synthesis procedure [28] requires a lot (growing asymptotically faster than the minimal amount of garbage bits will be shown to be) of garbage.

A newly shown majority-based reversible gate [85] is an odd size reversible gate, such that at least one output is a majority Boolean function of its inputs. A majority Boolean function is such a function that returns one if and only if more than half of its inputs are ones. This gate seems complex in the classical Boolean circuit realization, and its realizations in a reversible technology are not known yet. The Miller gate is a case of a majority-based reversible gate.

The Picton gate [64] is a multi-valued logic generalization of a Fredkin gate. It is not useful at this point since no multiple-valued reversible logic synthesis methods are designed yet. No implementation of the Picton gate is known yet.

Among other existing gates are the Perkowski gates [29, 62], Margolus gates [24], and DeVos gates [25]. We do not introduce these gates here, since to the best of our knowledge they were not yet used. However, one of the gates Perkowski mentions in [62] seems to be a useful one, since for the input (x_1, x_2, x_3) it produces the output $(x_1, x_1 \oplus x_2, x_3 \oplus x_1 x_2)$

when a quantum circuit with cost only 4 (which is less than the cost of a Toffoli gate) was found. Perkowski also states [62] that this implementation was known to Peres [57].

2.3 Overview of Reversible Logic Synthesis Methods

Such a variety of different reversible gates results in a variety of different approaches to reversible logic synthesis. Fortunately, the basic analysis of different techniques of reversible logic synthesis was successfully done in one of Perkowski's work [85]. Here, we use and expand this approach to the classification of reversible synthesis methods.

1. Composition methods [54, 59, 45, 11, 51, 12]. The idea is to compose a reversible block using small and well known reversible gates. The reversible block should be easy to use. Then, a modification of a conventional logic synthesis procedure is applied to synthesize a network. The resulting network will be reversible as a network essentially consisting of reversible gates.
2. Decomposition methods [59, 45]. Decomposition methods can be characterized as a top-down reduction of the function from its outputs to its inputs. During the design procedure a function is supposed to be decomposed into a combination of several specific functions each of which is realized as a separate reversible network. An example of a decomposition method can be found in [45] where synthesis appears to be a reduction of the output to the form of the input.

The decomposition and composition methods can be multilevel. Observe that the composition and decomposition methods form a very general and powerful tool of logic synthesis. In fact, most of the algorithms can be classified as either composition or decomposition. Using Lemma 1, one can notice the duality of the

composition and decomposition methods; a composition design procedure for a reversible function f is a decomposition procedure for f^{-1} .

3. Factorization methods [28]. Factorization is another powerful logic design tool. Its idea is in choosing a Boolean operation, for instance, \star (often multiplication or EXOR) for a function f and finding two functions f_1 and f_2 such that:

- $f = f_1 \star f_2$;
- for the synthesis cost metrics the cost of f is smaller than the sum of costs of f_1 and f_2 plus a weight associated with the \star operation.

In general, the \star operation does not have to be a binary operation, but may be an arbitrary multiple output function of several arguments. To our knowledge, the factorization tool was first applied to reversible logic design in [28].

4. EXOR logic based methods [22, 59, 74, 75, 51, 42]. The Toffoli gate uses the EXOR operation in its definition since when it is used the gate can be described as a simplest formula. Usage of the properties of the EXOR operation such as:

- $a \oplus b = b \oplus a$;
- $a \oplus 0 = a$;
- $a \oplus 1 = \bar{a}$;
- $a \oplus a = 0$;

allows heuristic synthesis [59] and simplification of the already created networks [22, 74, 75, 51, 42]. For example, Iwama *et al.* [22] describe transformation rules for CNOT based circuits. The input of their method is a reversible circuit of

Toffoli elements, and the output is a canonical form reversible circuit of the Toffoli elements. This canonical form is a straightforward reversible implementation of PPRM (Positive Polarity Reed-Muller expansion), also known as a Zhegalkin polynomial. Iwama *et al.* [22] prove that any circuit can be brought to a canonical form by certain (reversible) operations, thus a canonical form can be transformed to a minimal circuit. Unfortunately, they do not provide any method of simplifying a circuit by the set of transformations they have, so the paper is more for theoretical interest. In general, the EXOR operation is very hard to analyze (in fact, the best Boolean EXOR polynomials were found only for functions of at most 6 variables [15]), therefore only heuristic approaches currently work.

5. Genetic algorithms [36, 62]. The general idea behind genetic algorithms is emulation of the evolution process. First, several possible solutions or initial guesses are coded by strings and the fitness function is defined. The fitness function represents the probability of “survival” of a string. The strings which are close to the desired solution usually have a high fitness value. At the first part of the life cycle, a crossing over operation is used to create the new strings out of the set of strings available. At the second stage, mutation operations are applied. The cycle finishes with the application of the fitness operation, which takes away some of the strings. The new cycle begins. After several applications of this cycle (several generations) the strings with the best fitness value are read. These genetic algorithms have a lot of formulations and their actual implementations may vary. Their main weakness is their extremely bad scaleability.
6. Search, backtracking, simulated annealing, etc. [29, 54, 59, 11, 12]. Backtracking

or look-ahead techniques are widely used in heuristic approximations of a desired object. Their fundamental characteristic is in considering several steps ahead and making a decision on a small change based on the information that this change may result in. This technique is very expensive to use, since each vertex of the decision tree branches and the size of the search space grows exponentially with only a linear increase in the depth of the search. Simulated annealing is an idea that comes from the cooling of metals. If the liquid metal is cooled very fast, the structure of its lattice will not be regular and it will be easy to break such a metal. If during the cooling process the metal is cooled and then slightly warmed, then cooled and again warmed a little, and so on, the final molecular lattice of the metal detail will be more regular, thus resulting in higher durability and robustness. The same idea may work with circuit design: take a circuit and start expanding and reducing it without changing its output functionality. After a certain number of such operations, a more compact circuit may be found.

7. Group-theoretic methods including use of algebraic software such as GAP [73, 81, 85]. The set of all reversible functions forms a non-Abelian group (denoted S_n) with respect to the composition operation. The group of all permutations of n elements S_n is very well investigated. The first nice property of the group is that if a reversible function f can be written as a composition of several other permutations $f = f_1 \circ f_2 \circ \dots \circ f_k$, its circuit is a cascade of circuits for f_1, f_2, \dots, f_k . So, circuit design is equivalent to the problem of finding a simple composition of easy to build permutations. Small size generating sets can be found for the group of all permutations, therefore producing a small and complete set of gates. In other

words, searching for new gates is possible with a group theoretic approach. In our opinion, group theoretical approaches have not been investigated at a proper level yet. One of the unavoidable weaknesses of this approach is its need for a reversible specification.

8. Synthesis of regular structures such as nets [60, 61], lattices [2], and PLAs [65].

The idea behind these methods is creating conventional logic design objects out of reversible components and then applying the known techniques of logic synthesis to create reversible specifications. Such methods usually have a very high amount of garbage which makes it impossible to use such designs in technologies with the high cost of garbage, such as quantum technology. Also, one would expect that reducing reversible synthesis to conventional non-reversible synthesis cannot produce good results due to the different nature of the objects.

9. Spectral techniques by Miller [49, 50]. The spectrum [21] of a Boolean function is

its correlation with the vector of length 2^n of all linear monotonically increasing functions. In both of his works, Miller applied a composition approach with the decision of choosing the gate based on the spectral complexity. If addition of a gate to a cascade decreases the spectral complexity, then it is added. In practice, such a gate has always existed. The method produces good results for small size reversible functions, but it has its weaknesses: it scales badly, and requires a reversible specification.

10. Exhaustive search [58, 74, 75]. Minimal circuits for reversible Boolean functions

of one variable are not interesting. There are only two reversible functions of one

variable: identity and NOT, which require 0 and 1 gates respectively. A search of minimal circuits of 2 variable reversible functions was done by Perkowski in his lecture notes [58] on reversible logic synthesis. Shende *et al.* [74, 75] search exhaustively for minimal circuits of all reversible functions of 3 variables. It can be shown that the number of reversible functions of n variables is $2^n!$, which for $n = 4$ becomes $2^4! = 16! = 20922789888000 \approx 2 * 10^{13}$. Even if each reversible function requires one bit of storage, this results in 2345 Terabytes of storage, which does not seem to be feasible with current technology. Thus, exhaustive search cannot go any further at the present time.

11. Non-regular a-priori synthesis procedures, when the synthesis of the small circuits is done mostly by hand [8].

2.4 Related Work

A few of the early presented works are similar to reversible logic. For example, interesting results were obtained by Sasao *et al.* in years 1976-1979 [33, 72]. The authors considered synthesis with multiple-output logic gates where the numbers of ones in the input and the output are equal. These works are not quite in the area of reversible logic, although reversibility implies equality of the number of ones in the input and output domain. The authors considered equality of the ones for any input-output correspondence (which, in some sense, can be treated as a power set of the set of reversible logic functions).

In the year 2003 Sasao [71] has published an algorithm of n -input Boolean one output multiple-valued function synthesis by reversible cascades. However, his mathematical

structure does not have a straightforward technological intuition, therefore these results are likely to stay theoretical.

In the 1960s, Lupanov [37] considered general synthesis theory with k -input s -output gates and with no fan-out restrictions. Thus, the structure of a network is a cascade, which is absolutely the same as in the reversible case. The difference is in the mandatory reversibility of a single building block for the reversible case. Such a restriction is not present in Lupanov's work. The mentioned paper is very general and further investigation is needed in order to be able to apply the published results to reversible logic and its synthesis. Also, a high amount of garbage is expected to be added, which makes it unlikely that the results will be applicable in a technology.

Chapter 3

Reversible Cascades with Minimal Garbage

There are many ways of making a multiple output Boolean function reversible, each requiring (in general) a different number of garbage outputs to be created. We start this chapter by analyzing the conditions that affect the number of garbage outputs. Minimization of the number of garbage outputs may be even more important for some technologies than minimization of the number of gates. For example, in current NMR (Nuclear Magnetic Resonance) quantum technology the maximum number of bits that can be used simultaneously for a computation is limited by 7 [1]. In some other technologies (Trapped Ion, Neutral Atom, Solid State, Superconducting, e-Helium, Spectral Hole Burning) introducing a garbage bit may be possible without any restriction on the number of bits added, however it is not easy to do [20]. In optic quantum technology garbage does not seem to cause a large problem [20].

We further analyze the garbage amount for existing synthesis methods. A conclusion of this analysis can be summarized in a few words: the garbage is excessive, therefore a different approach/model is created.

For this new model, first, and very important requirement, is few garbage outputs. What

we build, in fact, has theoretically minimal number of garbage bits. Second, the model gates should have a reasonable cost if implemented in at least one of the technologies that support reversible logic implementations. In this thesis, a paper by Barenco *et al.* [4] is used as a basis for quantum cost calculation. Unfortunately, Barenco *et al.* consider only an approximation for a quantum cost calculation, where any one-qubit and controlled-V gates [56] have a unit cost. Real quantum cost for a real technology is different, but research laboratories who possess tools for real quantum cost calculation do not want to share the information (partially because their quantum cost calculation are designed specifically for their unique equipment). However, paper by Barenco *et al.* gives reasonable approximation of the actual technological cost of the gates.

Finally, the results of the actual synthesis (that is, number of gates in a cascade) should not be large in comparison to the other synthesis method results. If such a model will be created, it may be very important for evolving further reversible logic theory and bringing its theoretical results to the actual technology (NMR-oriented).

In our new model we consider a generalization of the n -bit Toffoli gate, where input variables can be optionally negated. Negations are technologically easy operations, and the n -bit Toffoli gates have reasonably low (linear) cost. Thus, the model gates are not expensive and the second requirement for the model is satisfied. When the set of model gates is chosen and the geometry of the circuit is set (cascades in our case), then comes the problem of synthesis: given a multiple-output Boolean function, find a cascade of gates from the given model which realizes it. This problem is solved by the following procedure. First, find the minimal garbage required by the function to be reversible.

This number is independent of the synthesis model. Then, the ways of synthesis split into theoretical and practical. In theoretical, a minimal reversible specification of the given multiple output function is found. Then, a reversible function is synthesized by a procedure which always terminates with a valid circuit. This guarantees minimality of garbage, but the number of cascades in the resulting circuit may be large. Therefore, a practical approach was designed. It works as follows. When the amount of garbage for minimal reversible specification is found, the corresponding number of variables is added to the multiple output function without specifying them (“don’t cares”). The function then is synthesized heuristically based on the idea of decreasing Hamming distance by choosing a gate with the biggest decrease in distance. Such approach guarantees minimality of garbage and is capable of producing small circuits. Theoretically, this practical approach may never terminate. However, we used look ahead technique and the synthesis method did converge for all the examples that we tried.

3.1 Minimal Garbage

Before we analyze the garbage in other models, we need to show a formula to calculate the minimum amount of garbage.

Theorem 1. *For an (n, k) function the minimum amount of garbage required to make it reversible is $\lceil \log(M) \rceil$, where M is the maximum of number of times an output pattern is repeated in the truth table.*

Proof. The output of a reversible function is a permutation of its input. Therefore, the obstacle in having a multiple output function being reversible is that some output pattern appears more than once. In order to separate these outputs we have to introduce

new inputs to assign additional bits to the output vector. If an output (o_1, o_2, \dots, o_k) has the largest occurrence in the output vector and it appears M times, then in order to separate different occurrences of it we need to introduce $\lceil \log(M) \rceil$ new output bits. $\lceil \log(M) \rceil$ new bits will be capable of creating $2^{\lceil \log(M) \rceil} \geq M$ new patterns. And, since the output (o_1, o_2, \dots, o_k) had the largest occurrence among all other outputs, all other outputs can be easily separated from one another by means of $\lceil \log(M) \rceil$ bits. ■

3.1.1 Analysis of Garbage in Existing Methods

In this subsection we analyze garbage in proposed designs. Several of the proposed design methods (for example [29, 74, 75], and [49]) start with a reversible function. The garbage is introduced during a preprocessing phase, during which the function is made reversible. Note that there are many ways in which the value of the garbage outputs can be set. Different settings of these variables will lead to results with varying complexity.

Mishchenko and Perkowski [54] suggest a cascade reversible design, called reversible wave cascade. The design is shown in Fig. 3.1A. For the purposes of garbage analysis here we concentrate only on the number of garbage outputs added. Trivial analysis of the number of garbage bits shows that in the proposed model the garbage size will be $(n + M)$, where n is the number of inputs of the multiple output function f and M is the number of vertical cascades in the particular realization of a function. However, in an e-mail correspondence Perkowski explained that the zero constant input on the top can be ignored (which is not trivial from the paper), thus each vertical cascade itself does not introduce the new garbage. With this explanation, the garbage of Mishchenko and Perkowski [54] method becomes n , the number of inputs of the function to be realized.

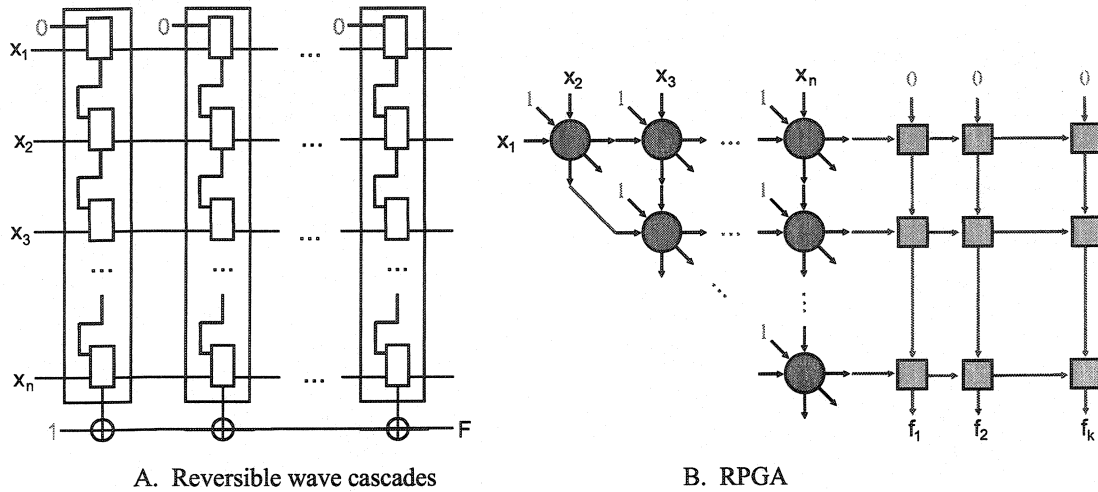

Figure 3.1: Reversible design methods

In Table 3.1 this (updated) garbage calculation is shown in brackets.

Perkowski *et al.* [60] suggest a regular structure for a symmetric (n, k) function reversible design, called RPGA (Fig. 3.1B.). The synthesis for a symmetric function, as it is easy to see from the structure Fig. 3.1B, will require garbage equal to the sum of the number of inputs and the number of gates used (additional wires are reserved for the outputs), which gives

$$n + \frac{n(n-1)}{2} = \frac{n(n+1)}{2}.$$

Khan and Perkowski [28, 27] propose a method which has a similar structure to the one described in [54]. The synthesis and garbage results for these methods are essentially the same, although later work has, on average, worse results both in the number of gates and the amount of garbage.

We calculated the number of garbage bits in the proposed model for some benchmark functions. The following table summarizes the result for the methods suggested in

[54, 60, 28] on some benchmark functions used in [54]. The first column shows the

name	in	out	RWCG	RPGAG	KPG	max out occur	min garbage
5xp1	7	10	38(7)	> 28	53	1	0
9sym	9	1	60(9)	45	60	420	9
b12	15	9	43(15)	> 120	41	6944	13
clip	9	5	72(9)	> 45	N/A	37	6
in7	26	10	61(26)	> 351	N/A	11651840	24
rd53	5	3	19(5)	15	19	10	4
rd73	7	3	43(7)	28	47	35	6
rd84	8	4	66(8)	36	68	70	7
sao2	10	4	38(10)	> 55	52	513	10
t481	16	1	29(16)	> 136	28	42016	16
vg2	25	8	209(25)	> 325	217	12713984	24

Table 3.1: Experimental results

name of the function, the second and third are the number of input and output bits respectively. The fourth column is the wave cascade method garbage amount. The fifth column is occupied by the number of garbage bits for the RPGA method given by the formula described above. Since every non-symmetric function can be made symmetric by adding new outputs, the procedure of making the function reversible can be done prior to the usage of the algorithm as Perkowski *et al.* [60] suggest. In general, such a procedure requires many additional inputs, each resulting in a high garbage price for their introduction. In cases where the function is not symmetric we use the sign “>”

to represent that the actual garbage amount is higher. Numbers in the sixth column represent the garbage cost of synthesizing the Khan family gates. The seventh column shows the maximal output occurrence, the logarithm of which added to the function input size forms the last, eighth column, which shows the minimal garbage to be added to make the corresponding function reversible.

We conclude this section with the observation that all three regular methods analyzed have garbage that is far from the theoretical minimum. In the next section we introduce a new regular structure with better garbage characteristics; in fact, the amount of garbage is theoretically minimal.

3.2 A New Structure: Reversible Cascades with Minimal Garbage

3.2.1 Definition of the Model

We consider the set of model gates which is a generalization of the generalized Toffoli gate. We use the same pictorial representation, and use (n, n) -gates where each horizontal line is one of the following 4 types (Fig. 3.2):

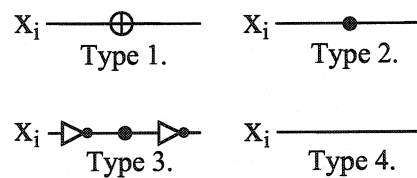

Figure 3.2: Horizontal line types.

1. Target line. Each gate should have only one target line appearing at some position j .

2. Positive control line. If the input on this line is zero, the value of the target line will not change. If the input is one, the other positive/negative control lines determine whether the value on the target line is negated.
3. Negative control line. If the input on this line is one, the value of the target line will not change. If the input is zero, the remaining positive/negative control lines determine whether the value on the target line is negated.
4. Don't care line. The value on this line does not affect any output.

The vertical line intersects horizontal lines of types 1-3. In other words, for the given set of inputs $\{x_1, x_2, \dots, x_n\}$, the subset of variables $\{x_{i_1}, x_{i_2}, \dots, x_{i_k}\}$, integer $j \in \{1, 2, \dots, n\}$, $j \neq i_1, j \neq i_2, \dots, j \neq i_k$ and set of $1 \leq k < n$ Boolean numbers $\{\sigma_1, \sigma_2, \dots, \sigma_k\}$ the family consists of gates that leave all the bits unchanged, except for the j -th bit, whose value is $x_j \oplus x_{i_1}^{\sigma_1} x_{i_2}^{\sigma_2} \dots x_{i_k}^{\sigma_k}$. If the term $x_{i_1}^{\sigma_1} x_{i_2}^{\sigma_2} \dots x_{i_k}^{\sigma_k}$ consists of zero variables, we assign it a value of 1.

The graphical representation of a gate is shown in Fig. 3.3.

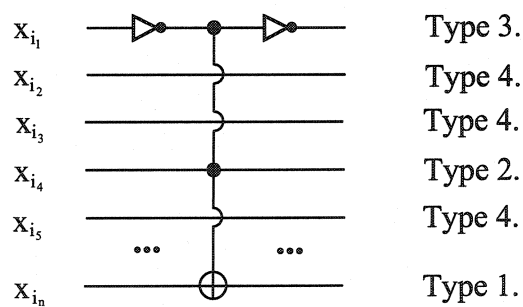

Figure 3.3: A single gate

The network we want to build is a cascade consisting of the set of described gates.

Example 6. Take a reversible function $(x_1, x_2, x_3) \rightarrow (x_1 \oplus \bar{x}_2 x_3, \bar{x}_2, x_1 \oplus x_2 x_3)$ (output is written as a set of minimal length EXOR polynomials). The fact that the function is reversible is easy to see from its truth table below. A possible implementation is shown

x_1	x_2	x_3	f_1	f_2	f_3
0	0	0	0	1	0
0	0	1	1	1	0
0	1	0	0	0	0
0	1	1	0	0	1
1	0	0	1	1	1
1	0	1	0	1	1
1	1	0	1	0	1
1	1	1	1	0	0

Table 3.2: Truth table

in (Fig. 3.4).

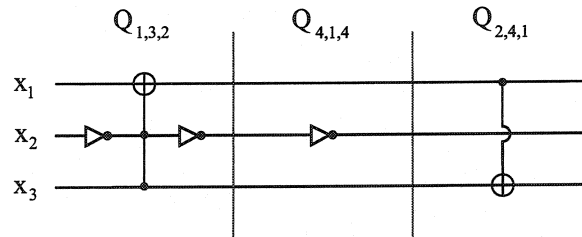

Figure 3.4: Circuit

Further, we refer to this model as RCMG (Reversible Cascades with Minimal Garbage).

3.2.2 Quantum Cost Analysis

Quantum technology is one of several technologies that uses reversible gates and computations. So, it is interesting to analyze the quantum cost of the introduced model to see whether and how it differs from the costs of the gates used by other models.

Quantum transformations are necessarily reversible, this follows from the only condition used to determine whether a transformation can be accomplished: it must be a unitary operator on the set of quantum state amplitudes [56]. This condition does not mention how difficult it is to realize a given unitary transformation; it only states the theoretical possibility.

In conjunction with reversible logic synthesis, the following transformations can be realized as one gate with unit cost:

- NOT gate (also known as quantum X gate). For Boolean entities it acts as the conventional NOT gate.
- CNOT gate, which acts as $TOF(x_1; x_2)$. In other words, in the Boolean case it flips x_2 iff $x_1 = 1$.

The set of gates NOT, CNOT is not complete since they only realize linear functions. Thus, in order to make the set complete (as a set of Boolean functions), the Toffoli gate [82], $TOF(x_1, x_2; x_3)$ was added. Unfortunately, this gate cannot be realized as a single elementary quantum operation. Quantum realization of a minimal cost of 5 was found, and it seems likely that this is the minimum. The more controls a generalized Toffoli gate has, the larger its cost in terms of the number of elementary quantum transformations required.

The problem of building quantum blocks to realize Toffoli gates was investigated by many authors. For a comparison of quantum costs of Toffoli and RCMG model gates we will use results of [4]. For other implementations the costs can easily be recalculated.

Definition 6. The quantum cost of a gate G , $|G|$ is the number of elementary quantum operations required to realize the function given by G .

No particular realization of a gate (for most of the gates) was proven to be optimal, so the numeric value of the quantum cost may change as soon as better gate realizations are proposed.

To analyze the quantum cost of an RCMG model gate, we should start with its simplification, and then compare its cost to the cost of a generalized Toffoli gate. Note that an RCMG model gate can be considered as a generalized Toffoli gate and a set of NOT operations. First, we should try to minimize the number of NOTs in the circuit.

The following method of eliminating NOT gates from the structure can be used. In some designs, like the one shown in Fig. 3.3, two NOT gates may be adjacent. Therefore, they are redundant. For the example from Fig. 3.4, pruning such a NOT gate gives the design shown in Fig. 3.5. In general, we divide any gate from the set Q into three

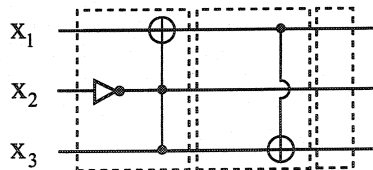

Figure 3.5: Pruned circuit

logical parts:

- First NOT array: the set of all NOT gates before the vertical line.
- AND-EXOR array (generalized Toffoli gate): the set of all AND and EXOR gates on the vertical line.
- Last NOT array: the set of all remaining NOT gates.

The general rule for pruning NOT gates is as follows:

1. Define TEMP array as an array of NOT gates of length n , such that there is at most one NOT gate at each place. Initially no NOT gate is present in the TEMP array.
2. Starting from the beginning of a particular network, keep NOTs from the first NOT array of a first $Q^1 \in Q$ gate together with the next AND-EXOR array and call this structure a block. The last NOT array of gate Q^1 is called TEMP. If Q^1 was one of $\bar{x}_1, \bar{x}_2, \dots, \bar{x}_n$, add it to TEMP.
3. Take the next gate $Q^2 \in Q$ from the network. If $Q^2 \notin \{\bar{x}_1, \bar{x}_2, \dots, \bar{x}_n\}$ update the TEMP array by computing its exclusive or with the first NOT array of Q^2 that is, keep the modulo-2 sum of number of NOTs at each wire. If the NOT gate from the TEMP array meets a target line or a “don’t care” line, it can be passed through the gate, so delete these occurrences from the TEMP array and add them to the output array of the Q^2 gate. Unite the TEMP array with the AND-EXOR array (create a new block), let $Q^1 := Q^2$ and go to step 2. If the Q^2 gate was one of gates $\bar{x}_1, \bar{x}_2, \dots, \bar{x}_n$, update TEMP array by computing the “exclusive or” of TEMP with Q^2 , let $Q^1 := Q^2$ and go to step 2.

4. When the network is over, create the last block by putting the TEMP array into it.

It is easy to see that the network consisting of the described blocks is equivalent to the network built from the gates Q . The number of blocks of the pruned network is the number of gates of the initial Q -network minus the number of gates from the set $\{\bar{x}_1, \bar{x}_2, \dots, \bar{x}_n\}$ of this Q -network plus the TEMP array. Therefore, both the set of NOT gates and the length of the structure can only be decreased.

The new gate will consist of the NOT array in front of the Toffoli gate, where the NOTs may appear only in front of the control lines, which makes it easy to compare the costs. The result of this comparison is summarized in Table 3.3. It is important to notice that the cost of the gate in the new model differs from the cost of the widely used generalized Toffoli gate only marginally. For example, the quantum cost of a Khan gate [28, 27] with k controls is equivalent to the cost of the two Toffoli gates, which, in a rough calculation, should multiply the cost of a circuit by 2 when compared to the synthesis results of RCMG model.

Note that the NOT pruning procedure is a post processing, which does not affect the way the synthesis will be done.

3.2.3 Theoretical Synthesis

In order to formulate and prove some results we need to enumerate the set of all gates considered in the structure. Every gate can be uniquely specified by describing the set of horizontal lines. From now on, we will use the notation Q_{a_1, a_2, \dots, a_n} for the gate consisting of wire types a_1, a_2, \dots, a_n in order of appearance from top to bottom.

Number of controls	garbage	Toffoli gate cost	RCMG gate cost \leq	Relative cost \leq	Average rel. cost
2	0	5	7	1.4	1.2
3	0	13	16	1.231	1.115
4	0	29	33	1.138	1.069
5	0	61	66	1.082	1.041
6	0	125	131	1.048	1.024
6	4	112	118	1.054	1.027
7	0	253	260	1.028	1.014
7	3	124	131	1.056	1.028
8	0	509	517	1.016	1.008
8	4	172	180	1.047	1.023

Table 3.3: Gate cost comparison

Lemma 2. The set of all possible gates in the proposed structure consists of $n * 3^{n-1}$ elements.

Proof. Distribute lines among the n places we have to fill in order to define a gate. Initially, there are n places for the target line; after assigning it, there are $(n - 1)$ places left to be occupied by positive, negative and “don’t care” lines to be placed in any combination. The number of ways to put them, therefore, is 3^{n-1} . This gives a total of $n * 3^{n-1}$ different gates. ■

Theorem 2. (lower bound) *There exists a reversible function that requires at least $\frac{2^n}{\ln 3} + o(2^n)$ gates.*

Proof. The number of all reversible functions of n variables is 2^{2^n} (as the number of permutations of 2^n elements). The number of different gates is $n3^{n-1}$. Assuming that taking some of the gates and building networks with different orders produces different reversible functions (which is not always true, since, for instance, the gate $Q_{1,4,4,\dots,4}$, or \bar{x}_1 placed two times at a row does nothing), we get a complexity for the hardest function of $\log_{n3^{n-1}}(2^{2^n})$. This means that there exists a reversible function which can be realized with a complexity not less than $\log_{n3^{n-1}}(2^{2^n})$. Using the formula $\ln(k!) = k \ln k - k + o(k)$ (which can be derived from Stirling's formula) for $k = 2^n$ write:

$$\begin{aligned} \log_{n3^{n-1}}(2^{2^n}) &= \frac{\ln(2^{2^n})}{\ln(n3^{n-1})} = \frac{2^n \ln 2^n - 2^n + o(2^n)}{\ln(3^{n-1}) + \ln(n)} = \frac{n2^n - 2^n + o(2^n)}{(n-1) \ln 3 + \ln(n)} \\ &= \frac{(n-1)2^n + o(2^n)}{(n-1) \ln 3 + \ln(n)} = \frac{2^n + o(2^n/n)}{\ln 3 + \frac{\ln(n)}{n-1}} = \frac{2^n}{\ln 3} + o(2^n). \end{aligned}$$

■

Theorem 3. (upper bound) *Every reversible function can be realized with no more than $n2^n$ gates.*

Proof. We use an idea similar to bubble sorting in our constructive proof.

First, note that the set of gates that do not have a “don't care” line, i.e. the set $Q' = \{q_{a_1, a_2, \dots, a_n} | a_1, a_2, \dots, a_n \in \{1, 2, 3\}, \text{ and there exists a unique } a_i = 1\}$ interchange the two output strings $(3 - a_1, 3 - a_2, \dots, 3 - a_{i-1}, x, 3 - a_{i+1}, \dots, 3 - a_n)$ and $(3 - a_1, 3 - a_2, \dots, 3 - a_{i-1}, \bar{x}, 3 - a_{i+1}, \dots, 3 - a_n)$ in the right part of the truth table (natural numbers

0 and 1 should be treated as Boolean 0 and 1 respectively). This also means that a single gate changes the two Hamming distance-one strings in the output part of the truth table.

Second, we define a special total order on the set Q' of gates. In this order:

- strings with a fewer number of ones precede (denoted as \prec) those with a larger number of ones;
- strings with an equal number of ones are arranged in lexicographical order.

In other words, the order is as follows: $(0, \dots, 0, 0) \prec (0, \dots, 0, 1) \prec (0, \dots, 0, 1, 0) \prec \dots \prec (1, 0, \dots, 0, 0) \prec (0, \dots, 0, 1, 1) \prec (0, \dots, 0, 1, 0, 1) \prec \dots \prec (1, 0, \dots, 0, 1) \prec \dots \prec (1, 1, \dots, 1, 0) \prec (1, \dots, 1, 1)$. We will also use standard order on Boolean constants: $0 \prec 1$.

The method is to copy the first part of the truth table to the second, which corresponds to the situation when no network is built yet, therefore the output is equal to the input. Then, apply operations defined by the gates from the set Q' to bring each string to its place, starting from the string with the lowest order and finishing with the string with the highest order.

Take any string (a_1, a_2, \dots, a_n) and bring it to its place. If the string is already at its place, we are done. If it is not, then since we are moving the strings in ascending order, its place is occupied by a string of higher order. This is true, since by induction the strings of lower order are already at their places and no string is repeated. Therefore, the place of (a_1, a_2, \dots, a_n) is occupied by a (b_1, b_2, \dots, b_n) . Compose string $(a_1 \vee b_1, a_2 \vee b_2, \dots, a_n \vee b_n)$.

Step 1: increase the order of the target. Take the string (b_1, b_2, \dots, b_n) , find minimal i , such that $a_i = 1$ and $b_i = 0$ and exchange distance-one strings (b_1, b_2, \dots, b_n) and $(a_1 \vee b_1, a_2 \vee b_2, \dots, a_i \vee b_i, b_{i+1}, \dots, b_n)$. Now, the place where we wanted to see (a_1, a_2, \dots, a_n) is occupied by $Inc_1 = (a_1 \vee b_1, a_2 \vee b_2, \dots, a_i \vee b_i, b_{i+1}, \dots, b_n)$. Now search for the smallest j such that $j > i$, $a_j = 1$ and $b_j = 0$ and when it is found, exchange $Inc_1 = (a_1 \vee b_1, a_2 \vee b_2, \dots, a_i \vee b_i, b_{i+1}, \dots, b_n)$ with higher order string $Inc_2 = (a_1 \vee b_1, a_2 \vee b_2, \dots, a_j \vee b_j, b_{j+1}, \dots, b_n)$. Continue these changes until we have string $Inc_k = (a_1 \vee b_1, a_2 \vee b_2, \dots, a_n \vee b_n)$ at the desired position of (a_1, a_2, \dots, a_n) .

Step 2: decrease the order of the source. Take string $(a_1 \vee b_1, a_2 \vee b_2, \dots, a_n \vee b_n)$, find minimal i , such that $a_i = 0$ and $a_i \vee b_i = 1$ and exchange distance-one strings $(a_1 \vee b_1, a_2 \vee b_2, \dots, a_n \vee b_n)$ and $(a_1, a_2, \dots, a_i, a_{i+1} \vee b_{i+1}, \dots, a_n \vee b_n)$. If the strings $Dec_1 = (a_1, a_2, \dots, a_i, a_{i+1} \vee b_{i+1}, \dots, a_n \vee b_n)$ and (a_1, a_2, \dots, a_n) are not equal (otherwise we are done), $(a_1, a_2, \dots, a_n) \prec Dec_1$ and there exists $j > i$, such that $a_j = 0$ and $a_j \vee b_j = 1$. In this case exchange strings $(a_1, a_2, \dots, a_i, a_{i+1} \vee b_{i+1}, \dots, a_n \vee b_n)$ and $(a_1, a_2, \dots, a_j, a_{j+1} \vee b_{j+1}, \dots, a_n \vee b_n)$ and call last Dec_2 . Again, in case if $Dec_2 \neq (a_1, a_2, \dots, a_n)$, keep decreasing the order by the suggested method until we get $Dec_s = (a_1, a_2, \dots, a_n)$ and then we are done - (a_1, a_2, \dots, a_n) is at its place.

Note that in order to bring (a_1, a_2, \dots, a_n) to its place, we did not touch strings with lower order, so they will stay at their correct places. Second, the number of steps (gates) required to bring any (a_1, a_2, \dots, a_n) to its correct place equals the sum of the “increase order” and “decrease order” steps done, which is not more than n . There are 2^n binary strings, so the method requires at most $n * 2^n$ steps. ■

Note that the constructive proof of this theorem also provides the following statement:
any reversible function can be realized in terms of cascades of the gates from set Q .

Since the functions are reversible, the suggested method can be used in both directions:

- forward: as it is described in the theorem;
- backwards: start with the output part of the truth table and, using the same method, bring it to the first part (where all the Binary n-tuples are ordered lexicographically). The resulting network in this case will realize the inverse permutation f^{-1} . But, in order to get a network for the function f , it is enough to run the obtained network for f^{-1} in reverse direction.

Example 7. We illustrate the proof of the theorem on a (3, 3) function f with the output vector (0, 1, 2, 4, 3, 5, 6, 7). This function was introduced by Miller and Perkowski, and is used in [49] as benchmark function. Later on, it was named the Miller gate. Here we use the backwards method.

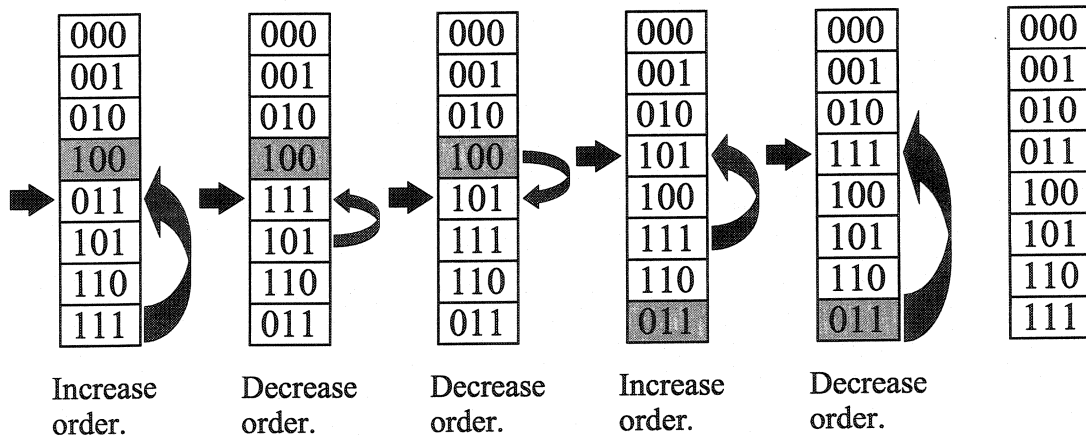

Figure 3.6: Building a network

- The first three outputs (0, 0, 0), (0, 0, 1), and (0, 1, 0) are at the correct place.

- Output $(1,0,0)$ (color it gray), which is not in its place, which is occupied by $(0,1,1)$ (where the left arrow shows). In order to bring $(1,0,0)$ to its place, run steps 1 and 2 from the algorithm.
 - Increase order: interchange $(0,1,1)$ with $(1,1,1)$ (shown by an arrow from left side).
 - Decrease order: interchange $(1,1,1)$ with $(1,0,1)$.
 - Decrease order: now we can bring $(1,0,0)$ to its place by changing it with $(1,0,1)$.

Note that in order to bring $(1,0,0)$ to its place we touched strings with the higher order only ($(0,1,1)$, $(1,1,1)$ and $(1,0,1)$).

- Take the next element, $(0,1,1)$. It is not in its place, so we color it gray, find its desired place and put an arrow from right pointing the target place.
 - Increase order: interchange $(1,0,1)$ with $(1,1,1)$ (shown by an arrow from left side).
 - Decrease order: interchange $(1,1,1)$ with $(0,1,1)$ to put the output string on its place.

Again, no lower order strings were used: $(0,1,1) \prec (1,0,1) \prec (1,1,1)$.

- Strings $(1,0,1)$, $(1,1,0)$ and $(1,1,1)$ are at their place, so the network is complete.

In this case the method gave an optimal network. However, we would not expect this in general, since this method only uses a small subset of the gates available and the used gates perform a “small” change (thus, such an “easy” transformation like NOT will be

realized by a large circuit). In addition, the theoretical method uses very wide gates, thus the quantum complexity of the resulting circuit is expected to be very high. To build a better circuits than the theoretical algorithm possibly can, we use a different synthesis approach.

3.3 Heuristic Synthesis

Let Q be the set of all possible gates with n inputs. We have shown that $|Q| = n3^{n-1}$. Given the model for function implementation, the problem of synthesis is to write a function in terms of a sequence of gates from the set Q .

We solve this problem using an incremental approach. That is, we repeatedly choose a gate that will bring us closer to the desired function. In order to do this we need to be able to measure how close two functions are, and we call this the distance between two functions. We then choose the gate that will decrease the distance between the realized function and the target function. We continue to do this until the distance is zero.

To give a formal definition of the distance, we need the following:

Definition 7. A **partial realization** of f is any function f' of the same set of variables.

Definition 8. The **distance** between a reversible function f and its partial realization f' is the Hamming distance between the output parts of their truth tables.

Definition 9. The **error** of the function f is its distance to the identity function.

Example 8. The reversible function $f(x_1, x_2, x_3) = (x_1 \oplus \bar{x}_2x_3, \bar{x}_2, x_1 \oplus x_2x_3)$ whose truth table is shown in Table 3.4 has 14 errors (shown in bold.)

x_1	x_2	x_3	f_1	f_2	f_3
0	0	0	0	1	0
0	0	1	1	1	0
0	1	0	0	0	0
0	1	1	0	0	1
1	0	0	1	1	1
1	0	1	0	1	1
1	1	0	1	0	1
1	1	1	1	0	0

Table 3.4: Truth table of $f(x_1, x_2, x_3) = (x_1 \oplus \bar{x}_2x_3, \bar{x}_2, x_1 \oplus x_2x_3)$

Example 9. A partial realization $f'(x_1, x_2, x_3) = (x_1 \oplus \bar{x}_2x_3, x_2, x_3)$ of the reversible function from the previous example is at distance 12 from the target function f (see Table 3.5.)

The previous two examples had an even number of error bits, and the number of error 1-bits was equal to the number of error 0-bits. This result holds in general as shown in the following lemma.

Lemma 3. The error of a reversible function is even. Among the error bits the number of those equal to one is the same as the number equal to zero.

Proof. To see that this is correct, we can write down the truth table of a reversible

f_1	f_2	f_3	f'_1	f'_2	f'_3
0	1	0	0	0	0
1	1	0	1	0	1
0	0	0	0	1	0
0	0	1	0	1	1
1	1	1	1	0	0
0	1	1	0	0	1
1	0	1	1	1	0
1	0	0	1	1	1

Table 3.5: Distance between f and its partial realization

function and consider a column in the output part. Suppose the error in this column occurs in k 0 bits and s 1 bits. Since the function is reversible, each column of the output part of the truth table contains 2^{n-1} zero bits and 2^{n-1} one bits. Therefore, the chosen column has $(2^{n-1} - k)$ zeros and $(2^{n-1} - s)$ ones. Now, if we flip all the error bits of the function, it is the n -bit identity function (which also is reversible). From the point of view of number of zeros and ones, this operation adds s zeros and k ones in the considered column. In the modified truth table, the numbers of zeros and ones become $(2^{n-1} - k + s)$ and $(2^{n-1} - s + k)$ respectively. Since the function is reversible, the number of zeros as well as the number of ones should remain 2^{n-1} , which gives the following set of equations:

$$2^{n-1} - s + k = 2^{n-1} - k + s = 2^{n-1}$$

for which the only solution is $k = s$. Therefore, the total number of errors in this column

is $2k$, an even number. The same proof can be given for each of n output columns, thus the total error is an even number. ■

Note that we actually proved a stronger statement, namely: the error is an even number in every output column. The other consequence we can derive is that the distance between a function and its partial implementation is always an even number. It is also not hard to see that the number of ones that are out of place is the same as the number of zeros that are out of place.

Consider the following simple idea for a synthesis method, which it will be used later as a basis for the heuristic synthesis algorithm we build: start with identity function, find a gate from the set Q such that when added to the partial realization f' will decrease the distance to f . Sometimes there is no gate that decreases the distance to f . But at any time, it is possible to choose a gate that at least does not increase the distance to f . For an illustration see Example 10.

Example 10. A reversible function with specification $(x, y) \rightarrow (\bar{y}, \bar{x})$ and the identity function, have this property: no gate will improve the distance function.

We use the word **step** to denote the addition of a gate to a cascade network. Therefore, the number of steps made is the number of gates in the network. A step is called **positive (negative)** if the distance increases (decreases).

Lemma 4. (existence of non-positive step) If the distance between f and f' is greater than zero (the partial realization f' is not the function f itself yet), there exists a gate in Q that transforms f' to f'' such that the distance between f and f'' is less

than or equal to the distance between f and f' .

Proof. Let $(a_1, a_2, \dots, a_{n-1}, X)$ be a string in the output part of the truth table of some partial realization with an error in bit X (which is assumed to be on the n -th place without loss of generality). Interchange it with the distance-1 string $(a_1, a_2, \dots, a_{n-1}, a_n)$, where $a_n = \bar{X}$. To do so use the gate made of line types $3 - a_1, 3 - a_2, \dots, 3 - a_{n-1}, 1$ correspondingly, where the Boolean numbers a_1, a_2, \dots, a_{n-1} are treated as natural numbers. It is easy to see that the gate with this specification exchanges the named strings and does nothing to all others. Errors in the first $(n-1)$ bits stay the same, but for the last bit the following table shows all the possible ways this interchange could happen (Table 3.6). So, we get a zero step or a negative step. ■

X value	a_n value	a_n was correct?	error was	error becomes	step is
0	1	Y	1	1	0
1	0	Y	1	1	0
0	1	N	2	0	-2
1	0	N	2	0	-2

Table 3.6: Effect of changing one bit

Here the question arises: is it possible to realize the function without positive steps? The answer is yes, and the design method is given in Theorem 3. The proof for this theorem is constructive and suggests a design procedure. The only thing that is left to prove is that the steps “Increase order” and “Decrease order” are non-positive. Indeed, the essence of each of these steps is to put a correct bit (0 for “Increase order” and 1 for

“Decrease order” steps) in its place. The Lemma above states that each of these steps are non-positive. This fact allows us to formulate the following result and use it as a core to create a synthesis algorithm.

Theorem 4. *There exists a synthesis method that adds a gate only if it performs a non-positive change to the distance function. Such a method converges for any reversible function.*

3.3.1 The Algorithm

The actual implementation of the algorithm works as follows:

1. Define the number *MaxMoves* (which in actual implementations was taken in the range of 50-500).
2. While the distance is greater than zero from among all Q gates, find the best *MaxMoves* steps. For each of them, find the best second step. After this step there are *MaxMoves* pairs of gates in the list. Search for the sequence of 2 gates that maximally improves (minimizes) the distance between the existing partial realization and the function itself. If such a pair is unique, attach the first gate to the cascade and go back to 2.
3. If two or more pairs of gates produce the same improvement to the distance, activate TieBreaker. TieBreaker is the function that finds the third best gate for each pair, and if one of the pairs has a better third gate (that minimizes the distance function), chooses this pair. Then, attach the first gate of the chosen pair to the cascade and go to 2.

4. If TieBreaker was not able to find a pair where the third step gives a better improvement, then take the pair that gives the best improvement for the first gate. Go to 2.
5. If the gate to be assigned is not chosen yet, take the first pair of the gates among those that give the best improvement (from the list produced at step 2). Go to 2.

Theorem 4 states that the distance will not be increased, because there is always a zero step available. In general such a method is not guaranteed to converge, although it does converge for every function we tried. We use this algorithm instead of the theoretical one that is guaranteed to converge, since the latter is likely to give a larger number of steps, because the distance can only decrease by at most two.

An (n, n) reversible function (f_1, f_2, \dots, f_n) in general can be realized by one of the $n!$ possible designs. This happens if we assume that the order of the output functions does not matter. We can enumerate the outputs in any order, and thusly realize different functions. In our case, for the larger functions (starting from $(7,7)$ functions and larger) we used a heuristic for the output permutation: we took the output permutation that gave the smallest error for the function or its complement. For the functions with a smaller number of variables, we are able to run all the possible permutations and choose the best result.

Example 11. Consider the function with specification $(x, y) \rightarrow (\bar{y}, \bar{x})$ from Example 10. Without the output permutation it will take us at least three gates to build a network for it: the first step is a zero step, as was shown in the previous example. Then, we have 2 errors in each of two output bits. This will require at least 2 more gates, since

each of them in the best case scenario can take care of at most one output bit at a time. So, the theoretical minimum is 3 gates (in fact, our algorithm terminates in 3 steps). A function $(x, y) \rightarrow (\bar{y}, \bar{x})$ with permuted outputs (that is, $(x, y) \rightarrow (\bar{x}, \bar{y})$) can be easily realized with two steps, namely a negation of first and second input bits.

3.3.2 Multiple Output Functions

Using the results of Theorem 1 we are able to add the minimal number of garbage bits in order to make a multiple output function reversible. The benefit in realization of a multiple output function is that we do not care about some of the outputs; the actual values of the garbage bits are of no interest. This allows us to:

1. Have a smaller error and therefore, in general, have less steps to make in order to create a network.
2. Have more freedom in changing “don’t care” outputs. There is no risk in adding an error to a “don’t care” output. We minimize the distance to the target outputs only.

3.3.3 Benchmarks

Due to the similarity of gates in the set Q and the generalized Toffoli gates, we introduce the following notation. The gate Q_{a_1, a_2, \dots, a_n} is denoted as $\text{TOF}(x_{i_1}^{\sigma_1}, x_{i_2}^{\sigma_2}, \dots, x_{i_{s-1}}^{\sigma_{s-1}}; y)$, which is constructed as follows:

- Write “TOF(”.
- For each a_i
 - if $a_i = 2$ write “ x_i ”;

- if $a_i = 3$ write “ \bar{x}_i ”;
- otherwise do nothing.

Separate different entities with commas.

- Write “; x_j ” at the very end, where j is defined such that $a_j = 1$. By the definition of Q gate such j will be unique. Finish with the closing bracket “)”

For example, gate $Q_{3,1,4,2,4}$ can also be written as $\text{TOF}(\bar{x}_1, x_4; x_2)$. This form of writing the gate is better for application use since it makes sense out of the structure of a gate. The old form was used for the simplicity of formulas in mathematical proofs.

In this section we compare our algorithm to the previous algorithms. Unfortunately, some authors do not give enough information to allow us to do so. For example, authors of [29] suggest an approach for reversible cascade synthesis of one output functions. They do not provide the experimental results, nor the algorithm, therefore we can not compare those results to ours. Shende *et al.* [74, 75] provide the optimal synthesis method for the (3, 3) reversible functions only. Work [60] is concentrated on reversible synthesis of symmetric functions, which is less general than our approach. Iwama *et al.* [22] base their method on circuit transforms, but they do not provide any experimental data.

We compare our results with those of three systematic methods: one by Miller [49], another by Mishchenko and Perkowski [54], and a third by Khan and Perkowski [28, 27].

Miller [49] suggests a reversible function synthesis that starts with a reversible specification only. He uses a spectral technique to find the best gate to be added in terms of

gates (NOT, CNOT, Toffoli3, and Toffoli4) and adds the gate in a cascade-like manner. This method has been modified in [50] to synthesize networks of the presented RCMG model. In his method the output function is required to appear as a set of actual outputs or their negations. Miller also used a postprocessing process to simplify the network (the results of simplification are given in brackets for the cases for which the process was done). The results from all examples in [49] compared to ours are summarized in Table 3.7, where **name** is the name of the benchmark function, **in/out** is the number of its inputs/outputs, **Miller** is the number of gates for Miller's method, and **We** is the number of gates for the proposed synthesis method.

name	in/out	Miller	We
ex1	3	3	3
ex2	3	5	5
ex3	4	7	7
ex4	3	4	3
ex5	4	5	4
ex6	4	12(10)	7
ex7	4	9(7)	7

Table 3.7: Comparison with Miller's results

Example 12. Since our method gives a better result for *ex4*, here follows our network for this function. *Ex4* is a (4,4) reversible function, given as the truth vector [3, 11, 2, 10, 0, 7, 1, 6, 15, 8, 14, 9, 13, 5, 12, 4] whose binary representation gives the actual Boolean values. Using the output permutation (2, 1, 3, 4), the scheme consists of

the following seven gates: $\text{TOF}(b)$ $\text{TOF}(\bar{c}, d; a)$ $\text{TOF}(a, d; c)$ $\text{TOF}(a, \bar{c}; d)$ $\text{TOF}(\bar{c}, \bar{d}; a)$ $\text{TOF}(\bar{a}, \bar{d}; c)$ $\text{TOF}(\bar{a}, \bar{c}; b)$ for the names of variables a, b, c and d . In comparison, Miller's synthesized network is: $\text{TOF}(d)$ $\text{TOF}(b)$ $\text{TOF}(b, c; d)$ $\text{TOF}(b)$ $\text{TOF}(a, c; d)$ $\text{TOF}(c)$ $\text{TOF}(a, b; d)$ $\text{TOF}(a; c)$ $\text{TOF}(b, c; a)$ $\text{TOF}(b; c)$ $\text{TOF}(a; c)$ $\text{TOF}(a; b)$. This network was transformed to the following: $\text{TOF}(d)$ $\text{TOF}(b)$ $\text{TOF}(b, c; d)$ $\text{TOF}(b)$ $\text{TOF}(a, c; d)$ $\text{TOF}(c)$ $\text{TOF}(a, b; d)$ $\text{FRE}(b, c; a)$ $\text{TOF}(b; c)$ $\text{TOF}(a; b)$, where $\text{FRE}(b, c; a)$ is the Fredkin gate.

Mishchenko and Perkowski [54] suggest a reversible wave cascade method and evaluate the complexity of some benchmark functions in terms of the number of these cascades. They do not provide the actual design for the described method, but instead they give upper bounds. We compare their results to ours and summarize the comparison in Table 3.8. Although our results are not always better than those of Mishchenko and Perkowski in terms of the total complexity, the important factor, the number of garbage bits, is definitely improved using our approach. We were not able to compare the results for functions with a larger number of inputs/outputs due to the huge amount of work our algorithm needs to find a network representing such a function. In this table, the first

Function			Garbage		Cost	
name	in	out	Mishchenko, Perkowski	We	Mishchenko, Perkowski	We
5xp1	7	10	38	0	31	43
9sym	9	1	56	9	52	60
rd53	5	3	19	4	14	13
rd73	7	3	43	6	36	36

Table 3.8: Comparison with Perkowski's results

three columns describe the function: the name, number of input bits, and number of output bits of a benchmark function. First pair of columns **Mishchenko-Perkowski** and **We** lists the number of garbage outputs from the result of Mishchenko and Perkowski's method and our method; the remaining pair of columns compares the numbers of gates in designs of the benchmark functions for Mishchenko and Perkowski's method and our proposed design respectively. Our method does not always find the realization with the minimum number of gates, but if we consider the cost of a benchmark function to be the sum of the number of gates and the garbage, then our method gives a better result.

Results shown by Khan [28, 27] are weaker (although newer) than the results in [54], but for the sake of completeness, we show the comparison in the table below. Note that our results are better in all cases except for the *9sym* function. However, this is a weakness of the synthesis method we have, not the model, since every single output non-balanced function can be realized with the cost of the number of terms in its minimal EXOR polynomial as is shown in Section 3.4 of this chapter.

Function			Garbage		Cost	
name	in	out	Khan	We	Khan	We
5xp1	7	10	63	0	56	49
9sym	9	1	60	9	52	56
rd53	5	3	19	4	17	13
rd73	7	3	47	6	43	36

Table 3.9: Comparison with Khan's results

It is also interesting to notice that the benchmark *rd53* can be realized in terms of an ESOP with 14 terms as the result of Perkowski and Mishchenko states. For our method this number is 13, which shows that the proposed method can do better than EXOR minimization can. The following example contains one more function for which our method is more efficient, compared to the standard non-reversible technological realization of ESOP, the EXOR PLA.

Example 13. The (5,1)-function *2of5* whose output is 1 if and only if exactly two of the input variables are 1 in terms of ESOP can be realized with 8 terms. Our synthesis method is capable of creating a network (for the proposed structure) with 7 gates only. The function *2of5* is not balanced, therefore the minimal garbage for it is 5. Thus, the (5,1)-function becomes a (6,6) reversible function. We used the last output to realize the function, and named the inputs as a, b, c, d, e , and f , where the last input is a constant 0. The network structure is as follows: $\text{TOF}(a, \bar{d}, e, \bar{f}; c)$ $\text{TOF}(\bar{b}, c, \bar{d}; f)$ $\text{TOF}(\bar{a}, c, \bar{e}; f)$ $\text{TOF}(\bar{a}, b, d, \bar{e}; f)$ $\text{TOF}(\bar{a}, \bar{f}; e)$ $\text{TOF}(\bar{b}, \bar{c}, d, \bar{e}; f)$ $\text{TOF}(b, \bar{c}, \bar{d}, \bar{e}; f)$.

Some of the actual circuit designs that we discussed in this chapter can be viewed at [http : //www.cs.unb.ca/profs/gdueck/quantum/](http://www.cs.unb.ca/profs/gdueck/quantum/) [44]. It also happens that the synthesis in RCMG model is beneficial to the synthesis of ESOPs, which is shown in the following section.

3.4 RCMG and ESOP Comparison

To exploit the similarity between the two chosen models, note that each of the terms in the ESOP can be treated as a separate gate. All the terms are arranged in the form of a cascade, namely a string that is the EXOR of terms which builds the ESOP polynomial.

The following summarizes the similarities and differences between the two models.

- Both models use the same operations, namely, AND, EXOR, and negation.
- The gates are similar. Each gate acts as an EXOR of the term built from the input variables. The difference is that in ESOP the set of input variables is not changing while passing through the gates, where for RCMG this is not true.
- The number of distinct gates is comparable: $n * 3^{n-1}$ for RCMG and 3^n for the ESOP.
- The gates are in a linear order. The terms being “exored” form a string, and generalized Toffoli gates form a cascade. The difference between them is in whether the order matters. The order of terms in a polynomial does not matter, whereas the order of reversible gates in our model does.

Lemma 5. By adding a constant input it is possible to use the results of an ESOP minimization to build a reversible network for a single output Boolean function.

Proof. Take an n -input Boolean function and create a zero constant on the input line x_{n+1} . This may result in non-optimality of the garbage. Transform each term $x_{i_1}^{\sigma_1} x_{i_2}^{\sigma_2} \dots x_{i_k}^{\sigma_k}$ to the gate $TOF(x_{i_1}^{\sigma_1}, x_{i_2}^{\sigma_2}, \dots, x_{i_k}^{\sigma_k}; x_{n+1})$. Such a transformation of each of the terms in the ESOP results in the set of gates of the RCMG; when arranged in a cascade, they form a reversible network for the function. ■

The more interesting question is if the RCMG model is sufficiently efficient in comparison to the ESOP. The answer for this question is “yes”, and the following set of Boolean functions grows polynomially for the RCMG and exponentially for the ESOP.

Definition 10. For every even integer n , a Boolean function $exphard_n(x_1, x_2, \dots, x_n)$ is defined as $(x_1 \oplus x_2)(x_3 \oplus x_4) \dots (x_{n-1} \oplus x_n)$.

Lemma 6. Function $exphard_n$ can be realized with cost $1 + \frac{n}{2}$ in terms of the RCMG model.

Proof. The cascade of gates $TOF(x_1; x_2) \ TOF(x_3; x_4) \ \dots \ TOF(x_{n-1}; x_n) \ TOF(x_2, x_4, \dots, x_{n-1}; x_n)$ defines the structure of the network (Figure 3.7A). ■

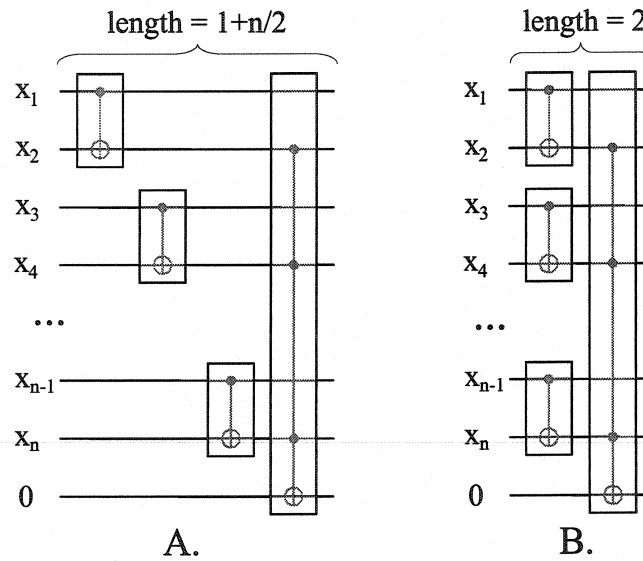

Figure 3.7: Reversible design structure.

Note that in the actual implementation the first $n/2$ gates $TOF(x_1; x_2), TOF(x_3; x_4), \dots, TOF(x_{n-1}; x_n)$ form a single layer. The remaining gate, $TOF(x_2, x_4, \dots, x_n)$ forms the second layer. Thus, the total length of the network becomes a constant, namely 2 (Figure 3.7B).

To show that no ESOP shorter than an ESOP with exponential length can represent function $exphard_n$, we need the following Lemmas:

Lemma 7. Every term in an optimal ESOP for $g(x_1, x_2, \dots, x_n, y) = yf(x_1, x_2, \dots, x_n)$, where $y \notin \{x_1, x_2, \dots, x_n\}$, contains variable y and contains it without negation.

Proof. Let M be an optimal ESOP for the function $g(x_1, x_2, \dots, x_n, y)$. Write it as

$$M = yM'_1 \oplus M'_2 \oplus \bar{y}M'_3 = y(M'_1 \oplus M'_3) \oplus (M'_2 \oplus M'_3), \quad (3.1)$$

where M'_1, M'_2 and M'_3 do not contain y . The total cost of this ESOP is the sum of the number of terms in M'_1, M'_2 and M'_3 , which is $|M'_1| + |M'_2| + |M'_3|$. Let N be an ESOP for f . Then yN forms an ESOP for yf . Add yN and M :

$$0 = yf \oplus yf = yN \oplus M = y(M'_1 \oplus M'_3 \oplus N) \oplus (M'_2 \oplus M'_3).$$

If we write it by components, we have:

$$M'_1 \oplus M'_3 \oplus N = 0, M'_2 \oplus M'_3 = 0. \quad (3.2)$$

Use this last equality to continue from equation (3.1):

$$\begin{aligned} yf = M &= y(M'_1 \oplus M'_3) \oplus (M'_2 \oplus M'_3) \\ &= y(M'_1 \oplus M'_3) \oplus 0 \\ &= y(M'_1 \oplus M'_3) \\ &= yM'_1 \oplus yM'_3. \end{aligned}$$

This ESOP has $|M'_1| + |M'_3|$ terms. Since M is minimal, the number of terms of M'_2 is zero. Therefore, the number of terms of M'_3 is also zero, which can be seen from the second equation in (3.2). In other words, $M = yM'_1$. ■

Lemma 8. Any optimal ESOP for $g(x_1, x_2, \dots, x_n, y) = yf(x_1, x_2, \dots, x_n)$, where $y \notin \{x_1, x_2, \dots, x_n\}$, has the same complexity as an optimal ESOP for $f(x_1, x_2, \dots, x_n)$.

Proof. Lemma 7 enables us to factor variable y out of an optimal ESOP M for the function $g(x_1, x_2, \dots, x_n, y)$: $M = yM'$, where M' is an ESOP that does not contain y in any form. Let $y = 1$. Then, $M' = (yM')|_{y=1} = M|_{y=1} = (yf(x_1, x_2, \dots, x_n))|_{y=1} = f(x_1, x_2, \dots, x_n)$. In other words, M' has the complexity of a minimal ESOP for $f(x_1, x_2, \dots, x_n)$, so the ESOP M does also. ■

Lemma 9. A minimal ESOP for the function $g(x_1, x_2, \dots, x_n, y, z) = yf(x_1, x_2, \dots, x_n) \oplus zf(x_1, x_2, \dots, x_n)$, where y, z are variables and $y, z \notin \{x_1, x_2, \dots, x_n\}$, consists of at least $\frac{3|f|}{2}$ terms, where $|f|$ is the number of terms in a minimal ESOP for f .

Proof. We can take a minimal ESOP M of the function $g(x_1, x_2, \dots, x_n, y, z)$ and write it as $M = yM_1 \oplus M_2 \oplus \bar{y}M_3$, where M_1, M_2 and M_3 are ESOPs that do not contain the variable y in either term. Such a decomposition is unique. Notice that the sets of terms in each of M_1, M_2 and M_3 do not intersect:

- $M_1 \cap M_2 = \emptyset$;
- $M_1 \cap M_3 = \emptyset$;
- $M_2 \cap M_3 = \emptyset$.

Otherwise, suppose that $M_1 \cap M_2 \neq \emptyset$. Then, there exists a term $t \in (M_1 \cap M_2)$. Since $yt \oplus t = \bar{y}t$, by deleting these two terms from ESOPs M_1 and M_2 and adding it to M_3 we get an ESOP that has complexity (that is, the number of terms in an ESOP)

one less than the optimal ESOP M . This contradicts the optimality of M . Therefore, $M_1 \cap M_2 = \emptyset$. The other two set intersections can be proven to be empty similarly.

Let $y = 0$ in the ESOP $M = yM_1 \oplus M_2 \oplus \bar{y}M_3$ for the function $yf \oplus zf$. This results in

$$(yf \oplus zf)|_{y=0} = (yM_1 \oplus M_2 \oplus \bar{y}M_3)|_{y=0}$$

and

$$zf = M_2 \oplus M_3. \quad (3.3)$$

Similarly, assigning $y = 1$ leads to

$$\bar{z}f = M_1 \oplus M_2. \quad (3.4)$$

Adding (3.3) and (3.4) produces

$$f = M_1 \oplus M_3. \quad (3.5)$$

By Lemma 8, we conclude that each of the ESOPs in (3.3) and (3.4) has at least $|f|$ terms. So does the ESOP from (3.5).

As we proved before, the sets of terms in M_1 , M_2 and M_3 do not intersect, so based on Lemma 8, (3.3), (3.4), and (3.5), the following system can be written:

$$\begin{cases} |M_2 \oplus M_3| = |M_2| + |M_3| \geq |f| \\ |M_1 \oplus M_2| = |M_1| + |M_2| \geq |f| \\ |M_1 \oplus M_3| = |M_1| + |M_3| \geq |f| \end{cases}$$

Since

$$|M| = |yM_1 \oplus M_2 \oplus \bar{y}M_3| = |M_1| + |M_2| + |M_3|,$$

the problem of finding the number of terms in a minimal ESOP for $(yf \oplus zf)$ is bounded by the solution of the following linear optimization problem: minimize $(|M_1| + |M_2| + |M_3|)$ subject to

$$\begin{cases} |M_2| + |M_3| \geq |f| \\ |M_1| + |M_2| \geq |f| \\ |M_1| + |M_3| \geq |f| \end{cases}$$

which is given by the expression $\frac{3|f|}{2}$. ■

The proof of the following statement allows us to derive the exact number of terms in a minimal ESOP for $exphard_n$.

Conjecture. The minimal ESOP for the function $g(x_1, x_2, \dots, x_n, y, z) = yf(x_1, x_2, \dots, x_n) \oplus zf(x_1, x_2, \dots, x_n)$, where y, z are variables and $y, z \notin \{x_1, x_2, \dots, x_n\}$, consists of $2|f|$ terms.

Theorem 5. A minimal ESOP for the function $exphard_n$ has at least $(\frac{3}{2})^{\frac{n}{2}}$ terms.

Proof. This result is easily proven by induction using Lemma 9. ■

A better lower bound can be achieved for the best ESOP complexity of the $exphard_n$ function by saying that every time we apply Lemma 9, the actual ESOP lower bound is $\left\lceil \frac{3|f|}{2} \right\rceil$ (as a natural number, greater than $\frac{3|f|}{2}$), which brings a larger bound into the next step. The final formula for this observation will look like:

$$|M| \geq \left[\left[\left[\frac{3}{2} \right] * \frac{3}{2} \right] * \dots * \frac{3}{2} \right] \quad (3.6)$$

Table 3.10 summarizes the results for the function $exphard_n$. The first column, n , shows the number of inputs. The second column is the number of gates needed for the model

RCMG to realize the function. The third column shows the cost for the application of the RCMG model. We used the Exorcism-4 [78, 53] program to calculate the near minimal ESOP for the $exphard_n$ function. The results of this program are summarized in the fourth column. Note, that this column supports the conjecture. The fifth column shows the theoretically proven lower bound on the minimal ESOP, given by formula (3.6).

n	RCMG	NRA RCMG	Exorcism-4	ESOP min
2	2	2	2	2
4	3	2	4	3
6	4	2	8	5
8	5	2	16	8
10	6	2	32	12
12	7	2	64	18
14	8	2	128	27
16	9	2	256	41
18	10	2	512	62
20	11	2	1024	93
22	12	2	2048	140
24	13	2	4096	210

Table 3.10: Complexity of the function $exphard_n$.

3.4.1 Multiple Output Functions

One of the reasons that ESOPs are used is their ability to share terms. The RCMG model does not have this property. However, the RCMG model can be united with the mEXOR model introduced in Chapter 6 to form a new hybrid model. This will allow the use of multiple EXOR output Toffoli gates with the same control, which is equivalent to term sharing in the non-reversible ESOP model. It can be shown by examining the gate that the quantum realization of such a hybrid gate has a cost that differs from the cost of the original Toffoli gate only marginally, e.g. around 10%. The result of Lemma 5 will now hold for any multiple output Boolean function.

3.5 Conclusions

In this chapter we introduced the synthesis model and the synthesis procedure which allows us to minimize the most important factor of the reversible circuit cost (for instance, for quantum NMR technology) — its garbage. We showed that the new gates differ from the generalized Toffoli gates only marginally. We synthesized the benchmark functions and achieved good results in comparison to the previously shown results: in some cases our method requires less gates, and in all cases our garbage is theoretically minimal. Finally, the synthesis in the RCMG model was shown to be better in comparison to the synthesis of conventional ESOPs in the sense that no RCMG representation of a function requires more gates than the number of terms in a minimal ESOP. On the other hand, there exists a class of polynomial complexity functions in terms of RCMG which can be realized as an ESOP with exponential cost only.

Chapter 4

Toffoli Synthesis

The RCMG model from the previous section has used complex gates, which essentially consist of three logical parts: NOT gate preprocessing, a generalized Toffoli gate, and NOT gate postprocessing. One of the unavoidable problems of this theoretical algorithm discussed in the previous chapter, and a reason to create a different heuristic procedure, is the number and size of the gates needed for the computation. Clearly, it is better to have fewer gates of a smaller size. In this chapter this problem is solved by considering Toffoli gates and an updated synthesis procedure, which tries to use narrow (with less controls) gates. This new synthesis algorithm keeps the key idea presented in the previous section; initially the cascade is built from the outputs to the inputs, by bringing patterns to their places without changing patterns which are already at their place. Furthermore, a generalized version of this algorithm, a bidirectional modification, is developed. When the algorithm terminates and an initial circuit is created, local transformations, called template simplification tools, are applied. In this chapter we do not concentrate on results, since in Chapter 5, the algorithm and template tools are generalized to handle Toffoli and Fredkin gates, so the results of this chapter will be covered by newer results in Chapter 5. Toffoli templates are of interest as they are easier to analyze, and develop our intuition for a more generalized set of templates.

4.1 The Algorithm

Applying a Toffoli gate to the inputs or outputs of a reversible function always yields a reversible function. The synthesis problem is to find a sequence of Toffoli gates which transforms a given reversible function to the identity function. As gates can be applied either to the inputs or outputs, the synthesis can proceed from outputs to inputs, from inputs to outputs or, as we show in Subsection 4.1.2, in both directions simultaneously.

4.1.1 Basic Algorithm

To begin, we present a basic naive and greedy algorithm which identifies Toffoli gates only on the output side of the specification.

Consider a reversible function specified as a mapping over $\{0, 1, \dots, 2^n - 1\}$; in other words, a truth vector.

Basic Algorithm

Step 0: If $f(0) \neq 0$, invert the outputs corresponding to 1-bits in $f(0)$. Each inversion requires a NOT gate. The transformed function f^+ has $f^+(0) = 0$.

Step i: Consider each i in turn for $1 \leq i < 2^n - 1$ letting f^+ denote the current reversible specification. If $f^+(i) = i$, no transformation and hence no Toffoli gate is required for this i . Otherwise, gates are required to transform the specification to a new specification with $f^{++}(i) = i$. The required gates must map $f^+(i) \rightarrow i$.

Let p be the bit string with 1s in all positions where the binary expansion of i is 1 while the expansion of $f^+(i)$ is 0. These are the 1 bits that must be added in transforming

$f^+(i) \rightarrow i$. Conversely, let q be the bit string with 1s in all positions where the expansion of i is 0 while the expansion of $f^+(i)$ is 1. q identifies the bits to be removed in the transformation.

For each $p_j = 1$, apply the Toffoli gate with control lines corresponding to all outputs in positions where the expansion of i is 1 and whose target line is the output in position j . Then, for each $q_k = 1$, apply the Toffoli gate with control lines corresponding to all outputs in positions where the expansion of $f^+(i)$ is 1 and whose target line is the output in position k .

For each $1 \leq i < 2^n - 1$, Step 2 transforms $f^+(i) \rightarrow i$ by applying the specified sequence of Toffoli gates. Since we consider the i values in order, and step 1 handles the case for 0, we know that $f^+(j) = j, 0 \leq j < i$. The importance of this is that it shows that none of the Toffoli gates generated in Step 2 affect $f^+(j), j < i$. In other words, once a row of the specification is transformed to the correct value, it will remain at that value regardless of the transforms required for later rows. Clearly, the final row of the specification never requires a transformation as it is correct by virtue of the correct placement of the preceding $2^n - 1$ values.

Table 4.1 illustrates the application of the basic algorithm. (i) is the given specification. Step 1 identifies the application of $TOF(a^0)$ giving (ii). At this point $f^+(i), 0 \leq i \leq 4$ are as required. Mapping $f^+(5) \rightarrow 5$ requires $TOF(c^1, b^1; a^1)$ to change the rightmost bit to 1 (iii) and $TOF(c^2, a^2; b^2)$ to remove the center 1 (iv). Lastly, $TOF(c^3, b^3; a^3)$ is again required, this time to map $f^+(6) \rightarrow 6$. Note that the gates are identified in order from the output side to the input side. The corresponding circuit is shown in Figure

	(i)	(ii)	(iii)	(iv)	(v)
cba	$c^0b^0a^0$	$c^1b^1a^1$	$c^2b^2a^2$	$c^3b^3a^3$	$c^4b^4a^4$
000	001	000	000	000	000
001	000	001	001	001	001
010	011	010	010	010	010
011	010	011	011	011	011
100	101	100	100	100	100
101	111	110	111	101	101
110	100	101	101	111	110
111	110	111	110	110	111

Table 4.1: Example of applying the basic algorithm.

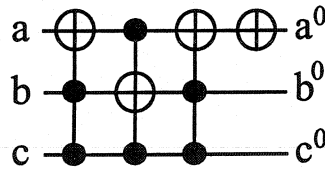

Figure 4.1: Circuit for the function shown in Table 4.1.

4.1.

The basic algorithm is straightforward and easily implemented. It is also easily seen that it will always terminate successfully with a circuit for the given specification.

Theorem 6. *The above algorithm successfully terminates with a circuit of size less than or equal to $(n - 1)2^n + 1$.*

Proof. Note that each gate application brings at least one bit to its correct place,

therefore the algorithm will definitely terminate after $n2^n$ steps. In order to prove a lower bound, we build the worst case scenario for this algorithm. The first output pattern will require the maximum number of gates (n) to bring it to the form of the first input pattern, 0, if it is its bitwise negation, $(2^n - 1)$. When the n corresponding gates of the algorithm are applied, assign the second output pattern so that it becomes the bitwise negation of the second input pattern 1, which is $(2^n - 2)$. At the second step of the algorithm n gates are needed again. Keep specifying the output pattern as the negation of the input for each step, which can be done until step $(2^{n-1} - 1)$ of the algorithm is completed. At this point, the first 2^{n-1} input patterns match the input, so the first bit of the whole structure was already brought to its place (when 2^{n-1} zeros are in the upper part, the remaining 2^{n-1} should be in the lower part). Therefore, starting from this step, the first bit is completely specified, and we cannot negate it to create a desired hard pattern. Starting from this step, negate only the remaining $(n-1)$ unspecified bits of the output. Similarly, at the step $2^{n-1} + 2^{n-2}$ of the algorithm the second bit will be completely specified. In general, at step $2^{n-1} + 2^{n-2} + \dots + 2^{n-k}$, the first k bits are completely specified. Thus, the maximum number of steps for the algorithm becomes

$$\begin{aligned}
 & n2^{n-1} + (n-1)2^{n-2} + (n-2)2^{n-3} + \dots + 2 * 2^{n-n+1} + 1 * 2^{n-n} = \\
 & = nx^{n-1} + (n-1)x^{n-2} + (n-2)x^{n-3} + \dots + 2 * x^1 + 1 * x^0|_{x=2} \\
 & = (x^n + x^{n-1} + x^{n-2} + \dots + x^2 + x + 1)'|_{x=2} \\
 & = \left(\frac{x^{n+1}-1}{x-1} \right)'|_{x=2}
 \end{aligned}$$

$$\begin{aligned}
 &= \left(\frac{(n+1)x^n(x-1) - x^{n+1} + 1}{(x-1)^2} \right) \Big|_{x=2} \\
 &= \left(\frac{(n+1)2^n(2-1) - 2^{n+1} + 1}{(2-1)^2} \right) \\
 &= (n+1)2^n - 2^{n+1} + 1 = (n-1)2^n + 1.
 \end{aligned}$$

■

Using the procedure from Theorem 6, it is possible to construct a (unique) function for any n that requires $(n-1)2^n + 1$ gates. Therefore, the upper bound is tight. For $n = 3$, this function has the truth vector $[7, 1, 4, 3, 0, 2, 6, 5]$ and will be further referred as 3.17. Using Theorem 6, it can be calculated that its cost is $(3-1)2^3 + 1 = 2 * 8 + 1 = 17$, which explains the given name: 3 represents the size and 17 represents the algorithm cost. Analogously, 4.49 is a size 4 hard function, whose truth vector is $[15, 1, 12, 3, 5, 6, 8, 7, 0, 10, 13, 9, 2, 4, 14, 11]$. Functions with a larger number of variables can be built. We will simplify the networks further and consider these functions to measure how good the simplification is.

We next consider a bidirectional algorithm, which usually produces smaller circuits.

4.1.2 Bidirectional Algorithm

As described so far, the algorithm produces the circuit by selecting the Toffoli gates that manipulate only the output side of the specification. Since the specification is reversible, one could consider the inverse specification, derive a reverse circuit, and then choose whichever is smaller. A better approach is to apply the method in both directions simultaneously choosing to add gates at the input side or the output side.

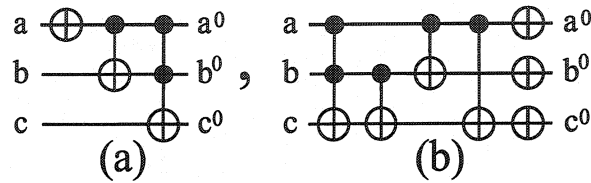

Figure 4.2: Circuits for the function shown in Table 4.2

To see how this works, consider the initial reversible specification in Table 4.2, column (i). The basic algorithm would require that we invert each of a^0 , b^0 and c^0 to make $f^+(0) = 0$. The alternative is to invert a , *i.e.* to apply the gate $TOF(a)$ to the input side. Applying this gate, and then reordering the specification so that the input side is again in standard truth-table order yields the specification in (ii). From the output side, we would next have to map $f^+(1) = 7 \rightarrow 1$. However, from the input side we can accomplish what is required by interchanging rows 1 and 3, which is done by applying the gate $TOF(a; b)$. Doing so, and reordering the input side into standard order, yields the specification in (iii). At this point, selection from the output side and the input side identify the same gate $TOF(a, b; c)$ (when expressed in terms of the input lines) and the circuit is done (iv). The result uses three gates (shown in Figure 4.2(a)), whereas approaching the problem from the output side alone requires three NOT gates just to handle $f(0)$ and seven gates in total (shown in Figure 4.2(b)).

In general, when $f^+(i) \neq i$, the choice is (a) to apply Toffoli gates to the outputs to map $f^+(i) \rightarrow i$, or (b) to apply Toffoli gates to the inputs to map $j \rightarrow i$ where j is such that $f^+(j) = i$. Since we consider the i in order, there must always be a j such that $j > i$. Also, the same rules for identifying the control lines, including the reduction described above apply. Let the bidirectional algorithm choose (a) if $H(i, f^+(i)) \leq H(i, j)$, and

	(i)	(ii)	(iii)	(iv)
cba	$c^0b^0a^0$	$c^1b^1a^1$	$c^2b^2a^2$	$c^3b^3a^3$
000	111	000	000	000
001	000	111	001	001
010	001	010	010	010
011	010	001	111	011
100	011	100	100	100
101	100	011	101	101
110	101	110	110	110
111	110	101	011	111

Table 4.2: Example of applying the bidirectional algorithm.

(b) otherwise (where $H(\bullet, \bullet)$ is the Hamming distance). We thus base the choice on the number of gates required and not their width or how closely they map the specification to the identity.

4.2 Templates

Idea of local transformations as a tool of reversible network simplification is not new. It is important to notice that application local transformations does not guarantee finding an optimal result, since the optimization procedures usually stuck in a local minimum. No good practical results on how far up one should go to be able to bring a circuit to its optimal form are known. However, local transformations stay a useful simplification procedure both in conventional (for example, [7, 78]) and reversible case

[22, 74, 42, 51, 75, 43, 41].

Several authors considered reversible network transformations. Shende *et. al* [74, 75] used several 4-bit circuit equivalences to be able to rewrite gates in a different order. Iwama, Kambayashi, and Yamashita [22] introduced some circuit transformation rules, which mainly served to bring a network to a canonical form and thus, stating that the set of transforms is complete. One of the transforms in [22] was proposed for circuit simplification, but the actual application procedure was not described.

In [51], templates were introduced as a tool for network simplification. In that work, a template consists of two sequences of gates which realize the same function. The first sequence of gates is to be matched to a part of the circuit being simplified and the second sequence is to be substituted when a match is found. The templates in Figure 4.3 were identified and classified based on their similarity: the first number in the figure shows which class the given template belongs to, the second identifies ordinal number of the template in its class.

In [51], the template matching procedure looks for the first set of gates, including the initial match to the widest gate, across the entire circuit. If all target gates are found, it attempts to make them adjacent using the moving rule: gate $TOF(C_1, t_1)$ can be interchanged with gate $TOF(C_2, t_2)$ if, and only if, $C_1 \cap t_2 = \emptyset$ and $C_2 \cap t_1 = \emptyset$. Adjacent gates can match the template in the forward or reverse direction. The matched gates are replaced with the new gates specified by the template. For a reverse match, the new gates are substituted in reverse order. Finally, if at any time two adjacent gates are equal, they can be deleted, (**deletion rule**).

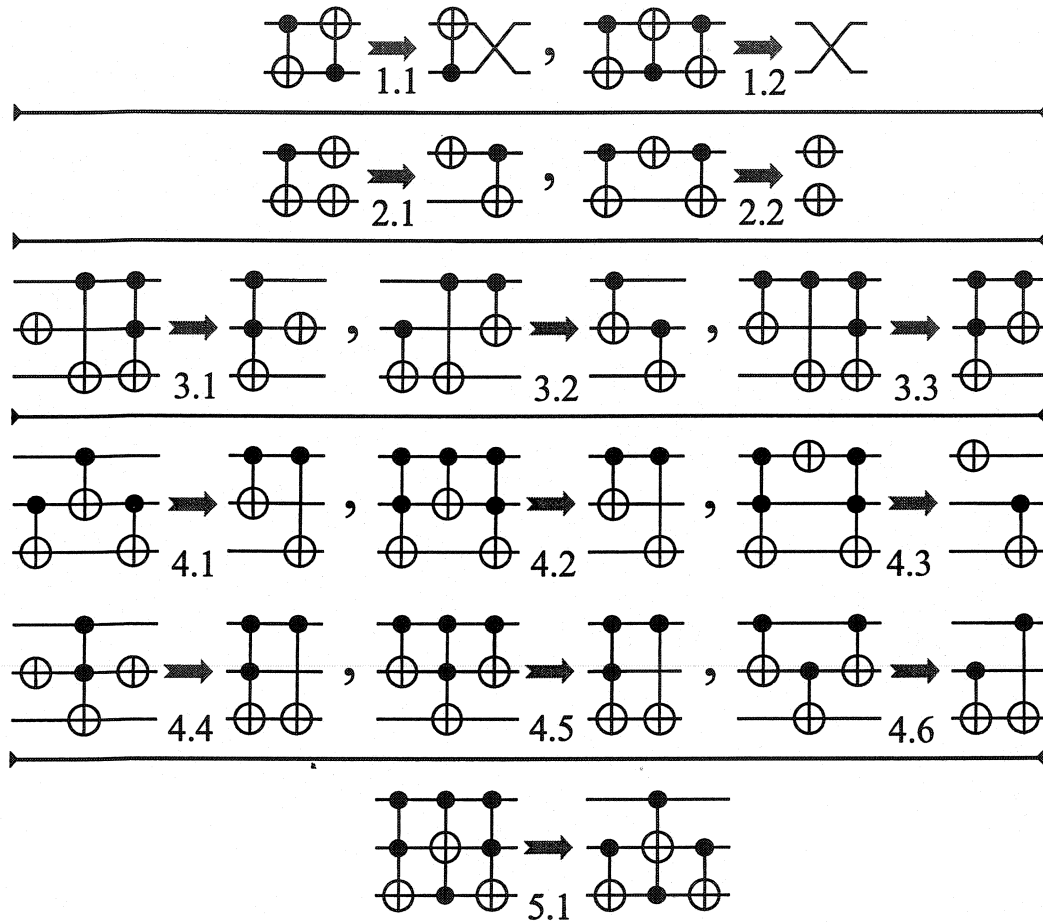

Figure 4.3: Templates with 2 or 3 inputs.

In this section, we give a formal classification of the templates used in [51]. However, for a better understanding of template classes, we introduce the following notation.

- the left hand side has a sequence of gates that is to be replaced with the sequence given on the right hand side;
- the controls of the gates are coded by sets C_i , each of which represents a set (which may be empty) of lines;
- the target sets t_i each contain a single line.

All sets are disjoint: $C_i \cap C_j = \emptyset, C_i \cap t_k = \emptyset, t_i \cap t_k = \emptyset \forall i, j, k, l$.

Using this notation, a class of templates can be defined as a set of templates which can be described by one formula. A first attempt to classify the templates results in the classes listed below:

Class 1. This class unites and generalizes the templates 2.2, 4.1-4.3 (Figure 4.3) into a class (Figure 4.4) with the formula:

$$\begin{aligned} & TOF(C_1 + C_2 + t_2, t_1) TOF(C_1 + C_3, t_2) TOF(C_1 + C_2 + t_2, t_1) \\ & = TOF(C_1 + C_3, t_2) TOF(C_1 + C_2 + C_3, t_1) \end{aligned} \quad (4.1)$$

Class 2. This class consists of templates 4.4-4.6 (Figure 4.3) and their generalizations.

The class is illustrated in Figure 4.4 and can be written as the following formula:

$$\begin{aligned} & TOF(C_1 + C_2, t_2) TOF(C_1 + C_3 + t_2, t_1) TOF(C_1 + C_2, t_2) \\ & = TOF(C_1 + C_3 + t_2, t_1) TOF(C_1 + C_2 + C_3, t_1) \end{aligned} \quad (4.2)$$

Class 3. This class (Figure 4.4) includes templates 2.1, 3.1-3.3 (Figure 4.3) and can be described by the formula:

$$\begin{aligned} & TOF(C_1 + C_2 + t_2, t_1) TOF(C_1 + C_2 + C_3, t_1) TOF(C_1 + C_3, t_2) \\ & = TOF(C_1 + C_3, t_2) TOF(C_1 + C_2 + t_2, t_1) \end{aligned} \quad (4.3)$$

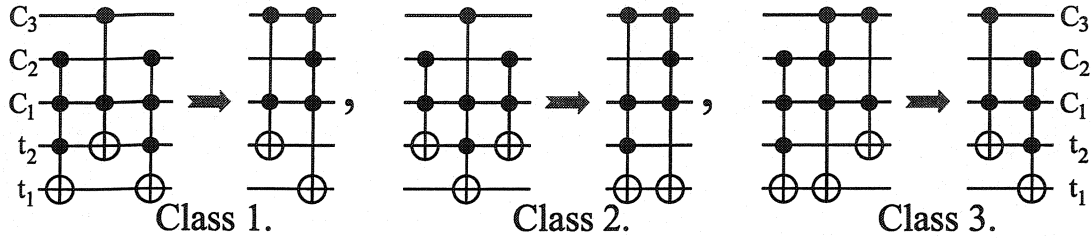

Figure 4.4: Toffoli templates.

Template 5.1 can be generalized, but this generalization is not considered here since template 5.1 does not decrease the number of gates in a network. However, the use of a generalization of this template may be beneficial since it introduces smaller gates that can be used by other templates. Even if they are not used, it is beneficial to have gates with fewer controls, since for some technologies their costs are lower. For instance, in quantum technology the cost of a Toffoli gate is 5 times higher than that of a CNOT gate. As the number of controls of the Toffoli gate grows, the relation between the costs of generalized Toffoli and CNOT gates grows quadratically if no additional garbage is allowed and linearly if additional garbage is allowed [4].

The correctness of formulas (4.1)-(4.3) is easily proven. A more interesting question is whether the set of these three classes of templates together with the two rules (moving rule, deletion rule) is a complete set of simplification rules for a sequence of three generalized Toffoli gates over n lines. To check this, we wrote and ran a program which

exhaustively searches all sequences of three gates built on four lines to check whether the sequence can be reduced by means of templates from the three classes and the two rules. This program found no new templates. Thus, we conclude that the three classes together with moving and deletion rules form the complete simplification tool for any Toffoli network with up to three gates.

4.2.1 Unification of Class 1 and Class 2 Templates

Classes 1 and 2, as illustrated in Fig. 4.4, look similar. This similarity results in the following description of the two classes as a single class:

- the first part of the template has 3 gates of the form ABA, *i.e.* the first and the third gates are the same;
- if the following algorithm produces a valid network, the template exists, otherwise it does not (correctness can be easily proven):
 - Take the second gate and put it first in the second part of the template.
 - On each line, there may be a logical AND connection (\bullet), an EXOR (\oplus), or no connection with the vertical line (denoted \square). We build the second gate of the right hand side of the template by taking values from Table 4.3 using the symbols on that line from A and B (since the table is symmetric, there is no need to specify which argument is A and which is B).
 - If the symbol E occurs during the building process, the template cannot be built. It is easy to see why, since if all \oplus are on the same line the moving rule is applicable; the network can be changed to the form AAB, after which an application of the deletion rule transforms the network to the form B.

	□	•	⊕
□	□	•	⊕
•	•	•	□
⊕	⊕	□	E

Table 4.3: Second gate building process

- In other cases, for $\text{TOF}(t_1 + t_2, t_3)$ $\text{TOF}(t_1 + t_3, t_2)$ $\text{TOF}(t_1 + t_2, t_3)$ for example, the algorithm produces a logical AND on the first line and nothing at all on the other lines. This makes no sense. That is, no reduction is possible for this sequence of gates.

4.3 Templates - a New Approach

We further generalize the template tool, but assume the following limitation: the model gates should necessarily be self-inverses. This limits the generality of a template, but for the goals of the generalized Toffoli gate synthesis this does not change the essence, since a generalized Toffoli gate is a self-inverse. Note that Fredkin and Miller gates are also self-inverses, thus, their addition to the model would be “legal” from the point of view of the templates.

Although the template description in Section 4.2 is formal and shorter (3 classes and 2 rules in comparison to 14 templates with 2 rules as used before), it can be simplified even further. For this we need a new understanding of templates.

Let a **size m template** be a sequence of m gates (a circuit) which realizes the identity function. Any template of size m must be independent of templates of smaller size, *i.e.*

for a given template size m no application of any set of templates of smaller size can decrease the number gates. The template $G_0 G_1 \dots G_{m-1}$ (G_i is a reversible gate) can be applied in two directions:

1. **Forward application:** A piece of the network that matches the sequence of gates $G_i G_{(i+1) \bmod m} \dots G_{(i+k-1) \bmod m}$ of the template $G_0 G_1 \dots G_{m-1}$ exactly, is replaced with the sequence $G_{(i-1) \bmod m} G_{(i-2) \bmod m} \dots G_{(i+k) \bmod m}$ without changing the network's output, where parameter $k \in N$, $k \geq \frac{m}{2}$.
2. **Backward application:** A piece of the network that matches the sequence of gates $G_i G_{(i-1) \bmod m} \dots G_{(i-k+1) \bmod m}$ exactly, is replaced with the sequence $G_{(i+1) \bmod m} G_{(i+2) \bmod m} \dots G_{(i-k) \bmod m}$ without changing the network output, where parameter $k \in N$, $k \geq \frac{m}{2}$.

These definitions of template application need a correctness proof that the network output should not change for each of the listed operations. Correctness can be verified as follows. Note that a reversible cascade that realizes a function f read in reverse (from the outputs to the inputs) realizes f^{-1} , its inverse.

First, we prove the correctness of the forward application of a template starting with element G_0 . The operation for this case requires the substitution of $G_0 G_1 \dots G_{k-1}$ with $G_{m-1} G_{m-2} \dots G_k$. Since $G_0 G_1 \dots G_{m-1}$ realizes the identity function, $G_k G_{k+1} \dots G_{m-1}$ realizes the inverse of the function realized by $G_0 G_1 \dots G_{k-1}$. Therefore, if we read in the reverse order, $G_k G_{k+1} \dots G_{m-1}$ realizes the inverse of the inverse, *i.e.* the function itself. Thus, the function realized by $G_0 G_1 \dots G_{k-1}$ was substituted by itself, which does not change the output of the network. The correctness of the remaining forward

applications can be proven by using Lemma 10.

The correctness of all reverse applications follows from the proof above and from the observation that the inverse of the identity function is the identity function.

Next, we observe that a template can be used in both directions, forward and backward as the formulas show. Also, we can start using it from any element. Thus, it is better to think of a template as a cyclic sequence. The Toffoli templates that are classified below are shown in a donut shape form in Fig.4.6. The correctness of viewing a template as a cyclic sequence is proven by the following Lemma.

Lemma 10. If a network $G_0 G_1 \dots G_{m-1}$ realizes the identity function, then for any k -shift, $G_k G_{(k+1) \bmod m} \dots G_{(k-1) \bmod m}$ realizes the identity.

Proof. We prove the Lemma for the 1-shift, $G_1 G_2 \dots G_{m-1} G_0$. Then all k -shifts can be proven by applying the 1-shift k times. The proof for a 1-shift follows from:

$$Id = G_0 G_1 \dots G_{m-1}$$

$$G_0 Id = G_0 G_0 G_1 \dots G_{m-1}$$

$$G_0 = G_1 G_2 \dots G_{m-1}$$

$$Id = G_0 G_0 = G_1 G_2 \dots G_{m-1} G_0.$$

■

The condition $k \geq \frac{m}{2}$ is used as we do not want to increase the number of gates when a template is applied and equality yields a simpler classification scheme.

The following is a classification of templates up to size 7. We use the notation introduced

in the previous subsection.

- $m=1$. Size 1 templates do not exist, since each generalized Toffoli gate produces a change in its input.
- $m=2$. There is one class of templates of size 2 (Figure 4.5a), and it is the deletion rule which is described by the sequence AA, where $A = TOF(C_1, t_1)$.
- $m=3$. There are no templates of size 3.
- $m=4$. There is one class of templates (Figure 4.5b), the moving rule from the previous section, which can be written as the formula ABAB, where $A = TOF(C_1 + C_2, C_4 + C_5)$ and $B = TOF(C_1 + C_3, C_4 + C_6)$. The set notation is used to describe the targets since they may intersect or not, which is impossible to describe in one formula using the t_i notation for the targets. The upper template in Figure 4.5b has $|C_4| = 0$ which results in $|C_5| = 1$ and $|C_6| = 1$, when the lower has $|C_4| = 1$ resulting in $|C_5| = 0$ and $|C_6| = 0$.
- $m=5$. Surprisingly, there is only class of template of size 5 (Figure 4.5c), which unites the three earlier classes 1-3 and includes templates 2.1-2.2, 3.1- 3.3 and 4.1-4.6 from Figure 4.3. The class can be written as ABABC, where $A = TOF(C_1 + C_2 + t_2, t_1)$, $B = TOF(C_1 + C_3, t_2)$, and $C = TOF(C_1 + C_2 + C_3, t_1)$.
- $m=6$. There are two classes here (Figure 4.5d), and they are described by formulas ABACBC with $A = TOF(C_1 + t_2, t_1)$, $B = TOF(C_1 + C_2 + C_3 + t_1, t_2)$, and $C = TOF(C_1 + C_2 + t_2, t_1)$; and ABACDC with $A = TOF(C_1 + t_2, t_1)$, $B = TOF(C_1 + C_2 + C_3 + t_1, t_2)$, $C = TOF(C_1 + C_2 + t_1, t_2)$, and $D = TOF(C_1 + C_2 + C_3 + t_2, t_1)$. Note that the two formulas for the classes look very similar, and,

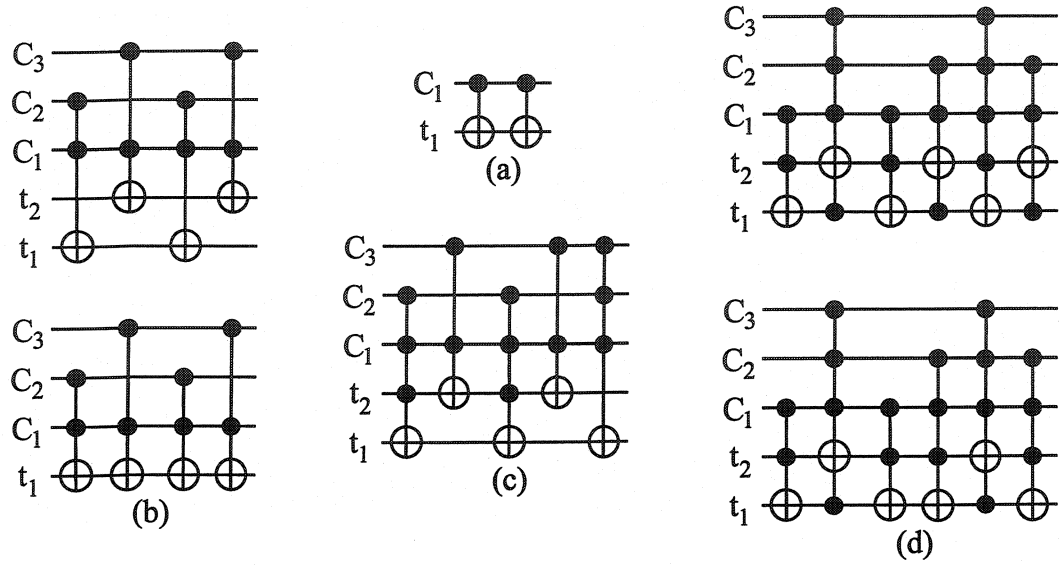

Figure 4.5: All templates for $m \leq 7$.

using Fredkin gates, they can be generalized to form one very simple template $FRE(C_1 + C_2 + C_3, t_1 + t_2) FRE(C_1 + C_2 + C_3, t_1 + t_2)$ (where $FRE(C, t_1 + t_2)$ is a gate which swaps values of bits t_1 and t_2 if, and only if, set C has all ones on its lines), but we do not pursue this here as we are restricting our attention to generalized Toffoli gates.

- $m=7$. There are no templates of size 7.

The described templates are also shown as cyclic circuits in Fig.4.6.

To verify the correctness of the above classification, we must show that no template of larger size can be reduced to a template of smaller size.

- – The size 4 template is independent of the size 2 template, since no adjacent gates are equal.
- – The size 5 template is independent of the size 2 template, since no adjacent

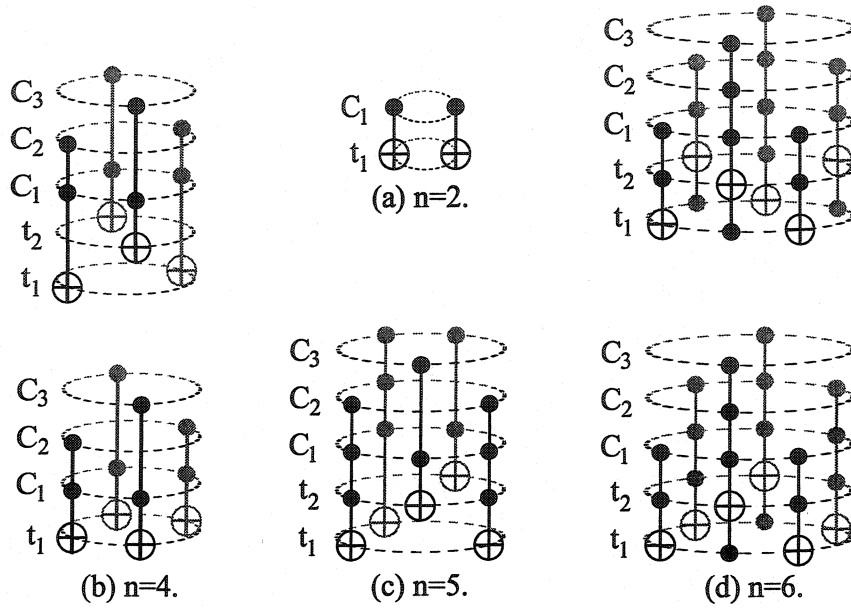

Figure 4.6: All templates for $m \leq 7$ depicted as donuts.

gates are equal.

- The size 4 template can be applied to move gate C anywhere in a template, but it does not allow any simplification of a size 5 template by smaller templates.
- - Size 6 templates are independent of the size 2 template, since no adjacent gates are equal.
- A size 4 template can be applied to interchange gates A and C of template $ABACBC$ only and does not lead to any simplification.
- The size 5 template matches at most 2 gates of template $ABACBC$, and therefore can not be applied.

4.3.1 Completeness

First of all, we wrote a program which builds all the 4-input 4-output circuits of size 7 that realize the identity function and tries to apply the templates. The program result shows that the set of our 5 templates (AA, ABAB, ABABC, ABACBC, ABACDC) is the complete set of templates of size 7 or less for 4 inputs and less.

The mathematical proof of completeness of this set for any number of inputs is harder. For templates of size 2 it can be done by hand, since there are few choices to consider. For templates of size 4 and 5 the following lemmas are useful.

Lemma 11. A size m template has at most $\lfloor \frac{m}{2} \rfloor$ different lines with EXOR signs.

Proof. Proof by contradiction. Suppose there are $\lfloor \frac{m}{2} \rfloor + 1$ or more lines which contain an EXOR sign. Then, by the pigeonhole principle, there will be one line with a single EXOR sign only. Cut the cycle so that the gate with this EXOR, $TOF(C, t)$ comes first. Now, if we assign 1 to all $x_j \in C$, the value of t changes to \bar{t} as the signal is propagated in the template. Thus, the template does not realize the identity function, which contradicts its definition. ■

Lemma 12. If a size m template has only a single line with EXOR signs, m is even and all the gates in it can be grouped as pairs of equal gates.

Proof. Proof by contradiction. Suppose not all the gates can be paired or the number m is odd. Apply passing and duplication deletion rules to delete all the paired gates from the template. The remaining circuit still realizes the identity since all the applied operations did not change the circuit output. When we propagate the signal in the

network, the output on the line with EXOR (for instance, x_n) becomes a polynomial of positive polarity on the remaining variables (for instance, x_1, x_2, \dots, x_{n-1}). In other words, the Zhegalkin polynomial on the set of variables $\{x_1, x_2, \dots, x_{n-1}\}$ was added to the input x_n . Since no non-zero Zhegalkin polynomial equals zero, the output on the n -th line will differ from its input. This contradicts the definition of a template since it is supposed to realize the identity function. ■

Using Lemma 11 allows us to say that all templates of size 4 have EXOR signs on either two lines (two signs on one and two on the other) or 1 line (all 4 on 1 line). In the last case we use Lemma 12. Thus, an exhaustive search proof becomes reasonable. For the size 5 templates we can guarantee that they all will have exactly two lines with EXOR. Note that Lemma 12 proves that the only two templates which have only one line affected with EXOR are the duplication deletion rule and the passing rule; all other identities of this type are applications of the above rules.

4.4 Experimental Results

We wrote programs to implement the algorithm, build the new templates and apply them. Several results are discussed below.

The program which simplifies the networks works as follows. First, we found that it is convenient to store template ABAB as a separate rule which helps to bring the gates together to match a template. Then, the circuit is simplified as follows. For the template order $AA \succ ABABC \succ ABACBC \succ ABACDC$, we try to match as many gates of a template as possible by looking ahead in the network and using the moving rule. If a template can be applied, we apply it for the greatest number of gates matched

k possible. After applying any template, we start trying to apply the templates in hierarchical order from the very beginning. If none of the templates can be applied, the simplification process is finished.

Such order for the template application was chosen based on the following observation. The larger size templates are independent of the smaller size templates, therefore the smaller size templates describe simpler or more general circuit simplifications when larger templates describe more specific and less general circuit simplifications.

Example 14. We synthesized a network for the 3-bit adder (Figure 4.7) and applied our template tool to simplify the circuit. The algorithm creates a circuit with 5 gates 4.7(a).

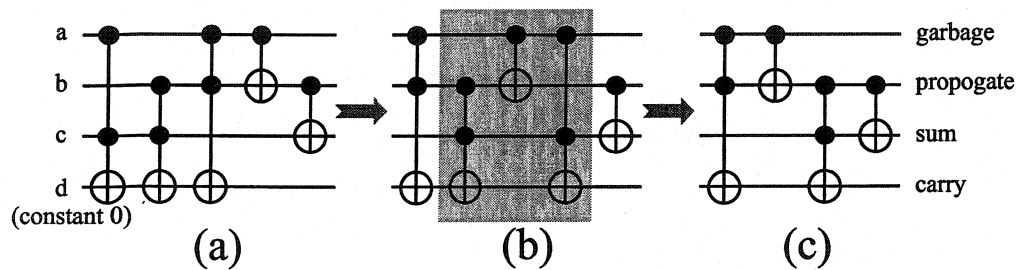

Figure 4.7: Optimal circuit for a full adder.

The template simplification part of the program used a size 5 template and matched 3 gates (highlighted grey in 4.7(b)). Thus, they were substituted by the remaining 2 gates of the template, read in reverse order. The circuit 4.7(c) is optimal, since no further reduction is possible. Suppose an adder can be realized with 3 gates or less. Then the addition of these gates to the end of the built size 4 cascade results in a new template which was proven (by enumeration) not to exist for size 7 and less and four inputs. The presented circuit for the 3-bit full adder is better than the one given in [8], a circuit consisting of 5 Fredkin gates (as opposed to 4 Toffoli gates for our circuit) and having

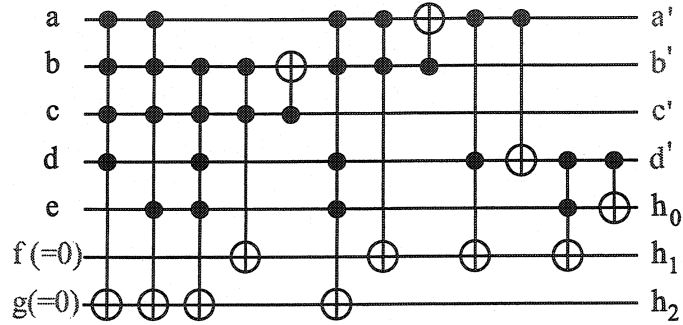

Figure 4.8: Circuit for *rd53*.

4 garbage bits (as opposed to 1 garbage bit for our circuit).

Example 15. As a second example we consider the benchmark function *rd53*. This function has 5 inputs and 3 outputs. The outputs are the binary encoding of the weight of the input pattern i.e. the number of 1s in the input pattern. For example, input 00000 yields output 000, input 00100 yields output 001 and input 11111 yields output 101. The maximum output pattern multiplicity is 10, so at least 4 garbage outputs must be added giving a total of at least 7 outputs. That in turn requires two inputs be added. Initially the reversible specification given in [50] was used. The garbage outputs were subsequently modified to remove unnecessary gates. Our algorithm produces a circuit with 12 gates in 1.84 seconds of CPU time. This is better than the circuit with 14 gates proposed in [54]. It is also better than 13 gates, the result from the previous chapter.

The larger the set of templates, the more reductions can be done. For instance, if for some natural number k , k -optimality is defined as the impossibility of simplifying a network with templates of size $(2k - 1)$ and less, then all the templates of size $(n - 1) * 2^{n+1} + 1$ and less form the complete simplification tool for the presented synthesis

Chapter 4. Toffoli Synthesis

algorithm.

Chapter 5

Toffoli-Fredkin Synthesis

5.1 How Useful Are Fredkin Gates?

In this chapter it is shown how to use Fredkin gates in conjunction with Toffoli gates to produce a smaller network. An important question which arises as soon as the “Toffoli-Fredkin Synthesis” is proposed is, how useful are Fredkin gates, if they are useful at all? To answer this question, we wrote a program to calculate the optimal circuits for all 3-input 3-output reversible functions in terms of the cascades of Toffoli and Fredkin gates and compared them to previously reported results on the optimal Toffoli synthesis [74, 75] in Table 5.1. The table shows how many functions of size 3 can be realized with $k = 0, 1, \dots, 8$ gates in optimal synthesis using NOT, CNOT and Toffoli gates (NCT column, calculated in [74, 75]), NOT, CNOT, Toffoli, and SWAP gates (NCTS column, calculated in [74, 75]), and NOT, CNOT, Toffoli, SWAP, and Fredkin gates (NCTSF column, calculated by us). The “Total:” row of the Table shows how many different functions in total are presented in the column (to make sure we have all 40320 reversible functions of size 3); the “WA:” row shows the weighted average cost of a reversible function in terms of the corresponding model. Analysis of this table shows that the average cost in NCTSF is approximately 0.732 gates lower than the one in NCT. The maximum cost drops from 8 to 7. The NCTS column looks odd, since the

Size	NCT	NCTS	NCTSF
0	1	1	1
1	12	15	18
2	102	134	184
3	625	844	1318
4	2780	3752	6474
5	8921	11194	17695
6	17049	17531	14134
7	10253	6817	496
8	577	32	0
Total:	40320	40320	40320
WA:	5.866	5.629	5.134

Table 5.1: Optimal synthesis of all 3-input 3-output functions

SWAP gate is a gate of a different nature (Fredkin-like structure), but it is presented in this table to reflect the calculation from [74, 75].

5.2 Box Gate

Observe that Toffoli and Fredkin gates are closely related. In fact, they can be written as one general gate $G(S; B)$. Later on in Section 5.4, we will see how useful it is to unite these two gates together. The uniform way of writing Toffoli and Fredkin gates will be captured in the definition of a **box gate** $G(S; B)$, which for $|B| = 1$ is the $TOF(S; B)$ gate and for $|B| = 2$ is $FRE(S; B)$. Such a way of writing the gates is needed when

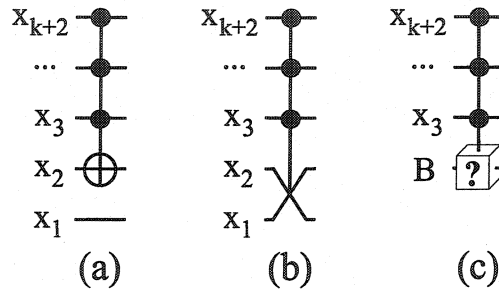

Figure 5.1: Toffoli, Fredkin and box gates.

we consider a general gate from the Fredkin-Toffoli family and do not want to specify which gate it is. So, if the size of the set B is not specified, it can be either 1 or 2. The gate shown in Fig.5.1c is $G(C; B)$, where the set B is not specified. If a box gate is found in a network, the following rules help to decide which one of two possible gates (Toffoli or Fredkin) it represents and the way the network assigns EXOR or SWAP to the box.

- If the EXOR operation is assigned to a box symbol, all the boxes on this line become EXORs and nothing else changes.
- If the SWAP operation is assigned to a box symbol, all the boxes on this line are changed to SWAPs. SWAPs require two lines to be properly written, therefore, we add one line so that the two lines with the newly built SWAP have controls everywhere the line with the box had, and only there.
- In a correctly built circuit a box symbol will never be on the same line with EXOR or SWAP symbols.

Further, if the setting for the box (Toffoli or Fredkin) is not specified, the box can be assigned to either Toffoli or Fredkin according to the above rules.

5.2.1 A Note on Similarity of Fredkin And Toffoli Gates

Fredkin gates alone do not form a complete set. Fredkin gates act as controlled SWAPs which do not change the number of ones in the pattern (like the structure proposed in [33] and [72], where gates that do not change the number of ones were considered). For example, the set of all Fredkin gates is not sufficient if the NOT operation is needed. Will the set of NOT and all Fredkin gates be complete? Given a network of Toffoli gates is it possible and easy to find a transformation to the NOT-Fredkin network which will compute the same function (assuming garbage is unlimited)? A positive answer for the second question implies a positive answer on the first question, since the set of Toffoli gates is complete (shown constructively in Chapter 4). Here we answer the second question: given a circuit with Toffoli gates, we can build a circuit with NOT-Fredkin gates. The construction is as follows.

- Code each Boolean pattern 0 with the pair of Boolean values (1,0) and each Boolean pattern 1 with (0,1).
- Given a Toffoli circuit, split each horizontal line into two. If the splitting line had no symbol on it, do not put any symbol on the resulting two lines. If the splitting line had \oplus sign on it, substitute it with SWAP (which is possible to do after the line was split). If the line was a control (\bullet), after splitting substitute the first line with a line of the form NOT- \bullet -NOT, and second line with the control only (\bullet).
- After these transformations are done, the circuit will consist of the NOT and Fredkin gates only, since all the occurrences of \oplus were replaced with SWAP.

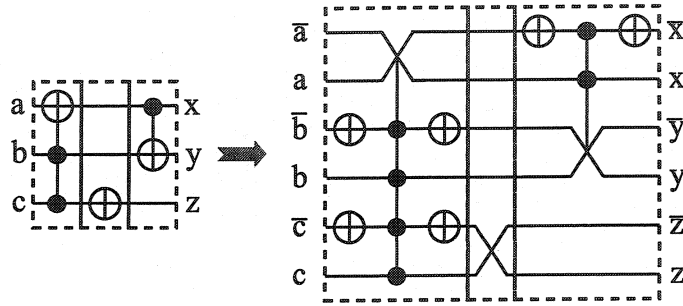

Figure 5.2: Transformation of a Toffoli circuit to a NOT-Fredkin circuit.

For an example of this circuit transformation, see Fig. 5.2. The NOT-Fredkin circuit has several nice properties. The Boolean inputs of the function to be calculated are on even lines, and the corresponding Boolean outputs are even outputs. The second circuit computes both a function and its negation simultaneously (which in practice may not be that useful). An interesting observation is that if the inputs and outputs of the resulting circuit are (naturally) paired and a pair of equal outputs is found, it can be concluded that at least one of the gates malfunctioned. This property may be useful in a design-for-testability.

5.3 The algorithm

In this section we consider several Fredkin-Toffoli family synthesis problems: synthesis of reversible functions, synthesis of multiple output functions, and synthesis of incompletely specified multiple output functions.

The algorithm to be presented is a modified version of the algorithm from Chapter 4.

As usual, the function is specified as a truth table, which contains input patterns on the left, and output patterns on the right side. All the Boolean patterns are considered to be arranged in lexicographical order.

Start with the basic algorithm which works with completely specified reversible functions only. The synthesis procedure will start with the empty circuit which realizes the identity function. At every step of the synthesis algorithm we add a few of gates from the Fredkin-Toffoli family to the end of the cascade already constructed. Since the reversible cascade can be built from either end, we have to agree on where to start. For the basic algorithm it is better to start synthesizing the function from the outputs and working towards the inputs, so that the cascade is to be read in reverse order.

Basic algorithm.

Step 0. *Idea: take the narrowest gates and arrange them in a cascade so that they bring the first output pattern to the first input pattern.*

The first pattern of truth table is the lowest in the order sequence $(0, 0, \dots, 0)$, while the first pattern in the output part is, in general, an unknown pattern (b_1, b_2, \dots, b_n) . To bring it to the form $(0, 0, \dots, 0)$, we use gates $TOF(x_i)$ for every i such that $b_i \neq 0$.

When the first gates are added to the cascade, we update the output part of the table to see that the pattern (b_1, b_2, \dots, b_n) was transformed to the desired form $(0, 0, \dots, 0)$.

Step S. *Idea: without influencing the patterns of the lower order that were put at their desired places in the previous steps of the algorithm, use the least number of the narrowest gates to bring the output pattern to the form of the corresponding input pattern.*

The input pattern of the table, (a_1, a_2, \dots, a_n) is the binary representation of the natural number $(S+1)$. The pattern in the last update of the output part is any pattern (b_1, b_2, \dots, b_n) of higher order. If the order is the same, the patterns are equal, and there

is nothing left to do at this step. The order of (b_1, b_2, \dots, b_n) cannot be less than the order of (a_1, a_2, \dots, a_n) since all such patterns were put to their places in the previous steps of the algorithm.

For the pattern (b_1, b_2, \dots, b_n) to be transformed to (a_1, a_2, \dots, a_n) , note that each application of a Toffoli gate is capable of flipping one bit of the pattern (b_1, b_2, \dots, b_n) , and each Fredkin gate is capable of permuting a pair of unequal Boolean values. Now, the problem can be formulated as follows: using the two operations “flip” and “swap”, bring a Boolean pattern $(b_1, b_2, \dots, b_n) \succ (a_1, a_2, \dots, a_n)$ to the form (a_1, a_2, \dots, a_n) so that all intermediate Boolean patterns are greater than (a_1, a_2, \dots, a_n) . The controls for the corresponding gates will be assigned later. The solution is as follows.

- If the number of ones in (b_1, b_2, \dots, b_n) is less than the number of ones in (a_1, a_2, \dots, a_n) try to apply as many “swaps” as we can and then flip the remaining zero bits to one. Use “swaps” so that the order of each intermediate pattern (x_1, x_2, \dots, x_n) is less than the order of (a_1, a_2, \dots, a_n) , and define the set of controls as a minimal subset of unit values of (x_1, x_2, \dots, x_n) , such that this subset forms a Boolean pattern of an order higher than (a_1, a_2, \dots, a_n) . This can be easily done if “swaps” are done on the lower end of the pattern first. Note that in this case the initial pattern (b_1, b_2, \dots, b_n) was greater than (a_1, a_2, \dots, a_n) , so the most significant binary digit of (b_1, b_2, \dots, b_n) equal to one was greater than the most significant digit of (a_1, a_2, \dots, a_n) equal to 1. Thus, this digit will be taken as the control (when a control is needed) for all corresponding Fredkin and Toffoli gates except the last Toffoli gate, for which the control will consist of all digits of (a_1, a_2, \dots, a_n) that are equal to 1.

- If the number of ones in (b_1, b_2, \dots, b_n) is equal to the number of ones in (a_1, a_2, \dots, a_n) , then it is possible to transform one pattern into other using “swap” operation only. Controls are then found by the procedure described in the above case.
- If the number of ones in (b_1, b_2, \dots, b_n) is greater than the number of ones in (a_1, a_2, \dots, a_n) , then apply “swaps” starting from the end of the pattern (b_1, b_2, \dots, b_n) and then apply necessary Toffoli gates. All the necessary controls can be found using the procedure from the first case.

Step $2^n - 1$. When all $(2^n - 1)$ previous patterns are in their places, the last patterns will automatically match.

Motivation. In technology it usually happens that the narrower the gate, the lower its cost, and thus we try to use the narrowest gates. However, choosing the narrowest gates at each step may lead to larger initial circuits which might not be simplified enough by the template tool. Therefore, in the actual implementation of this algorithm we define which gate to take by choosing the one producing a circuit whose output has the shortest Hamming distance to the desired input pattern we are attempting to match. Such a method of choosing a gate has no theory behind it, but we use it because it makes sense. It also happens that the template simplification tool is sensitive to the width of the gates, so we prepare the circuit for better template reduction by taking narrow gates.

Bidirectional modification. The basic algorithm works from the output to input by adding the gates in one direction starting from the end of desired cascade and ending at its beginning. What if we were able to understand what happens if during the procedure

a gate is added to the beginning of cascade? Then we would be able to construct the network from the two ends simultaneously by growing the number of gates from the two sides. The idea of the method stays the same; by applying the gates, we bring the input and output parts of the truth table to each other by assuring that at each step of the calculation we put at least one pattern at its place. It makes sense that such a bidirectional algorithm in average will converge faster. We next take any function written as a truth table, apply a gate and see what change it makes in the output part of the truth table.

- Toffoli gate application. Without loss of generality we apply gate $TOF(C; x_{k+1})$, $C = \{x_1, x_2, \dots, x_k\}$ with the controls on first k variables and target on the $(k + 1)$ variable (all other generalized Toffoli gates have permuted set of controls and, maybe, a different target). Then, in the input part of the truth table the patterns $(1, 1, \dots, 1, x_{k+1}^0, x_{k+2}^0, \dots, x_n^0)$ will interchange with patterns $(1, 1, \dots, 1, \bar{x}_{k+1}^0, x_{k+2}^0, \dots, x_n^0)$.

In terms of our understanding, this is the same as permuting the output patterns in front of the $(1, 1, \dots, 1, x_{k+1}^0, x_{k+2}^0, \dots, x_n^0)$ and $(1, 1, \dots, 1, \bar{x}_{k+1}^0, x_{k+2}^0, \dots, x_n^0)$ input patterns without changing the input part. This procedure is easier to visualize, since the matched patterns do not get mixed up in the middle of the truth table, which would make it hard to track a pattern. For the program implementation, the input part may be changed (from the point of view of the computer this does not confuse any patterns).

- Fredkin gate application. We apply a Fredkin gate $FRE(C; x_{k+1}, x_{k+2})$, $C = \{x_1, x_2, \dots, x_k\}$. This results in the following change of all patterns in the input part of the table: $(1, 1, \dots, 1, x_{k+1}^0, x_{k+2}^0, x_{k+3}^0, \dots, x_n^0)$ is interchanged with

$(1, 1, \dots, 1, x_{k+2}^0, x_{k+1}^0, x_{k+3}^0, \dots, x_n^0)$. If we want to keep the conventional form of the input part of the truth table when patterns are arranged lexicographically, this operation is the same as interchanging the output patterns of the truth table which stay in front of the input patterns $(1, 1, \dots, 1, x_{k+1}^0, x_{k+2}^0, x_{k+3}^0, \dots, x_n^0)$ and $(1, 1, \dots, 1, x_{k+2}^0, x_{k+1}^0, x_{k+3}^0, \dots, x_n^0)$.

The bidirectional algorithm thus has the same number of steps, where at each step it tries to change the output pattern so that it matches the input pattern by applying the least number of the narrowest gates assigned at either side of the cascade.

The presented algorithm is an improved version of the algorithm suggested in Chapter 4, since the new algorithm uses the Fredkin gates.

Function 3.17 introduced in Chapter 4 had the cost of 17 when realized as a Toffoli cascade. Now, it will serve as a good example of how helpful it is to use the Fredkin gates.

Example 16. We apply the basic method for the 3.17 function, shown in the truth table in Table 5.2.

- Step 0. The output pattern corresponding to the input pattern $(0, 0, 0)$ is $(1, 1, 1)$. In order to bring it to the form $(0, 0, 0)$ we use 3 NOTs: $TOF(a)$, $TOF(b)$ and $TOF(c)$. Not, that this is not a unique way of changing the output pattern to make it match the input, since, for instance, $TOF(b, c; a)$, $TOF(c; b)$ and $TOF(c)$ would do the same. Thus, the program realization may branch or use a heuristic to choose the gates, although, for this case the sequence of 3 NOTs defines the unique way of transforming the output pattern so that the least number of controls is

used. An update in the table (Tab.5.2 S1) illustrates that the new output pattern matches the new input pattern.

- Step 1. For input pattern $(0, 0, 1)$ we have the output pattern $(1, 1, 0)$. In order to bring the last to the form of input, we swap bits b and c by $FRE(b, c)$ and then use $TOF(c, a)$ to bring the “swapped” pattern $(1, 0, 1)$ to the form $(0, 0, 1)$. Neither of the used gates changes anything in the order less than $(0, 0, 1)$. Also note that this is not a unique way of changing the output pattern to match the input pattern even for the smallest set of controls: $FRE(a, c)$, $TOF(c; b)$ would do the same job. Again, this is a place for a program to make a good choice.
- Step 2. The next input pattern, $(0, 1, 0)$, does not match the corresponding output pattern, $(1, 1, 1)$ (Tab.5.2 S2). We apply the gates $TOF(b; c)$, $TOF(b; a)$ to make the match.
- Step 3. We apply $TOF(a; c)$ and $FRE(c; a, b)$ to match the output pattern $(1, 0, 0)$ of Tab.5.2 S2 to the desired input pattern $(0, 1, 1)$.
- Step 4. We use $TOF(a; c)$ and $TOF(a; b)$ to bring $(1, 1, 1)$ (Tab.5.2 S4) to the form $(1, 0, 0)$.
- Step 5. Finally, we use the $FRE(a; b, c)$ to transform $(1, 1, 0)$ from Tab.5.2 S5 to $(1, 0, 1)$.
- Steps 6,7 are empty since the output completely matches the input at the previous step (Tab.5.2 S6).

The resulting circuit has 12 gates, as opposed to 17 for the basic approach in a model when only Toffoli gates are used. The circuit is illustrated in Fig. 5.3(a).

In	Out	S0	S1	S2	S3	S4	S5
000	111	000	000	000	000	000	000
001	001	110	001	001	001	001	001
010	100	011	111	010	010	010	010
011	011	100	100	100	011	011	011
100	000	111	011	110	111	100	100
101	010	101	110	011	101	110	101
110	110	001	010	111	110	101	110
111	101	010	101	101	100	111	111
apply		$T(a)$	$F(b, c)$	$T(b; c)$	$T(a; c)$	$T(a; c)$	$F(a; b, c)$
gates:		$T(b)$	$T(c; a)$	$T(b; a)$	$F(c; a, b)$	$T(a; b)$	
		$T(c)$					
* Toffoli gates are coded with letter "T", and Fredkin with "F".							

Table 5.2: Basic approach synthesis.

Example 17. We use the bidirectional algorithm to build a circuit for 3.17.

- Step 0. To match the output pattern (1, 1, 1) with the input pattern (0, 0, 0), the basic algorithm required 3 steps. Here, we can do it with one step only by assigning $TOF(a)$ to the beginning of the cascade. This transformation interchanges the output patterns in front of input patterns $(0, \alpha, \beta)$ and $(1, \alpha, \beta)$ resulting in the output transformation shown in Table 17 S1.
- Step 1. To change (0, 1, 0) to the form (0, 0, 1), we swap the last two bits (using $FRE(b, c)$) in the end of cascade.

- Step 2. To change $(1, 0, 1)$ in Table 17 S2 to the form $(0, 1, 0)$, one gate is not enough. Several choices are possible at this step, and so we demonstrate using only one of them. We apply gates $FRE(a; b)$ and $TOF(b; c)$, both at the end of the cascade.
- Step 3. The two gates $FRE(b; a, c)$ assigned at the beginning of the network and $TOF(b, c; a)$ are making exactly the same change, and both bring target pattern $(1, 1, 1)$ of Table 17 S3 to the desired form $(0, 1, 1)$. We pick one, and assign $FRE(b, ac)$ to the beginning of the cascade.
- Step 4. Pattern $(1, 1, 0)$ can be brought to the form $(1, 0, 0)$ by using the gate $TOF(a; b)$ in the end of cascade.
- Step 5. Gate $FRE(a; b, c)$ assigned to the end of cascade or to the beginning of cascade makes the same change; it brings $(1, 1, 0)$ to the desired form $(1, 0, 1)$. Since this step is the last (column S6 matches the input column exactly), this equivalence of assigning a gate to the end of cascade and its beginning makes sense: in a circuit the last element of a part built from the beginning is the first element of the cascade part built from its end. In other words, the two parts of the cascade meet at gate $FRE(a; b, c)$.
- Steps 6,7 are empty.

The cascade consists of 7 gates, and the circuit is shown in Fig.5.3(b).

In	Out	S0	S1	S2	S3	S4	S5
000	111	000	000	000	000	000	000
001	001	010	001	001	001	001	001
010	100	110	101	010	010	010	010
011	011	101	110	111	011	011	011
100	000	111	111	110	110	100	100
101	010	001	010	100	100	110	101
110	110	100	100	011	111	101	110
111	101	011	011	101	101	111	111
apply		$\rightarrow T(a)$	$\leftarrow F(b, c)$	$\leftarrow F(a, b)$	$\rightarrow F(b, a, c)$	$\leftarrow T(a; b)$	$\rightarrow F(a; b, c)$
gates:				$\leftarrow T(b; c)$			
* Toffoli gates are coded with letter "T", and Fredkin with "F".							

Table 5.3: Bidirectional approach synthesis.

5.3.1 Handling permutations

By permuting the output patterns, one can achieve a reduced cost for the resulting circuit. The output pattern permutation is the result of applying a certain number of SWAPs to the end of the cascade, thus, to achieve a fair comparison of the costs of circuits built with and without output permutations, the corresponding number of swaps should be added to the cost of a circuit built with output permutations. Currently, we have no rule for choosing the best permutation, and so for small functions we try all possibilities.

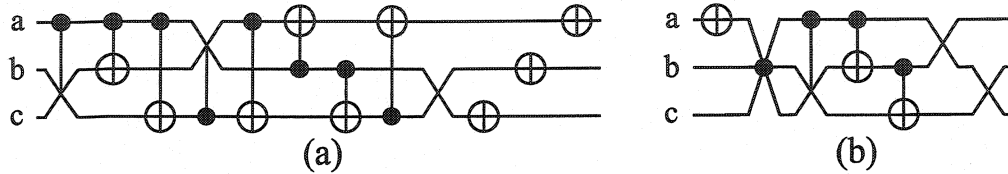

Figure 5.3: Circuits.

5.3.2 Multiple output and incompletely specified functions

For multiple output functions there are two ways of creating a reversible circuit. First, make the function reversible using Theorem 1, and then run the bidirectional algorithm. Second, find the minimum amount of garbage and add garbage outputs without specifying them. Then, take this incompletely specified reversible function and start running the forward method by specifying the output patterns as soon as we want to assign a gate in a way which produces the minimum cost circuit possible. Actual procedures of assigning the output patterns so that it minimizes the network cost are currently under investigation.

The following a rough idea on how the computation can be performed; the actual implementation is currently under investigation and is not part of the presented thesis.

5.4 Template simplification tool

We keep the same definition of a template as the one introduced in Section 4.3. Namely, let a **size m template** be a sequence of m gates (a circuit) which realizes the identity function.

The set of Toffoli and Fredkin gates is more complicated than the set of Toffoli gates only, therefore we redefine the notion of a class of templates.

Definition 11. A class of templates of size m is a circuit $G(S_1; B_1) G(S_2; B_2) \dots G(S_m; B_m)$ with the set of logical conditions on sets $S_1, B_1, S_2, B_2, \dots, S_m, B_m$. When a class is mentioned, it may be written as $G_{i_1} G_{i_2} \dots G_{i_m}$, where $i_k = i_j$ iff $S_k = S_j$ and $B_k = B_j$.

This approach to defining a class is useful for its short classification, but it is difficult to visualize. Thus, we introduce the following notation.

Definition 12. A class can be written as a set of disjoint formulas $G_1(S_1, B_1) G_2(S_2, B_2) \dots G_m(S_m, B_m)$, where:

- according to the number of elements in B_i , G_i is written as $TOF(|B_i| = 1)$ or $FRE(|B_i| = 2)$;
- S_i is written as a union of sets (C_{i_k}) and single variables (t_{i_j}) each of which is a set of one variable only: $S_i = C_{i_1} + C_{i_2} + \dots + C_{i_k} + t_{i_1} + t_{i_2} + \dots + t_{i_j}$;
- if $|B_i| = 1$, it is written as single variable, t_j ; if $|B_i| = 2$ it is written as union $t_j + t_k$;
- all the sets are disjoint: $C_i \cap C_j = \emptyset, C_j \cap t_k = \emptyset, t_k \cap t_l = \emptyset$.

In order to classify templates, we need to discuss the box notation in more detail. If a box is found in a network, there are certain rules of changing the network when the operation EXOR or SWAP is assigned to the box.

- If the assignment was EXOR, then the box is substituted with the EXOR symbol.
If the line with the box assigned EXOR contains other box symbols, they are all

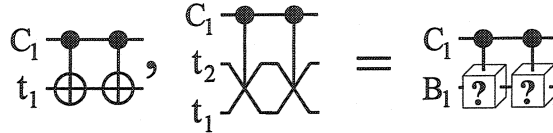

Figure 5.4: Class AA.

substituted with EXOR.

- If the assignment was SWAP, the line with the box becomes two lines where the symbol SWAP is placed. Every occurrence of a control on the line with this box is substituted with two lines and two controls on them, and every occurrence of other box symbols is substituted with SWAP. The EXOR symbol cannot appear on this line, since (by the first item) had it been there, all the boxes would be substituted with EXOR; thus a SWAP substitution would be incorrect initially.

Further, if a box symbol in a circuit is not specified, it can be either EXOR or SWAP, which are substituted into the circuit by the above rules.

m=1. There are no templates of size 1, since every gate changes at least two input patterns.

m=2. There is one class of templates of size 2, the **duplication deletion rule**, AA, which is defined as $G(S_1, B_1) G(S_1, B_1)$. This class is a generalization of the duplication deletion rule and it is truth for any two (Toffoli-Fredkin) gates. In disjoint notations this class can be written as two formulas, one for two Toffoli gates and one for two Fredkin gates: $TOF(C_1, t_1) TOF(C_1, t_1)$ and $FRE(C_1, t_1 + t_2) FRE(C_1, t_1 + t_2)$ as shown in Fig. 5.4.

m=3. There are no templates of size 3.

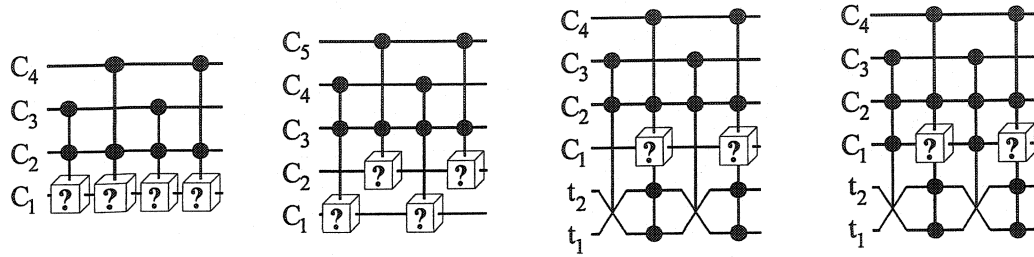

Figure 5.5: Class ABAB.

$m=4$. There are several classes of size 4 templates.

- A very important class is the **passing rule**, a class ABAB $G(S_1; B_1) G(S_2; B_2) G(S_1; B_1) G(S_2; B_2)$ with conditions: $(S_2 \cap B_1 = \emptyset, S_1 \cap B_2 = \emptyset, B_1 = B_2)$ OR $(S_2 \cap B_1 = \emptyset, S_1 \cap B_2 = \emptyset, B_1 \cap B_2 = \emptyset)$ OR $(|B_1| = 2, B_1 \subseteq S_2)$. There can be a shorter but less formal condition: the template $G(S_1, B_1) G(S_2, B_2) G(S_1, B_1) G(S_2, B_2)$ exists if for the first (if there are two with this property) line containing a control (dot) and a BOX, the BOX is SWAP, and sets B_1, B_2 either disjoint or equal. All the cases are shown in Fig.5.5. The first part of the OR condition covers the first picture, the second OR condition describes the second. The third and fourth pictures illustrate the case when the third condition holds.

There is a regular procedure for finding all templates of the form ABAB. Since ABAB is the identity, the circuit produced by the sequence of gates AB should be a self-inverse permutation. The search for templates of the form ABAB becomes equivalent to the search for self-inverse permutations that can be realized as a set of two different gates.

- The following sets of templates can be treated as one, two or even three classes, depending on one's view of the templates. The sets are:

- Semi-passing rule: a group FAFB of gates $FRE(S_1; B_1) G(S_2; B_2) FRE(S_1; B_1) G(S_3; B_3)$ with conditions $S_1 \subseteq S_2$, $B_2 \not\subseteq S_1$, and the gate $G(S_3; B_3)$ is the gate $G(S_2; B_2)$ with controls and targets permuted according to the swap operation defined by the 2-bit set B_1 . This description clarifies the name of the group; if the template is applied for parameter $k = 2$, the change of the network that we see can be described as: gates $FRE(S_1; B_1)$ and $G(S_2; B_2)$ are interchanged, but gate $G(S_2; B_2)$ may be slightly changed. The above group of gates has a non-empty intersection with the passing rule class. For example, the second template in Fig. 5.5, where the first box is Fredkin and the second is Toffoli and the set C_4 is empty, is a template of a semi-passing group. The new templates added by this group are shown in Fig. 5.6. Note that some of the semi-passes leave the gate $G(S_2; B_2)$ unchanged. Also, if we take the set of all semi-passing group templates and subtract the set of all templates of the passing rule group, the resulting set will have the semi-passing group templates where the second gate always changes.
- A group which can be treated as a **definition of the Fredkin gate** in terms of Toffoli gate networks, $TTTTF, TOF(S_1; B_1) TOF(S_2; B_2) TOF(S_1; B_1) FRE(S_3; B_3)$ with conditions $B_1 \subseteq S_2$, $B_2 \subseteq S_1$, $B_1 \neq B_2$, $(S_1 \setminus B_1) \subseteq (S_2 \setminus B_2)$, $S_3 = S_2 \setminus (B_1 \cup B_2)$, $B_3 = B_1 \cup B_2$. Pictorial representation of this class can be found in Fig.5.7.
- As a link between the semi-passing rule and Fredkin definition groups, we have the group of templates $FFFF, FRE(S_1; B_1) FRE(S_2; B_2) FRE(S_1; B_1) FRE(S_3; B_3)$ with conditions: $|S_1 \cap S_2| = 1$, $S_1 \cap B_2 \neq \emptyset$, $S_1 \cap B_2 \neq$

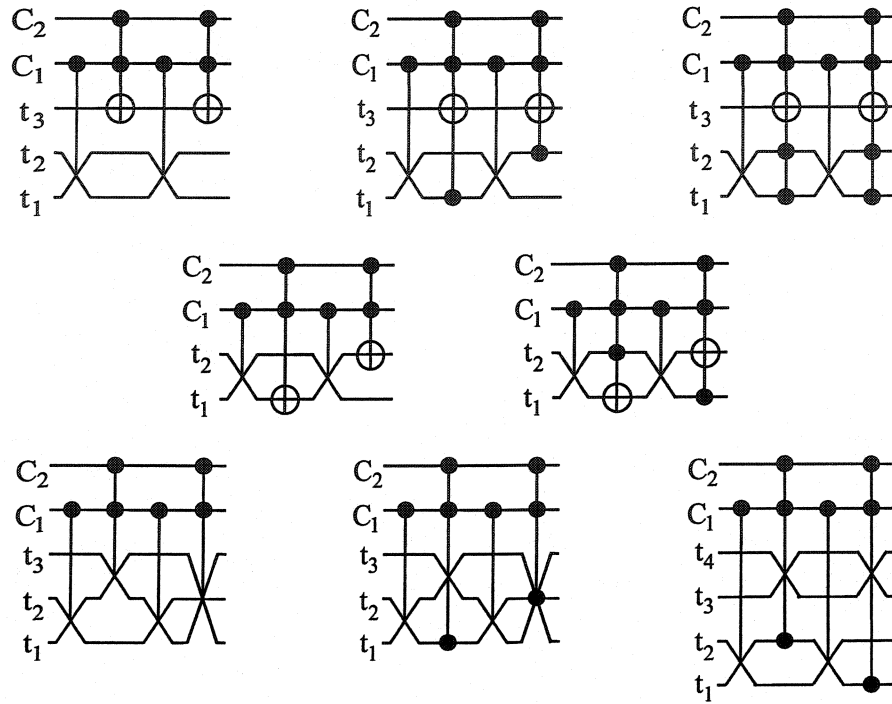

Figure 5.6: A group of semi passes.

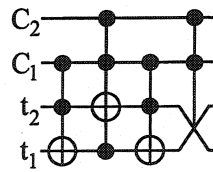

Figure 5.7: Fredkin definition group.

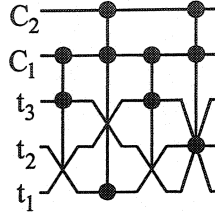

Figure 5.8: Link group.

\emptyset , $(S_1 \cup B_1) \subseteq (S_2 \cup B_2)$ and $FRE(S_3; B_3)$ is the gate $FRE(S_1; B_1)$ with the controls and targets permuted by the swap defined by the set B_1 (Fig. 5.8). This group is not a part of the semi-passing rule, since, for instance, condition $S_1 \in S_2$ does not hold, but essentially it is doing the same thing. For a certain configuration of the first two gates, it allows passing of one gate through the other by permuting the elements of one gate. From the other point of view, this group is similar to the Fredkin definition group in the sense that if we cut out line t_2 and each occurrence of half of the SWAP (which requires two lines, so the half is one line) changes with an EXOR symbol, it results in the Fredkin definition group.

Given these three groups, the classification is not unique. We suggest unifying the semi-passing group with the link group under the name of **semi-passing class** and leaving the Fredkin definition group as a separate **Fredkin definition class**. Other classifications are possible, with the only condition that the semi-passing and Fredkin definition groups can be in the same class only if the link group is a part of it.

m=5. Amazingly, there is only one class of templates of size 5. Class $ATATB$, $G(S_1; B_1) TOF(S_2; B_2) G(S_1; B_1) TOF(S_2; B_2) G(S_3; B_3)$ has conditions $B_2 \subseteq S_1$, $B_1 \not\subseteq$

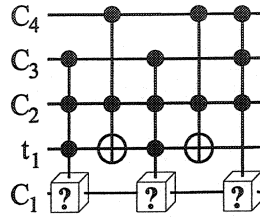

Figure 5.9: Class *ATATB*.

$S_2, S_3 = (S_1 \cup S_2) \setminus B_2, B_3 = B_1$. Although this is the largest class we have, and one would expect to see fewer applications of larger classes, since it is harder to match them then to match smaller classes, in practice this class is the most useful. The pictorial representation of this class is shown in Fig.5.9.

m=6. Using the idea of regular search for the ABAB type templates, it was possible to find and generalize a template of size 6 of the form ABCABC, where ABC is a self-inverse permutation. Using this idea, we have the template *FTTFTT* of the form $FRE(S_1; B_1) TOF(S_2; B_2) TOF(S_3; B_3) FRE(S_1; B_1) TOF(S_2; B_2) TOF(S_3; B_3)$ with conditions $B_2 \subseteq B_1, S_2 \cap B_1 = \emptyset, B_3 \subseteq B_1, B_2 \neq B_1, S_3 \cap B_1 = \emptyset, (S_2 \Delta S_3) \subseteq S_1$. This class is illustrated in Fig. 5.10. The program which searches for the self dual functions of size three has found only those functions that are described by the presented template or circuits which can be simplified by other templates. Thus, we conclude that we have found all the size 3 templates of the form ABCABC.

5.5 Results

We wrote a program which synthesizes a circuit using the bidirectional algorithm and then uses the template tool as a primary circuit simplification procedure. Logically, it consists of the following parts.

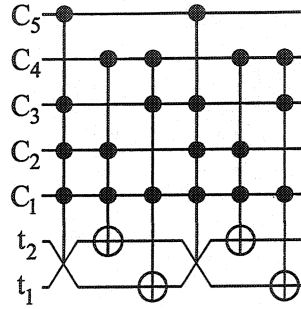

Figure 5.10: Class *FTTFTT*.

1. Synthesize the initial circuit by the bidirectional algorithm.
2. Apply templates. Currently, the template application part looks for a sequence of gates which matches the first k elements of each template, read in both directions starting from each gate. When a gate in the circuit is matched to a gate of a template, the program tries to move it using the moving rule and semi-passing group template application. The gate is moved unchanged (which is a simplification from the point of view of the program implementation, that is, probably not optimal from the point of view of circuit simplification). When and if k gates for $k \geq \frac{m}{2}$ are found and moved together, the template is applied. Such a procedure is used in both directions for one circuit, forward and backward.
3. Functions which are different output permutations of the function to be realized are synthesized and run through the template simplification procedure.
4. For the second test, a minimal circuit out of the circuit for the function itself and a reverse circuit for the inverse of the function is chosen (see Lemma 1 for the explanation of the correctness of such operation).

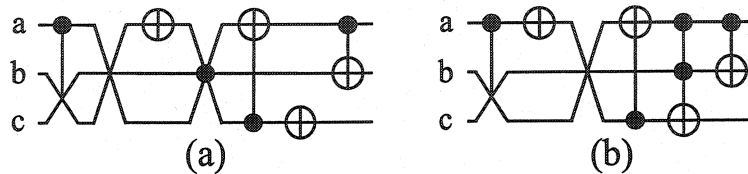

Figure 5.11: Simplified networks.

As the first test for our program, we apply the template tool to simplify the circuits from Fig. 5.3, which results in the circuits given in Fig. 5.11. It can be observed that the template application drops the cost of the first circuit from 12 to 7 and the cost of the second from 7 to 6. The produced circuits realize the same function, but one is smaller than the other. This happens because of the template application parameter restriction $k \geq \frac{m}{2}$. This way, a template application does not increase the number of gates in the circuit (which is much easier to program), but there may be cases when such a template application does not “notice” a better simplification, and this is the exact case. The first circuit of Fig. 5.11 can be transformed to the form of the second, if the template application parameter k is allowed to be less than half of the template size. The procedure which brings the first circuit to the form of the second is illustrated in Fig. 5.12. First, we apply template size 5 for 2 highlighted gates CNOT and NOT. This creates 2 NOTs followed by CNOT. Next, we match template size 6 and apply it for the parameter $k = 4$ (highlighted gates). This replaces the 4 gates with two: NOT and Fredkin. Next, we use the moving rule to pass NOT backwards through SWAP (highlighted gates). Finally, we use the Fredkin definition group with parameter $k = 2$ to bring the circuit to the form equivalent to shown in Fig. 5.11b.

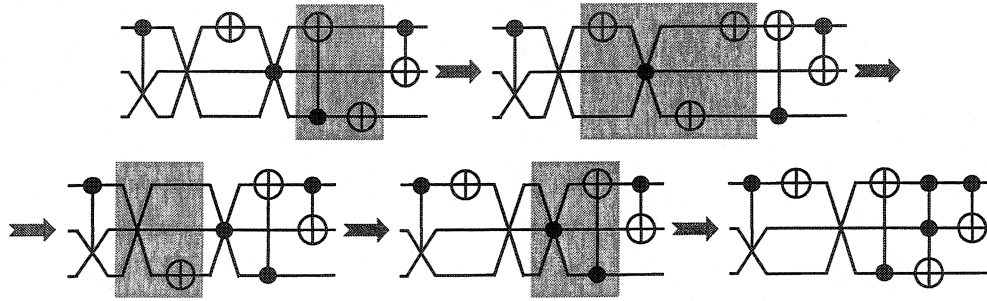

Figure 5.12: Simplifying one network into the other.

As a second experiment we ran our program exhaustively for all reversible functions of 3 variables and compared the results of our algorithm to the results of optimal synthesis. Table 5.4 shows how many functions of size 3 can be realized with $k = 0..10$ gates in optimal synthesis with the model gates NOT, CNOT, Toffoli, SWAP and Fredkin, optimal synthesis with the model gates NOT, CNOT and Toffoli (calculated in [74, 75]), optimal synthesis with the model gates NOT, CNOT, Toffoli and SWAP (calculated in [74, 75]), our previous results of the heuristic synthesis presented in [12] and for the presented algorithm realization. WA shows the weighted average of the circuit size of a three variable reversible function. Note that our algorithm produces the circuits which on average are 105.9% of the optimal size, which in comparison with the previous realization (111.5%) is almost twice as close to the optimal. The 105.9% difference from the optimal circuit allows us to say that our algorithm produces near optimal circuits for reversible functions of a small number of variables. Also note that even the heuristic synthesis of Toffoli/Fredkin networks (Algorithm column) produces a better weighted average than the synthesis of Toffoli networks (NCT column) only.

Size	Optimal	NCT	NCTS	CCECE	Algorithm
0	1	1	1	1	1
1	18	12	15	18	18
2	184	102	134	175	184
3	1318	625	844	1105	1290
4	6474	2780	3752	4437	5680
5	17695	8921	11194	10595	13209
6	14134	17049	17531	13606	13914
7	496	10253	6817	8419	5503
8	0	577	32	1877	512
9	0	0	0	86	9
10	0	0	0	1	0
WA:	5.134	5.866	5.629	5.724	5.437

Table 5.4: Results

5.6 Conclusion

The chapter starts with an observation that the usage of Fredkin gates is often beneficial. Thus, we generalized the algorithm from the previous chapter to use both Toffoli and Fredkin gates. When the circuit is created, the template tool is applied to simplify it. Again, templates based on the Toffoli gates give only a small part of the possible simplification. Therefore, templates with Toffoli and Fredkin gates were found, classified and applied. Note that the set of model gates is large, therefore a new definition of a class was chosen to keep the number of classes small and be able to unite similar templates

into one class. The results that we obtain for the heuristic synthesis of Toffoli-Fredkin family are competitive with other methods. They are only 105.9% higher than the optimal results for Toffoli-Fredkin synthesis and better than the optimal results for Toffoli synthesis (for number of variables $n = 3$).

Chapter 6

Asymptotically Optimal Regular Synthesis

The synthesis algorithm introduced in Chapter 3 was later transformed into an algorithm to synthesize Toffoli networks in Chapter 4, and modified one more time in Chapter 5 to use Fredkin gates. It is hard to recognize the old algorithm in it, but historically the Toffoli synthesis algorithm arrived as a modification of the theoretical synthesis algorithm for RCMG model. Further modification of this algorithm (an algorithm which will handle “don’t cares”) is under investigation. The Miller gate is known to have a cost of 7 in quantum technology, which is comparable to the costs of well-known Toffoli and Fredkin gates. It also happens that the Miller gate can be nicely used by the algorithm. The work on the incorporation of the Miller gate into the algorithm refers to my further research. In this chapter we develop another modification of the algorithm, which is asymptotically optimal (from the point of view of gate count).

To our best knowledge, not much has been done in regular reversible logic synthesis of a multiple output Boolean function. Authors of [45, 11, 51, 74, 75] suggest regular synthesis methods, but they usually produce large networks when applied as formulated and are not asymptotically optimal. Although asymptotic optimality does not mean

absolute minimality of the circuit produced by a method, the results of asymptotically minimal methods can be used to synthesize “hard” functions.

As an illustration of usefulness of the asymptotically optimal algorithms, note that throughout the history of computer circuit synthesis, examples of manufactured circuits with cost higher than the corresponding proven asymptotic upper bound was found.

Since the current versions of the algorithm work with Toffoli and Fredkin gates only and are not asymptotically optimal, a new set of gates for which the modification will be built are needed.

Definition 13. An **mEXOR gate** $TOF(C; T)$, where $C \cap T = \emptyset$ and $T = \{x_{j_1}, x_{j_2}, \dots, x_{j_m}\}$ is a single gate that is equivalent to the network $TOF(C; x_{j_1}) TOF(C; x_{j_2}) \dots TOF(C; x_{j_m})$.

We assume that the reversible cost of a single mEXOR gate is one. A pictorial representation of a mEXOR gate is shown in Figure 6.1. The notation does not reflect the actual structure of the gate, which is discussed in Section 6.1. In several sources (for example, [56, 67, 79]) a CNOT gate with multiple EXOR signs was used as a notation for a cascade of CNOTs with the same control and different targets. The gate that we propose in this section is a separate and general object. Its structure is analyzed in the following section.

6.1 Quantum Cost of the mEXOR gate

Quantum cost differs from the defined reversible cost, since it refers to how hard it is to realize a gate with an existing technology (in this case quantum). It would be interesting to analyze the quantum cost of the introduced gates in comparison to the

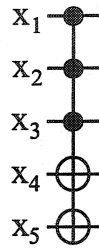

Figure 6.1: Example of a mEXOR Toffoli gate.

quantum cost of the known gates. We choose generalized Toffoli gates for the quantum cost comparison, since the introduced gates appear to be their natural generalization.

The problem of building quantum blocks to realize Toffoli gates was investigated by many authors. For the comparison of quantum cost of Toffoli and mEXOR Toffoli gates we will use results from [4]. For other implementations the costs can easily be recalculated.

Theorem 7. *The quantum cost for a mEXOR gate $TOF(C;T)$, $T = \{x_{j_1}, x_{j_2}, \dots, x_{j_m}\}$ is $|TOF(C, t)| + 2(m - 1)$, where $TOF(C, t)$ is a Toffoli gate with a single target.*

Proof. The picture in Figure 6.2 illustrates the construction of a circuit for $TOF(C, T)$ given a circuit for a generalized Toffoli gate, shown as a box. Sometimes, a Toffoli gate realization requires additional garbage bits to produce a smaller network. These bits are used in the box, but the initial states of the bits do not have to be set to 0 first, and the output on these bits is reset to the initial input values (as it is done in [4]). For example, the generalized Toffoli gate with 8 controls can be realized with cost 509 if no garbage bits are used, or with a cost of 172 elementary quantum operations if 4 garbage bits are allowed as shown in Table 6.1.

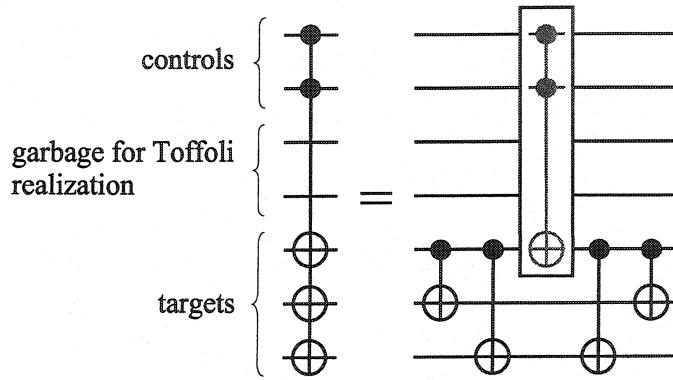

Figure 6.2: Construction of a single mEXOR gate.

The procedure of building an mEXOR gate $TOF(C, T)$ does not require any additional garbage bits and uses $2(m - 1)$ CNOT gates. The procedure also does not require the pre-setting of garbage bits and returns them unchanged (according to computations done in [4]). ■

Table 6.1 shows the cost comparison for Toffoli and mEXOR gates using the above theorem as a basis for the calculations. The quantum cost of Toffoli gates is calculated based on [4]. The absolute quantum complexities of Toffoli and 2-target, 4-target and 8-target mEXOR gates with the same number of controls are given in columns **Toffoli**, **2**, **4** and **8**. The relative values of mEXOR gate complexities with respect to the cost of the corresponding Toffoli gate are shown in columns **Rel 2**, **Rel 4** and **Rel 8**. The cost of mEXOR gates with zero or one control is m , since it can be implemented with m NOT or CNOT gates (each has a cost of one).

The following examples illustrate how Theorem 7 can be used to calculate the quantum costs of mEXOR gates.

Example 18. The mEXOR gate shown in Figure 6.1 has 3 controls and 2 targets. Thus,

#of controls	garbage	Toffoli	2	4	8	Rel 2	Rel 4	Rel 8
2	0	7	9	13	21	1.286	1.857	3
3	0	13	15	19	27	1.154	1.462	2.077
4	0	29	31	35	43	1.069	1.207	1.483
5	0	61	63	67	75	1.033	1.098	1.23
6	0	125	127	131	139	1.016	1.048	1.112
6	4	112	114	118	126	1.018	1.054	1.125
7	0	253	255	259	267	1.008	1.024	1.055
7	3	124	126	130	138	1.016	1.048	1.113
8	0	509	511	515	523	1.004	1.012	1.028
8	4	172	174	178	186	1.012	1.035	1.081

Table 6.1: Cost comparison.

its quantum cost is 15, which is approximately 1.154 of the cost of a Toffoli gate with the same number of controls. The straightforward realization of this mEXOR gate as a set of two Toffoli gates would have cost $2 * 13 = 26$, which is approximately 1.733 times higher than the cost in the suggested approach.

Example 19. The higher the number of controls, the more optimistic the results of the comparison. For an mEXOR gate with 10 controls and 10 targets its cost would be 286, which is approximately 1.067 of the cost of the corresponding Toffoli gate, and almost 10 (9.37) times better than the straightforward realization.

6.2 Asymptotically Optimal Reversible Synthesis Method

The organization of this section is as follows: we describe the reversible synthesis method, then define the Shannon function and prove that its lower boundary has the same cost order as the upper boundary for the cost of the algorithm. This allows us to say that the reversible synthesis algorithm is asymptotically optimal.

The following algorithm is very similar to the modifications discussed earlier. The idea is the usage of the Toffoli gate algorithm modification from the Chapter 4 where the Toffoli gates with the same set of controls are united to form one mEXOR gate.

Step 0. The top part of the left side of the truth table consists of the input pattern with the lowest order, $(0, 0, \dots, 0)$ which represents the integer 0 as a binary expression. The corresponding pattern in the output side, (b_1, b_2, \dots, b_n) does not necessarily consist of all zeros, therefore it must be brought to a form such that it is equal to the input part. To do so we use one mEXOR gate, $TOF(\emptyset; b_{i_1}, b_{i_2}, \dots, b_{i_k})$, where $\{b_{i_1}, b_{i_2}, \dots, b_{i_k}\} = \{b_j | b_j = 1, 1 \leq j \leq n\}$.

Step k. The input part of the truth table has the pattern (a_1, a_2, \dots, a_n) , which represents the binary expansion of the integer k . The output part has the pattern (b_1, b_2, \dots, b_n) which, in general, differs from (a_1, a_2, \dots, a_n) . For any Boolean pattern (x_1, x_2, \dots, x_n) we define the set $X^1 = \{x_j | x_j = 1, 1 \leq j \leq n\}$, a pattern consisting of all 1-bits of (x_1, x_2, \dots, x_n) . In order to bring (b_1, b_2, \dots, b_n) to the form (a_1, a_2, \dots, a_n) , we need at most two mEXOR gates:

1. **Increase ones.** We apply mEXOR gate $TOF(B^1; A^1 \setminus B^1)$ to bring (b_1, b_2, \dots, b_n)

to the form $(c_1, c_2, \dots, c_n) = (a_1 \vee b_1, a_2 \vee b_2, \dots, a_n \vee b_n)$; we change the output part of the truth table as dictated by the gate.

2. **Decrease ones.** We apply mEXOR gate $TOF(A^1; C^1 \setminus A^1)$ to bring (c_1, c_2, \dots, c_n) to the form (a_1, a_2, \dots, a_n) ; we change the output part of the truth table as dictated by the gate.

Note that during this step all the patterns previously put at their places were not altered:

- $(b_1, b_2, \dots, b_n) \succeq (a_1, a_2, \dots, a_n)$ since all the patterns in the order less than (a_1, a_2, \dots, a_n) are already at their correct places in the upper part of the truth table.
- It follows from the definition of (c_1, c_2, \dots, c_n) , $(c_1, c_2, \dots, c_n) \succeq (b_1, b_2, \dots, b_n) \succeq (a_1, a_2, \dots, a_n) \Rightarrow (c_1, c_2, \dots, c_n) \succeq (a_1, a_2, \dots, a_n)$.

Step $2^n - 1$. Actually, there are no operations at the last step, since if all of the $2^n - 1$ patterns with lower order are on their places, there is automatically only one spot available for the last pattern, $(1, 1, \dots, 1)$.

Complexity analysis. An upper bound on the complexity of the presented algorithm's output is given by the formula $2^{n+1} - 4$. Since there are 2^n steps, and each requires at most 2 gates to be added to the network, the total cost is $2 * 2^n$. A more accurate analysis shows that the first step adds at most one gate, the last step never adds a gate, and the step before last uses at most one gate (similarly to what we had in the first step), therefore the complexity decreases to $2^{n+1} - 4$. This bound is reachable, so it cannot be any smaller.

Example 20. We take a reversible function given as a truth table (columns **Input** and **Output** of the Table 6.2) with the variables named x_1, x_2, x_3 , and x_4 . Its output is the

input with permuted pattern 0011 and 1100.

The algorithm proceeds as follows:

- **Steps 0-2.** Since the patterns match, we do nothing.
- **Step 3.** Input pattern 0011 does not match output pattern 1100.
 - Increase ones. We apply mEXOR gate $TOF(x_1, x_2; x_3, x_4)$ to bring pattern 1100 to the form 1111. The result is shown in column 3I.
 - Decrease ones. We apply mEXOR gate $TOF(x_3, x_4; x_1, x_2)$ to bring pattern 1111 to the desired form of 0011. The result is shown in column 3D.
- **Steps 4-6.** We do nothing, since everything matches.
- **Step 7.** Pattern 1011 does not match the desired 0111.
 - Increase ones. We apply mEXOR gate $TOF(x_1, x_3, x_4; x_2)$. The result is shown in 7I.
 - Decrease ones. We apply mEXOR gate $TOF(x_2, x_3, x_4; x_1)$; see column 7D.
- **Step 11.** 1111 does not match the desired 1011. We decrease the ones by applying $TOF(x_1, x_3, x_4; x_2)$. The result of operation is shown in 11D.
- **Step 12.** Finally, we match the last pattern by applying mEXOR gate $TOF(x_1, x_2; x_3, x_4)$.

The 6 gates obtained above are shown as a network in Figure 6.3. Note that the gates are in reverse order.

In quantum technology the cost of Toffoli and mEXOR gates grows quadratically with the number of controls when no garbage is allowed, and linearly as $48n - 212 (n \geq 7)$ if a

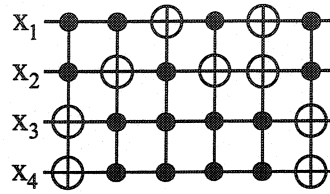

Figure 6.3: mEXOR gate network.

certain amount of garbage is permitted [4]. It is clearly beneficial to have fewer controls. In the following we provide a modification of the algorithm which favors smaller gates.

Quantum modification. We update the “increase ones” step as follows. We apply mEXOR gate $TOF(D^1; B^1 \setminus A^1)$ to bring (b_1, b_2, \dots, b_n) to the form $(c_1, c_2, \dots, c_n) = (a_1 \vee b_1, a_2 \vee b_2, \dots, a_n \vee b_n)$. Where the set D^1 is defined as follows: $D = \min\{D = (d_1, d_2, \dots, d_n) \mid D^1 \subseteq B^1, (d_1, d_2, \dots, d_n) \succeq (a_1, a_2, \dots, a_n)\}$.

The above simplification procedure allows us to choose a smaller gate for the “increase ones” step. Although it does not necessarily mean that the cost of the network will decrease, it may decrease if the operation is used wisely. Some other modifications of the algorithm, when not necessarily minimal subsets D are chosen, may lead to a simpler network, but it is hard to specify which set D to choose. Exhaustive search is almost impossible, since the branching factor will be too high, so we propose a heuristics approach for further modifications.

We illustrate the algorithm and its quantum modification with an example where the usage of quantum modification is beneficial. Examples where it will not be beneficial also exist. We take the function specified by the truth table in **Input-Output** columns, with the names of variables a, b, c written left-to-right (see Table 6.3).

For the basic approach, we find the first pattern of the output part of the truth table which differs from the corresponding input pattern. It is 101. We increase the ones by applying $TOF(a, c; b)$ (result is shown in column **BI**), so the pattern becomes 111. We next decrease the ones by applying $TOF(b, c; a)$ and update the information (column **BD1**). Finally, we decrease the ones of 111 to the desired input pattern 011 by applying $TOF(a, c; b)$.

For the quantum modification, we select the smaller gate (first step), $TOF(a; b)$, to increase the ones of 101 (column **QI**). At the second step we decrease the ones of 111 by applying $TOF(b, c; a)$ (result is shown in **QD1** column). Finally, we use $TOF(a; b)$ to decrease the ones of 110 to match input pattern 100.

Quantum cost analysis: the basic approach uses 3 Toffoli gates, which results in the total cost of 21, whereas the quantum modification has cost 9.

Note that the function given in the above example can be realized with one gate, namely the Fredkin gate.

Definition 14. The **Shannon function** $L(n)$ is the maximal number of gates required to realize a reversible function of n variables with an optimal network.

We have just proved an upper bound $L(n) \leq 2^{n+1} - 4$, which is $L(n) \in O(2^n)$. We next prove a lower bound $L(n) \geq C * 2^n$ for a positive constant C .

Lemma 13. The number of distinct mEXOR gates with n variables is $(3^n - 2^n)$.

Proof. Each of the variables may participate in a gate as a control or target, or may

not be a part of a gate. This gives the possibility of 3^n gates. However, among those 3^n some will not contain any target bits, and therefore will not be a mEXOR gate. The number of these last will be 2^n (each bit is allowed to be either in control or is not present). Thus, the answer is given by the formula $(3^n - 2^n)$. ■

It is interesting to note that an mEXOR gate with zero controls is used at most once in the algorithm (Step 0), but the number of them is exponential, namely 2^n . It happens that considering these gates as a set of NOTs does not lead to a change of asymptotic behavior, which is the focus of this section.

Theorem 8. $L(n) \geq \frac{2^n}{\ln 3} + o(2^n)$.

Proof. The number of all reversible functions of n variables is $2^n!$ (as the number of permutations of 2^n elements). The total number of mEXOR gates is $3^n - 2^n$. Supposing that by taking all the possible cascades of mEXOR gates we get different functions (which is, of course, not true), the complexity of the hardest to realize function is given by the formula $\log_{(3^n - 2^n)}(2^n!)$. Since some cascades built during such process will give equal functions, the expression $\log_{(3^n - 2^n)}(2^n!)$ gives a lower bound for the cost of the most expensive to build reversible function. This expression can be simplified using Stirling's formula to the form $\frac{2^n}{\ln 3} + o(2^n)$. ■

6.3 Conclusion

In this chapter the first asymptotically optimal algorithm in reversible logic synthesis theory was presented. The results of this section are mostly theoretical, although they may be used in applications. This is the first (in literature) result on asymptotic

optimality of the gate count in a reversible synthesis procedure.

Input	Output	3I	3D	7I	7D	11D	12D
0000	0000	0000	0000	0000	0000	0000	0000
0001	0001	0001	0001	0001	0001	0001	0001
0010	0010	0010	0010	0010	0010	0010	0010
0011	1100	1111	0011	0011	0011	0011	0011
0100	0100	0100	0100	0100	0100	0100	0100
0101	0101	0101	0101	0101	0101	0101	0101
0110	0110	0110	0110	0110	0110	0110	0110
0111	0111	0111	1011	1111	0111	0111	0111
1000	1000	1000	1000	1000	1000	1000	1000
1001	1001	1001	1001	1001	1001	1001	1001
1010	1010	1010	1010	1010	1010	1010	1010
1011	1011	1011	0111	0111	1111	1011	1011
1100	0011	0011	1111	1011	1011	1111	1100
1101	1101	1110	1110	1110	1110	1110	1101
1110	1110	1101	1101	1101	1101	1101	1110
1111	1111	1100	1100	1100	1100	1100	1111

Table 6.2: Circuit building process for a four variable function.

Input	Output	BI	BD1	BD2	Input	Output	QI	QD1	QD2
000	000	000	000	000	000	000	000	000	000
001	001	001	001	001	001	001	001	001	001
010	010	010	010	010	010	010	010	010	010
011	101	111	011	011	011	101	111	011	011
100	100	100	100	100	100	100	110	110	100
101	011	011	111	101	101	011	011	111	101
110	110	110	110	110	110	110	100	100	110
111	111	101	101	111	111	111	101	101	111

Table 6.3: Circuit for the basic approach.

Chapter 7

Dynamic Programming Algorithms as Reversible Circuits: Symmetric Function Realization

In this chapter we give a general idea of how to realize a dynamic programming algorithm as a reversible circuit. This realization is not tied to a specific reversible design model and technology or a class of dynamic algorithms; it shows an approach for such synthesis. As an illustration of this approach, a class of all symmetric functions is realized in a dynamic programming algorithm manner as a reversible circuit of Toffoli elements. The garbage, quantum and reversible costs of the presented implementation are calculated and compared to the costs of previously described reversible synthesis methods (both the reversible synthesis methods presented in this thesis, as well as those presented in works of other authors).

General recursion and dynamic programming algorithms [9, 17, 19] form a very important class of algorithms. Many real-world problems can be solved by dynamic programming algorithms: finding a value for a symmetric function, algorithms on strings, and most approximation methods.

The main idea of a dynamic programming algorithm is the recursive decomposition of

the problem f into a set of other problems, where the answer for f can be found in terms of a “simple” operation on the answers of subproblems. When the dynamic algorithm is completely specified, a set of operations needed to make a step of the calculation, and a set of subfunctions needed for the computation is defined. Further, to build a reversible circuit we will realize each of the algorithm operations as a reversible cascade. But first, we need to find the garbage cost of the implementation.

Given a problem (function) f with Boolean inputs (x_1, x_2, \dots, x_n) and a dynamic algorithm that terminates after S steps of calculation, we first calculate the two numbers:

- $M = \max_{s=1..S}(m_s)$, where m_s is the number of Boolean values (intermediate storage) needed in addition to the input values in order to complete the calculation starting at step s . That is, M represents the maximum number of subfunction values which are needed in order to complete the algorithm calculation starting from step s . For simplicity assume that on each step of the algorithm only one subfunction value is updated.
- Given a reversible design model and the set of all operations the dynamic algorithm performs at one step, we find the number $G = \max_{s=1..S}(g_s)$, where g_s is the minimal amount of garbage needed for the reversible implementation of the s -th step of the algorithm in terms of the considered model.

When the two numbers are determined, the circuit is constructed as follows:

- We create the set of input constants size $M + G$ and assign zero values to all of them. M will be used to store intermediate results of the calculation and the answer itself, and the G values are needed for the calculation.

- We use the reversible design model to create a circuit for each of the S steps of the specified dynamic programming algorithm. The circuit changes one subfunction value at a time.

When the circuit is built, the outputs which contain the answer are specified by the dynamic algorithm.

The amount of the resulting reversible design garbage, as well as the final cost of the network will depend on the design of the dynamic programming algorithm and strength of the reversible design model.

Note that a benefit of using this method comes from the following consideration. If a multiple output function to be realized has outputs for which the dynamic programming algorithm is known and those for which the dynamic programming algorithm is not known, the dynamic programming realizable outputs can be built first by the suggested method. The resulting circuit passes the input values through unchanged. Therefore, the remaining outputs can be built by any other procedure without any special preprocessing.

7.1 Application: Multiple Output Symmetric Functions

To run the application, we need reversible logic gates (design model), a synthesis model, and the dynamic programming algorithm. We define the model by taking the most popular of reversible logic gates: $TOF(a)$, $TOF(a; b)$, and $TOF(a, b; c)$. The set of these gates was shown to be complete. This is a minimally complete set of gates in the sense that excluding any one from this set will result in incompleteness if no garbage

addition is allowed. We do not choose any specific design procedure as it will be showed that the implementation of a single step of the dynamic programming algorithm is very simple.

To design a dynamic programming algorithm we need several definitions.

Definition 15. Multiple output symmetric Boolean function $\vec{F}(x_1, x_2, \dots, x_n) = (y_1, y_2, \dots, y_m)$ is such a function that $\vec{F}(x_1, x_2, \dots, x_n) = \vec{F}(\pi(x_1, x_2, \dots, x_n))$, where π is a permutation of n elements.

Definition 16. The σ -function $\sigma_n^k(x_1, x_2, \dots, x_n)$ is defined as $\bigoplus_{\{i_1 < i_2 < \dots < i_k\}} x_{i_1} x_{i_2} \dots x_{i_k}$ for $k = 0, 1, \dots, n$.

Lemma 14. Every symmetric function can be written as a linear combination (with respect to operation EXOR) of not more than $(n + 1)$ σ -functions.

Proof. There are $(n + 1)$ different σ -functions; all are linearly independent. In fact, their kernels (set of inputs such that for each input the function is not equal to zero) do not intersect, thus different linear combinations produce different functions. All σ -functions are symmetric, and so are their linear combinations. The number of symmetric functions of n variables is 2^{n+1} , therefore the different linear combinations of σ -functions form the set of all symmetric functions and each symmetric function has a unique linear form made of σ -functions. ■

Lemma 15. $\sigma_n^k(x_1, x_2, \dots, x_n) = x_n \sigma_{n-1}^{k-1}(x_1, x_2, \dots, x_{n-1}) \oplus \sigma_{n-1}^k(x_1, x_2, \dots, x_{n-1})$ for $k \geq 2$.

Proof. Observe that the first part of the right hand side has all the terms of degree k which include variable x_n as a multiple, while the second part has all the terms of degree k which do not include the variable x_n . Thus, the right hand side has all the terms of degree k , which, by definition, forms the left hand side. ■

Note that the statement of Lemma 15 holds for $k = 1$. The result for $k = 1$ will be used to calculate $\sigma_n^1(x_1, x_2, \dots, x_n)$. Use Lemma 15 to form the dynamic programming algorithm for calculating a symmetric function by saying that in order to build a multiple output symmetric function, we first build the set of σ -functions recursively and then construct the output vector as a linear combination of the outputs of dynamic programming algorithm. Formally the algorithm works as follows:

1. create Boolean array $\text{sigma}[1..n]=0$;
2. for $i=1$ to n
3. for $k=i$ down to 1
4. if $k>1$ $\text{sigma}[k] = (\text{sigma}[k] + x[i]*\text{sigma}[k-1]) \bmod 2$;
5. if $k=1$ $\text{sigma}[k] = (\text{sigma}[k] + x[i]) \bmod 2$;
6. end for;
7. end for.

We define the two numbers needed for calculation and build the circuit:

- In order to calculate $\sigma_b^a(x_1, x_2, \dots, x_b)$ we need $\sigma_{b-1}^{a-1}(x_1, x_2, \dots, x_{b-1})$ and $\sigma_{b-1}^a(x_1, x_2, \dots, x_{b-1})$, and in order to continue and complete the calculations we will need $\sigma_{b-1}^{a-1}(x_1, x_2, \dots, x_{b-1})$, $\sigma_{b-1}^{a-2}(x_1, x_2, \dots, x_{b-1}), \dots, \sigma_{b-1}^1(x_1, x_2, \dots, x_{b-1})$. If $a = 1$, we use the formula $\sigma_b^1(x_1, x_2, \dots, x_b) = \sigma_{b-1}^1(x_1, x_2, \dots, x_{b-1}) \oplus x_b$. For $a = 0$ we do not create anything, since the addition

of a unit can be done in-place when the outputs are created by a single NOT gate.

Therefore, $M = \max_{b=1,2,\dots,n}(b) = n$.

- For the intermediate calculations no garbage is needed, $G=0$. To calculate function $\sigma_b^1(x_1, x_2, \dots, x_b)$ we use the gate $TOF(x_b; \sigma_{b-1}^1(x_1, x_2, \dots, x_{b-1}))$ at line 4 of the pseudocode. The function $\sigma_{b-1}^1(x_1, x_2, \dots, x_{b-1})$ will not be used in further calculations, so we can overwrite it. To calculate $\sigma_b^a(x_1, x_2, \dots, x_b)$, we use the gate $TOF(x_b, \sigma_{b-1}^a(x_1, x_2, \dots, x_{b-1}); \sigma_{b-1}^{a-1}(x_1, x_2, \dots, x_{b-1}))$ at line 5 of the pseudocode. Again, the function $\sigma_{b-1}^{a-1}(x_1, x_2, \dots, x_{b-1})$ will not be used in further calculations, so we can overwrite it.

When the dynamic programming part creates the set of outputs $\sigma_n^k(x_1, x_2, \dots, x_n)$ for $k = 1, 2, \dots, n$, we construct the output by including the needed σ -functions. Depending on what the function is, we may or may not need to create the additional garbage outputs. A greedy method may create m additional zero constants for the outputs. In practice, a better solution is usually possible. The described synthesis algorithm allows to formulate the following result.

Theorem 9. *Every symmetric multiple output function $\vec{F}(x_1, x_2, \dots, x_n) = (y_1, y_2, \dots, y_m)$ can be realized with the cost of:*

- *at most m NOT gates, at most $n + mn$ CNOT gates, and $\frac{n(n-1)}{2}$ Toffoli gates;*
- *garbage of at most $2n$ bits.*

Less garbage can be achieved if we notice that there is no need to create a special constant line for $\sigma_b^1(x_1, x_2, \dots, x_b)$, which can be stored on the input line x_b . This allows us to

decrease both garbage and reversible implementation costs by 1. Other garbage and cost saving comes from the observation that if all the outputs can be composed of the first $k + 1$ ($2 \leq k \leq n$) σ -functions $\sigma_n^0(x_1, x_2, \dots, x_n), \sigma_n^1(x_1, x_2, \dots, x_n), \dots, \sigma_n^k(x_1, x_2, \dots, x_n)$, we do not need to run the dynamic programming algorithm to create the remaining $(n - k)$ σ -functions. These two observations allow us to formulate the following result:

Theorem 10. *Every symmetric multiple output function $\vec{F}(x_1, x_2, \dots, x_n) = (y_1, y_2, \dots, y_m)$, where a linear σ -function decomposition requires a function of maximal degree k ($2 \leq k \leq n$) can be realized with the cost of:*

- *at most m NOT gates, at most $n + mn - 1$ CNOT gates, and $\frac{(2n-k)(k-1)}{2}$ Toffoli gates;*
- *garbage of at most $n + k - 1$ bits.*

Another benefit of using this method comes from the following consideration. If a multiple output function to be realized has both symmetric and non symmetric outputs, the symmetric outputs can be realized first by the suggested method. Then, the set of gates $TOF(x_{n-1}; x_n) TOF(x_{n-2}; x_{n-1}) \dots TOF(x_2; x_1)$ is applied to the end of the cascade, which creates the whole set of unchanged inputs $\{x_1, x_2, \dots, x_n\}$ on the first n output lines of the cascade. Therefore, the remaining outputs can be built by any other procedure. Such an operation adds $(n - 1)$ gates to the cascade. If for the target technology the cost of a single garbage bit is less than the cost of $(n - 2)$ CNOT gates, the very first approach when a special line is created for $\sigma_1(x_1, x_2, \dots, x_n)$ can be used.

Example 21. Take a multiple output function *rd53.pla*, which is the 5-input 3-output symmetric function whose output is the binary representation of the number of ones in

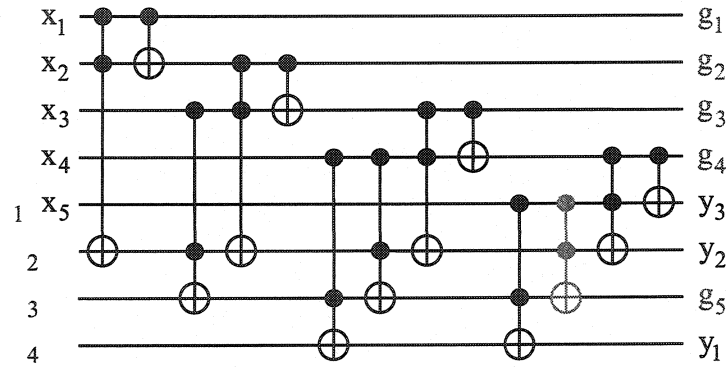

Figure 7.1: Circuit for *rd53*

its input. First, find its σ -representation $(\sigma^4, \sigma^2, \sigma^1)$. Notice, that σ^5 -function must not be built. Build the dynamic programming part. Observe, that the gates which affect a garbage bit whose changed value is not used by the design afterwards (the gate colored gray in Fig 7.1) can be deleted from the circuit without changing the output of the target function. The resulting circuit will contain 12 gates only.

In all of our further designs, if a gate affects a garbage bit whose changed value is not used by the circuit to affect output bits afterwards, it is deleted from the design. This trivial procedure brings some simplification in almost every case.

The reversible Toffoli, CNOT and NOT gates can be implemented in quantum technology with the costs 5, 1 and 1 respectively. Note, that the quantum cost of any sequence of type $TOF(a, b; c) TOF(a; b)$ (4 of those in the present circuit) is 4 [62], an implementation which was known to Peres [57], and its cost is one smaller than the quantum cost of a single Toffoli gate (which is 5). Peres structure as a gate was not considered separately in the literature, although it is clearly beneficial to do so.

These observations allow us to create the formula for the quantum cost of the method.

It can be easily shown that the quantum complexity of a symmetric multiple output function $\vec{F}(x_1, x_2, \dots, x_n) = (y_1, y_2, \dots, y_m)$ requiring σ -functions of maximal order k is at most

$$m + n + mn - 1 + \frac{5(2n - k)(k - 1)}{2} - 2(n - 1) = mn + m - n + 1 + \frac{5(2n - k)(k - 1)}{2}.$$

7.2 Comparison of the Results

There were several design methods proposed in the literature for the reversible design of multiple output Boolean functions. We would like to compare our results to the results of RPGA method by Perkowski *et al.* [60] (the method designed to synthesize the symmetric functions with reversible gates), reversible wave cascades [54], Khan gate family synthesis [28],[27], generalized Toffoli gates family (from Chapter 3) and design of the Toffoli circuits using the templates (from Chapter 4). The comparison consists essentially of the three parts: comparison of the garbage, number of gates in the reversible cascade and comparison of the quantum costs.

Unfortunately, [60] do not provide a table of results, which makes it hard to make the precise comparison. The asymptotic reversible cost (number of gates) of the both realizations are the same, namely $O(n^2)$. But, the RPGA method has excessive garbage, $\frac{n(n+1)}{2}$ (calculated in [45]), when the presented method has the garbage of maximum $(2n - 1)$. A good quantum realization of the Kerntopf gates used in [60] was never found, therefore we claim that from the point of view of quantum cost our method will produce quantum circuits which will be constant (> 1) times cheaper. Comparison to the reversible wave cascades [54] (RWC columns), Khan gate family synthesis [28]

function			number of gates				garbage			
name	in	out	RWC	KGF	GT	We	RWC	KGF	GT	We
2of5	5	1	N/A	N/A	7	12	N/A	N/A	5	6
rd53	5	3	14	17	13	12	19	19	4	5
rd73	7	3	36	43	37	20	43	47	6	7
rd84	8	4	58	64	N/A	28	66	68	7	11
6sym	6	1	N/A	N/A	13	20	N/A	N/A	6	9
9sym	9	1	52	52	N/A	28	61	60	9	11
xor5	5	1	5	5	4	4	10	9	4	4

Table 7.1: Comparison of the results to RWC, KGF and GT

(KGF columns) and generalized Toffoli gates family [45],[11] (GT columns) reversible synthesis results is summarized in Table 7.1. Actual circuits for the presented design can be found in the Internet [44].

The presented comparison is not quite fair. From one side, the mentioned methods are the general synthesis methods, which do not use special properties of functions such as ability to be calculated as a dynamic programming algorithm. From the other side, the cardinality of the set of gates of the mentioned methods is greater on the order than the number of gates used by the presented method.

From the table it can be seen that our method starts producing better results for larger functions both from the point of view of the reversible cost and garbage. The presented method can never beat the generalized Toffoli gates family synthesis method in terms of

garbage, since the last has theoretically minimal garbage. But, the GT method scales badly, it can produce the circuits for reversible functions with no more than 10 inputs. The RWC and KGF are synthesized heuristically and they also scale much worse than the presented method.

Quantum cost comparison can be done accurately but in this paper we just mention that the quantum cost of RWC is at least n times reversible design cost, quantum cost of KGF implementation is at least $2n$ times higher than its reversible cost and quantum cost of GT is at least n times higher than its reversible cost, where n is the number of inputs of a function. The quantum cost for our model is given in previous section, and it cannot exceed 5 times the reversible cost. Clearly, the quantum cost of the presented approach is much better.

To illustrate how good the quantum cost is, compare the results to the ones presented in Chapter 4. This chapter provides an example of a circuit for *rd53.pla* function which has a cost of 12 gates, which seem to be the best among all known in reversible logic synthesis. The generalized Toffoli gates used in Chapter 4 are expensive (but no more expensive than the gates in RWC, KGF and GT) and the quantum complexity calculation based on results of [4] gives the quantum cost of 132 for that realization. Although the realization of *rd53.pla* presented in this paper has 12 gates in the reversible model, its quantum cost is only 36. Relation of the quantum costs 11:3 clearly shows the benefits of using the dynamic algorithm reversible synthesis method even for small functions. Since our method produces better results for larger functions, the quantum cost comparison for them will be even more beneficial.

Another interesting comparison can be made using *2of5.pla* function. GT realization claims 7 gates only in comparison to 12 in the presented paper. However, the quantum cost of GT realization is 158 in comparison to 32 for our circuit with 12 gates.

7.3 Conclusion

In this chapter we presented a general approach to the synthesis of reversible circuits for the dynamic programming problems. As an illustration of its efficiency we applied it to the set of all multiple output symmetric functions and analyzed the three cost factors: reversible model cost, garbage cost and quantum cost. We showed that almost in every possible comparison our method produces better results (except for garbage comparison with RCMG and Toffoli synthesis). The garbage in the presented method is close to the theoretical minimum. The quantum cost of the circuits produced by the new algorithm is always significantly better. Finally, due to the small size of the gates used (maximum 3 inputs and 3 outputs), the levels of the network can be compressed which will result in a further simplification. On the contrary, it is unlikely that the level compression operation will give good results for models that use large gates.

Chapter 8

Summary

The thesis starts with analysis of garbage in existing reversible design models. My first point is that excessive amounts of garbage are introduced by existing synthesis approaches. Given that garbage is very expensive for some of the technologies that use reversibility, a question arises: is it possible to synthesize functions with less garbage (if not absolutely minimal) using gates of a reasonable technological cost and with relatively small circuits? Chapter 3 provides a complete answer to this question. A new structure, initially intended for reversible synthesis with theoretically minimal garbage was created and the synthesis algorithm was developed. The cost of a single gate was analyzed, and shown to be only marginally higher than the cost of the conventional Toffoli gate. The heuristic synthesis of a new model produces results comparable to the synthesis of other reversible circuits. The new RCMG model was shown to be superior to the conventional non-reversible synthesis of EXOR PLAs both practically and theoretically. The practical part has circuits for `rd53.pla` and a 3-bit full adder that are smaller than the corresponding EXOR PLA realizations. The theoretical part consists of two results. First, given an EXOR PLA, the RCMG circuit with the number of gates equal to the number of terms of EXOR PLA was constructed. Second, a class of exponentially hard to realize as EXOR PLAs functions was found. These functions

can be realized with only a linear gate count (cost) by the RCMG model. Also, if the technology allows compressing of levels, the cost becomes a constant(!).

Next, I tried a different approach, where a circuit is initially created by a regular synthesis algorithm, and the created circuit is usually smaller than the one created by the RCMG regular synthesis algorithm. Then, a template simplification tool was applied. In this approach only Toffoli and Fredkin gates were used as the gates for which a good implementation was found. In comparison to the results of RCMG synthesis I obtained better circuits for the new reversible specifications. For small reversible functions our algorithm behaves close to optimal by producing circuits that are only 105.9% more expensive than the optimal. Unfortunately, the new method does not handle “don’t cares”. Currently, we are working on handling “don’t cares”, extending the set of model gates and polishing up the template tool.

An interesting theoretical result would be an asymptotically optimal synthesis method. Such a method was found, and the model gates for the synthesis of this method were shown to be only marginally higher than the cost of Toffoli gates.

Finally, dynamic programming algorithms were realized in a reversible manner. Since the set of all dynamic programming algorithms is complex, this section has only a theoretical method for a general solution. As an application I considered the class of all multiple output symmetric functions, elements of which were shown to be dynamic programming algorithms. This class was realized in a reversible manner and the results of the circuit cost comparison to other synthesis methods showed that even a straightforward application of the theoretical algorithm produces the best known circuits.

Chapter 9

Further Research

Results of the presented thesis form the basis for further research. Currently, several topics need more investigation.

1. The template tool can be applied to simplify the structure of an RCMG network. Essentially, an RCMG gate is a Toffoli gate, for which a search of the templates was done in Chapter 4. The results of this chapter can be taken as a start of the search for more generalized templates. The same idea (a template simplification tool) can be generalized to simplify the mEXOR gate network, as well as the hybrid RCMG-mEXOR model.
2. In quantum technology there are essentially quantum gates, such as X (analogy of Boolean NOT), Z and Hadamard gate, whose specification cannot be considered from the point of view of Boolean logic only. However, these gates have the property needed to use them in templates: they are all self-inverses. Rotation gates are among the quantum gates that are not self inverses. However, they can be incorporated into the template structure by generalizing the template as follows (to be generalized). The **generalized template of size m** is the cascade of gates $G_0 G_1 \dots G_{m-1}$ which realizes the identity function. Any template of size

m should be independent of smaller size templates, *i.e.* application of smaller size templates does not decrease the number of gates in a size m template. Given a template $G_0 G_1 \dots G_{m-1}$, its application for parameter k such that $m/2 \leq k \leq m$ and any i such that $0 \leq i \leq m$ is:

$$G_i G_{(i+1) \bmod m} \dots G_{(i+k-1) \bmod m} \rightarrow G_{(i-1) \bmod m} G_{(i-2) \bmod m} \dots G_{(i+k) \bmod m}$$

Such a template tool will allow simplification of any quantum network.

3. The synthesis algorithms in Chapters 4, 5, 6 do not use a look-ahead technique to produce initially smaller circuits. It would be useful to investigate this modification. One more modification is a one-directional synthesis with “don’t cares”. It should be relatively easy to describe and test such an algorithm.
 4. The Miller gate can be easily and naturally incorporated into the synthesis algorithm of Chapter 5. The problems with the Miller gate will appear when new templates will be needed; the new template classification may be harder.
-
5. The dynamic programming algorithm reversible circuits were built only for symmetric functions. It is worth looking at other important dynamic algorithms and try to realize them as reversible circuits. The resulting circuits for this approach are expected to scale well and be small due to their use of information on the general structure of the target function.
 6. Expansion of the table of optimal circuits for functions of 4 variables. This cannot be done in a straightforward manner, a classification of reversible functions is required. Some other reductions should also be investigated. This may initially sound a bit strange, as why would one be interested in all optimal size 4 reversible

functions from the point of view of possible applications? However, in addition to a better understanding of reversible logic, this work will produce some applicable results. For instance, cellular arrays require synthesis of size 4 reversible functions only.

7. Synthesis procedures based on the truth table are limited to functions of, say, 30 inputs (if usage of modern computers for CAD is expected). Thus, a new design procedures needed. It may be useful to search for synthesis procedures based on the function factorization and theory of the group of permutations.

Bibliography

- [1] IBM's test-tube quantum computer makes history. Technical report, http://researchweb.watson.ibm.com/resources/news/20011219_quantum.shtml, Dec. 2001.
- [2] A. Al-Rabadi. *Novel Methods for Reversible Logic Synthesis and Their Application to Quantum Computing*. PhD thesis, Portland State University, Portland, Oregon, USA, October 2002.
- [3] W. C. Athas and L. J. Svensson. Reversible logic issues in adiabatic CMOS.
- [4] A. Barenco, C. H. Bennett, R. Cleve, D. P. DiVincenzo, N. Margolus, P. Shor, T. Sleator, J. A. Smolin, and H. Weinfurter. Elementary gates for quantum computation. *The American Physical Society*, 52:3457–3467, 1995.
- [5] C. H. Bennett. Logical reversibility of computation. *IBM J. Research and Development*, 17:525–532, November 1973.
- [6] C. H. Bennett. Notes on the history of reversible computation. *IBM J. Research and Development*, 32(1):16–23, January 1988.

- [7] D. Brand and T. Sasao. Minimization of AND-EXOR expressions using rewriting rules. *IEEE Transactions on Computers*, 42(5):568–576, May 1993.
- [8] J. W. Bruce, M. A. Thornton, L. Shivakumaraiah, P. S. Kokate, and X. Li. Efficient adder circuits based on a conservative reversible logic gate. In *IEEE Symposium on VLSI*, pages 83–88, April 2002.
- [9] T. H. Cormen, C. E. Leiserson, and R. L. Rivest. *Introduction to Algorithms*. The MIT Press, Cambridge, Massachusetts, 1990.
- [10] B. Desoete, A. De Vos, M. Sibinski, and T. Widderski. Feynman's reversible gates implemented in silicon. In *6th International Conference MIXDES*, pages 496–502, 1999.

Bibliography

- [11] G. W. Dueck and D. Maslov. Reversible function synthesis with minimum garbage outputs. In *6th International Symposium on Representations and Methodology of Future Computing Technologies*, pages 154–161, March 2003.
- [12] G. W. Dueck, D. Maslov, and D. M. Miller. Transformation-based synthesis of networks of Toffoli/Fredkin gates. In *IEEE Canadian Conference on Electrical and Computer Engineering*, Montreal, Canada, May 2003.
- [13] R. Feynman. Quantum mechanical computers. *Optic News*, 11:11–20, 1985.
- [14] E. Fredkin and T. Toffoli. Conservative logic. *International Journal of Theoretical Physics*, 21:219–253, 1982.
- [15] A. Gaidukov. Algorithm to derive minimum ESOP for 6-variable function. In *5th International Workshop on Boolean Problems*, pages 141–148, September 2002.
- [16] N. Gershenfeld and I. L. Chuang. Quantum computing with molecules. *Scientific American*, June 1998.
- [17] M. T. Goodrich and R. Tamassia. *Algorithm Design: foundations, analysis, and Internet Examples*. John Wiley & Sons, Inc., 2002.
- [18] G. Hinton, D. Sager, M. Upton, D. Boggs, D. Carmean, A. Kyker, and P. Rousel. The microarchitecture of the Pentium 4 processor. Technical report, Intel Technology Journal, 2001.
- [19] E. Horowitz, S. Sahni, and S. Rajasekaran. *Computer Algorithms/C++*. Computer Science Press, 1998.
- [20] Richard J. Hughes. A technology roadmap for quantum computing and communications. In *DAC*, <http://qist.lanl.gov/>, June 2003.
- [21] S. L. Hurst, D. M. Miller, and J. C. Muzio. *Spectral Techniques in Digital Logic*. Academic Press, Orlando, Florida, 1985.
- [22] K. Iwama, Y. Kambayashi, and S. Yamashita. Transformation rules for designing CNOT-based quantum circuits. In *Design Automation Conference*, New Orleans, Louisiana, USA, June 10-14 2002.

Bibliography

- [23] P. Kerntopf. A comparison of logical efficiency of reversible and conventional gates. In *International Workshop on Logic Synthesis*, pages 261–269, 2000.
- [24] P. Kerntopf. Maximally efficient binary and multi-valued reversible gates. In *International Workshop on Post-Binary ULSI Systems*, pages 55–58, Warsaw, Poland, May 2001.
- [25] P. Kerntopf. Synthesis of multipurpose reversible logic gates. In *EUROMICRO Symposium on Digital Systems Design*, pages 259–266, 2002.
- [26] R. W. Keyes and R. Landauer. Minimal energy dissipation in logic. *IBM J. Research and Development*, pages 152–157, March 1970.
- [27] M. H. A. Khan and M. Perkowski. Logic synthesis with cascades of new reversible gate families. In *6th International Symposium on Representations and Methodology of Future Computing Technology (Reed-Muller)*, pages 43–55, March 2003.
- [28] M. H. A. Khan and M. Perkowski. Multi-output ESOP synthesis with cascades of new reversible gate family. In *6th International Symposium on Representations and Methodology of Future Computing Technologies*, pages 144–153, March 2003.
- [29] A. Khlopotine, M. Perkowski, and P. Kerntopf. Reversible logic synthesis by iterative compositions. *International Workshop on Logic Synthesis*, pages 261–266, 2002.
- [30] J. Kim. *A study on Ensemble Quantum Computers*. PhD thesis, Korea Advanced Institute of Science and Technology, Korea, May 2002.
- [31] J. Kim, J.-S. Lee, and S. Lee. Implementation of the refined Deutsch-Jozsa algorithm on a three-bit NMR quantum computer. *Physical Review A*, 62, 2000.
- [32] J. Kim, J.-S. Lee, and S. Lee. Implementing unitary operators in quantum computation. *Physical Review A*, 62, 2000.
- [33] K. Kinoshita, T. Sasao, and J. Matsuda. On magnetic bubble logic circuits. *IEEE Transactions on Comput.*, C-25(3):247–253, March 1976.

Bibliography

- [34] R. Landauer. Irreversibility and heat generation in the computing process. *IBM J. Research and Development*, 5:183–191, 1961.
- [35] J.-S. Lee, Y. Chung, J. Kim, and S. Lee. A practical method of constructing quantum combinatorial logic circuits. Technical report, November 1999.
- [36] M. Lukac, M. Pivtoraiko, A. Mishchenko, and M. Perkowski. Automated synthesis of generalized reversible cascades using genetic algorithms. In *5th International Workshop on Boolean Problems*, pages 33–45, Freiburg, Germany, September 2002.
- [37] O. B. Lupanov. Schemes with the finite fan-outs. *Problemy Kibernetiki*. Fizmatgiz, Moscow (in Russian).
- [38] N. Margolus. *Feynman and Computation*, chapter Crystalline Computation. Perseus Books, 1999.
- [39] D. Maslov and G. Dueck. Asymptotically optimal regular synthesis of reversible networks. In *International Workshop on Logic Synthesis*, pages 226–231, Laguna Beach, CA, 2003.
- [40] D. Maslov and G. Dueck. Complexity of reversible Toffoli cascades and EXOR PLAs. In *12th International Workshop on Post-Binary ULSI Systems*, pages 17–20, Japan, May 2003.
- [41] D. Maslov, G. Dueck, and M. Miller. Fredkin/Toffoli templates for reversible logic synthesis. In *International Conference on Computer Aided Design*, November 2003.
- [42] D. Maslov, G. Dueck, and M. Miller. Templates for Toffoli network synthesis. In *International Workshop on Logic Synthesis*, pages 320–326, Laguna Beach, CA, 2003.
- [43] D. Maslov, G. Dueck, and M. Miller. Simplification of Toffoli networks via templates. In *Symposium on Integrated Circuits and System Design*, September 2003.
- [44] D. Maslov, G. Dueck, and N. Scott. Reversible logic synthesis benchmarks page. Technical report, <http://www.cs.unb.ca/profs/gdueck/quantum/>, August 2003.

Bibliography

- [45] D. Maslov and G. W. Dueck. Garbage in reversible design of multiple output functions. In *6th International Symposium on Representations and Methodology of Future Computing Technologies*, pages 162–170, March 2003.
- [46] R. C. Merkle. Reversible electronic logic using switches. *Nanotechnology*, 4:21–40, 1993.
- [47] R. C. Merkle. Two types of mechanical reversible logic. *Nanotechnology*, 4:114–131, 1993.
- [48] R. C. Merkle and K. E. Drexler. Helical logic. *Nanotechnology*, 7:325–339, 1996.
- [49] D. M. Miller. Spectral and two-place decomposition techniques in reversible logic. In *Midwest Symposium on Circuits and Systems*, Aug. 2002.
- [50] D. M. Miller and G. W. Dueck. Spectral techniques for reversible logic synthesis. In *6th International Symposium on Representations and Methodology of Future Computing Technologies*, pages 56–62, March 2003.
- [51] D. M. Miller, D. Maslov, and G. W. Dueck. A transformation based algorithm for reversible logic synthesis. In *Proceedings of the Design Automation Conference*, pages 318–323, June 2003.
-
- [52] A. Mishchenko and M. Perkowski. Reversible maitra cascades for single output functions. In *International Workshop on Logic Synthesis*, pages 197–202, 2002.
- [53] A. Mishchenko and M. Perkowski. Fast heuristic minimization of exclusive sum-of-products. In *5th International Reed-Muller Workshop*, pages 242–250, August 2001.
- [54] A. Mishchenko and M. Perkowski. Logic synthesis of reversible wave cascades. In *International Workshop on Logic Synthesis*, pages 197–202, June 2002.
- [55] G. E. Moore. Cramming more components onto integrated circuits. *Electronics*, 38(8), 1965.
- [56] M. Nielsen and I. Chuang. *Quantum Computation and Quantum Information*. Cambridge University Press, 2000.

Bibliography

- [57] A. Peres. Reversible logic and quantum computers. *Physical Review A*, 32:3266–3276, 1985.
- [58] M. Perkowski. Reversible computing for beginners. Lecture series, Portland State University, <http://www.ee.pdx.edu/~mperkows/>, 2000.
- [59] M. Perkowski, L. Jozwiak, P. Kerntopf, A. Mishchenko, A. Al-Rabadi, A. Coppola, A. Buller, X. Song, M. M. H. A. Khan, S. Yanushkevich, V. Shmerko, and M. Chrzanowska-Jeske. A general decomposition for reversible logic. In *5th International Reed-Muller Workshop*, pages 119–138, 2001.
- [60] M. Perkowski, P. Kerntopf, A. Buller, M. Chrzanowska-Jeske, A. Mishchenko, X. Song, A. Al-Rabadi, L. Jozwiak, A. Coppola, and B. Massey. Regularity and symmetry as a base for efficient realization of reversible logic circuits. In *International Workshop on Logic Synthesis*, pages 245–252, 2001.
- [61] M. Perkowski, P. Kerntopf, A. Buller, M. Chrzanowska-Jeske, A. Mishchenko, X. Song, A. Al-Rabadi, L. Jozwiak, A. Coppola, and B. Massey. Regular realization of symmetric functions using reversible logic. In *EUROMICRO Symposium on Digital Systems Design*, pages 245–252, 2001.
- [62] M. Perkowski, M. Lukac, M. Pivtoraiko, P. Kerntopf, M. Folgheraiter, D. Lee, H. Kim, W. Hwangbo, J.-W. Kim, and Y. W. Choi. A hierarchical approach to computer-aided design of quantum circuits. In *6th International Symposium on Representations and Methodology of Future Computing Technologies*, pages 201–209, March 2003.
- [63] P. Picton. Optoelectronic, multivalued, conservative logic. *International Journal of Optical Computing*, 2:19–29, 1991.
- [64] P. Picton. Modified Fredkin gates in logic design. *Microelectronics Journal*, 25:437–441, 1994.
- [65] P. Picton. A universal architecture for multiple-valued reversible logic. *MVL Journal*, 5:27–37, 2000.

Bibliography

- [66] J. Preskill. Lecture notes in quantum computing. Technical report, <http://www.Theory.caltech.edu/~preskill/ph229>.
- [67] J. Preskill. Fault-tolerant quantum computation. In H.-K. Lo, S. Popescu, and T. Spiller, editors, *Introduction to Quantum Computation and Information*, pages 213–269. World Scientific Publishing, 1999.
- [68] M. D. Price, S. S. Somaroo, A. E. Dunlop, T. F. Havel, and D. G. Cory. Generalized methods for the development of quantum logic gates for an NMR quantum information processor. *Physical Review A*, 60(4):2777–2780, October 1999.
- [69] M. D. Price, S. S. Somaroo, C. H. Tseng, J. C. Core, A. H. Fahmy, T. F. Havel, and D. G. Cory. Construction and implementation of NMR quantum logic gates for two spin systems. *Journal of Magnetic Resonance*, 140:371–378, 1999.
- [70] T. Sasao. *Switching theory for logic synthesis*. Kluwer Academic Publishers, Norwell, MA, 1999.
- [71] T. Sasao. Cascade realizations of two-valued input multiple-valued output functions using decomposition of group functions. In *International Symposium on Multiple-Valued Logic*, pages 125–132, May 2003.
-
- [72] T. Sasao and K. Kinoshita. Conservative logic elements and their universality. *IEEE Transactions on Computers*, c-28(9):682–685, 1979.
- [73] M. Schoenert. GAP. *Computer Algebra Nederland Nieuwsbrief*, 9:19–28, 1992.
- [74] V. V. Shende, A. K. Prasad, I. L. Markov, and J. P. Hayes. Reversible logic circuit synthesis. In *International Conference on Computer Aided Design*, pages 125–132, San Jose, California, USA, Nov 10-14 2002.
- [75] V.V. Shende, A.K. Prasad, I.L. Markov, and J.P. Hayes. Synthesis of reversible logic circuits. *IEEE Transactions on CAD*, 22(6):723–729, June 2003.
- [76] N. R. S. Simons, M. Cuhari, N. Adnani, and G. E. Bridges. On the potential use of cellular-automata machines for electronic field solution. *Int. J. Numer. Model. Electron.*, 8(3/4):301–312, 1995.

Bibliography

- [77] J. A. Smolin and D. P. DiVincenzo. Five two-bit quantum gates are sufficient to implement the quantum Fredkin gate. *Physical Review A*, (53):2855–2856, 1996.
- [78] N. Song and M. Perkowski. Minimization of exclusive sum of products expressions for multi-output multiple-valued input, incompletely specified functions. *IEEE Transactions on CAD*, 15:385–395, April 1996.
- [79] A. Steane. Quantum error correction. In H.-K. Lo, S. Popescu, and T. Spiller, editors, *Introduction to Quantum Computation and Information*, pages 184–212. World Scientific Publishing, 1999.
- [80] J. Stinson and S. Rusu. A 1.5 GHz third generation Itanium 2 processor. In *DAC*, pages 706–709, June 2003.
- [81] L. Storme, A. De Vos, , and G. Jacobs. Group theoretical aspects of reversible logic gates. *Journal of Universal Computer Science*, 5:307–321, 1999.
- [82] T. Toffoli. Reversible computing. *Tech memo MIT/LCS/TM-151, MIT Lab for Comp. Sci*, 1980.
- [83] A. De Vos. Towards reversible digital computers. In *European Conference on Circuit Theory and Design*, pages 923–931, Budapest, Hungary, 1997.
-
- [84] S. V. Yablonsky. *Introduction into the Discrete Mathematics*. Nauka, Moscow, Russia, 1978.
- [85] G. Yang, W. N. N. Hung, X. Song, and M. Perkowski. Majority-based reversible logic gate. In *6th International Symposium on Representations and Methodology of Future Computing Technologies*, pages 191–200, March 2003.
- [86] S. G. Younis and T. F. Knight Jr. Asymptotically zero energy split-level charge recovery logic. Technical Report AITR-1500, <http://citeseer.nj.nec.com/younis94asymptotically.html>, 1994.

Oct 1994 - May 1999 - teacher of the highest mathematics to the gifted schoolchildren of grades 6 to 9 in Lomonosov's Moscow State University (volunteer).

Oct 1997 - Dec 1999 - private company, programmer (data bases on Access/scientific programming on C).

Research Interests:

Reversible logic, reversible logic synthesis, quantum computations, EXOR minimization, cryptography, number theory.

Memberships and Professional Activities:

1. Member of SIGDA (since June 2003).
 2. Member of ACM (since March 2003).
-

Grants and Scholarships:

1. In 2003 has won Datatel Scholarship (\$700 US/year). [12 nominations in Canada]
 2. In 2003 was approved for SIGDA travel grant to IWLS-03 (maximum of \$570 US). [4 out of 22 were nominated]
 3. In 2000 the research was sponsored by RFFI grant (~\$150 CAN). [N/A]
 4. In 1994-1997 **four times** named Soros student of the year by International Soros Science Education Program (\$750 US/year * 4 years). [500 student nominations in Russia, each year]
 5. In 1993 had a high school stipend for excellence in studies and research. [9 stipends, ~250 students, Kolmogorov's high school]
-

Publications:

Journal publications:

1. D. Maslov. Generalized continued fractions. Discrete Mathematics Journal of Russian Science Academy, ISSN 0234-0860, vol. 10, series 4, Dec. 1998, pp. 39-60. //(in Russian, in English)

Submitted:

1. D. Maslov and G. Dueck. Reversible Cascades with Minimal Garbage. *Submitted to IEEE Transactions on Computer Aided Design* (July 2003).

2. D. Maslov and G. Dueck. Improved Quantum Cost for n -bit Toffoli gates. *Submitted to IEE Electronics Letters* (September 2003).

Chapters in books:

1. Helped to write the chapter about continued fractions in the book by S.B. Gashkov and V.N. Chubarikov "Arithmetic. Algorithms. Complexity of evaluations." //(in Russian)

Refereed conferences:

1. D. Maslov. Dynamic Programming Algorithms as Quantum Circuits: Symmetric Function Realization. *Submitted to SPIE*, section OR-18 (Quantum Information and Computation).
2. D. Maslov, G. Dueck, and M. Miller. Fredkin/Toffoli Templates for Reversible Logic Synthesis. International Conference on Computer Aided Design (ICCAD), San Jose, CA, November 2003 (*accepted*).
3. D. Maslov, G. Dueck, and M. Miller. Simplification of Toffoli Networks via Templates. 16th Symposium on Integrated Circuits and System Design, Sao Paulo, Brazil, September 2003, pp. 53-58.
4. M. Miller, D. Maslov, and G. Dueck. A Transformation Based Algorithm for Reversible Logic Synthesis. Design Automation Conference (DAC), Anaheim, CA, June 2-6, 2003, pp. 318-323.
5. G. Dueck, D. Maslov, and M. Miller. Transformation-based Synthesis of Networks of Toffoli/Fredkin Gates. IEEE Canadian Conference on Electrical and Computer Engineering, Montreal, Canada, May 4-7, 2003 (*refereed abstract*).
6. G. Dueck and D. Maslov. Reversible Function Synthesis with Minimum Garbage Outputs. 6th International Symposium on Representations and Methodology of Future Computing Technologies, Trier, Germany, March 10-11, 2003, pp. 154-161.
7. D. Maslov and G. Dueck. Garbage in Reversible Designs of Multiple-Output Functions. 6th International Symposium on Representations and Methodology of Future Computing Technologies, Trier, Germany, March 10-11, 2003, pp. 162-170.
8. G. Dueck, D. Maslov, J. T. Butler, V. Shmerko, and S. Yanushkevich. A Method to Find the Best Mixed Polarity Reed-Muller Expression Using Transeunt Triangle. 5th International Workshop on Applications of Reed-Muller Expansion in Circuit Design, Starkville, MS, August 10-11, 2001, pp. 82-93.

Non-refereed conferences/workshops/poster sessions:

1. D. Maslov. Dynamic Programming Algorithms As Reversible Circuits: Symmetric Function Realization. *Technical report TR03-161*, UNB, August, 2003.

2. D. Maslov and G. Dueck. Asymptotically Optimal Regular Synthesis of Reversible Networks. International Workshop on Logic Synthesis, Laguna Beach CA, May 28-30, 2003, pp. 226-231.
 3. D. Maslov, G. Dueck, and M. Miller. Templates for Toffoli Network Synthesis. International Workshop on Logic Synthesis, Laguna Beach CA, May 28-30, 2003, pp. 320-326.
 4. D. Maslov and G. Dueck. Complexity of Reversible Toffoli Cascades and EXOR PLAs, 12th International Workshop on Post-Binary ULSI Systems, Japan, May 16, 2003, pp. 17-20.
 5. D. Maslov. Reversible Logic Synthesis. Invited poster presentation on MITACS Fourth Annual Conference and Ottawa Interchange, Ottawa, Canada, May 8-10, 2003.
 6. D. Maslov. Reversible Synthesis Methods. Second prize on the first MITACS Atlantic Interchange Poster Session, Halifax, Canada, March 24, 2003.
 7. D. Maslov. Properties of the Decomposition of a Ratio into the Generalized Continuous Fraction with the Minimal Remainder. Conference on Applications of Computer Algebra (IMACS ACA), Saint-Petersburg, Russia, June 2000.
 8. A talk on generalized continued fractions on the Lomonosov's Conference, Lomonosov's Moscow State University, 1999.
 9. Second prize on the 3rd International Conference of Young Scientists, Hungary, Visegrad, April 29, 1994.
 10. Award by the certificate of the first degree on the Third Open Festival of Young Mathematicians and Physicists of Black Sea States, Ukraine, Odessa, September 27, 1993.
 11. Award by the certificate of the third degree on the Second International Conference of Young Scientists, Belarus, Minsk, May 7, 1993.
-

Invited Lectures:

1. Reversible Logic Synthesis. University of Michigan, Michigan, USA, August 4, 2003.