

**Acoustic communication in elephant seals
(*Mirounga leonina*): structural and functional
correlates of male vocalizations**

by

Simona Sanvito

A thesis submitted to the
School of Graduate Studies
in partial fulfilment of the
requirements for the degree of

Doctor of Philosophy

Department of Biology
Memorial University of Newfoundland

19th September 2006

St. John's
Newfoundland



Library and
Archives Canada

Bibliothèque et
Archives Canada

Published Heritage
Branch

Direction du
Patrimoine de l'édition

395 Wellington Street
Ottawa ON K1A 0N4
Canada

395, rue Wellington
Ottawa ON K1A 0N4
Canada

Your file *Votre référence*
ISBN: 978-0-494-31338-1
Our file *Notre référence*
ISBN: 978-0-494-31338-1

NOTICE:

The author has granted a non-exclusive license allowing Library and Archives Canada to reproduce, publish, archive, preserve, conserve, communicate to the public by telecommunication or on the Internet, loan, distribute and sell theses worldwide, for commercial or non-commercial purposes, in microform, paper, electronic and/or any other formats.

The author retains copyright ownership and moral rights in this thesis. Neither the thesis nor substantial extracts from it may be printed or otherwise reproduced without the author's permission.

AVIS:

L'auteur a accordé une licence non exclusive permettant à la Bibliothèque et Archives Canada de reproduire, publier, archiver, sauvegarder, conserver, transmettre au public par télécommunication ou par l'Internet, prêter, distribuer et vendre des thèses partout dans le monde, à des fins commerciales ou autres, sur support microforme, papier, électronique et/ou autres formats.

L'auteur conserve la propriété du droit d'auteur et des droits moraux qui protègent cette thèse. Ni la thèse ni des extraits substantiels de celle-ci ne doivent être imprimés ou autrement reproduits sans son autorisation.

In compliance with the Canadian Privacy Act some supporting forms may have been removed from this thesis.

Conformément à la loi canadienne sur la protection de la vie privée, quelques formulaires secondaires ont été enlevés de cette thèse.

While these forms may be included in the document page count, their removal does not represent any loss of content from the thesis.

Bien que ces formulaires aient inclus dans la pagination, il n'y aura aucun contenu manquant.

Canada

Abstract

Southern elephant seals (SES, hereafter) show the most extremely polygynous mating system of all mammals, with a very intense competition among males for access to females. Vocalizations are the most important component of SES male agonistic behaviour. Notwithstanding this, the knowledge of SES vocalizations was scanty, and mostly anecdotal, before I started studying them. During my previous research, I focused on the acoustic structure and the individual variation of vocalizations. The goal of my PhD research project was to study the development of male vocalizations, to understand their functions, to explore their relationships with male phenotype, and to assess their potential use as honest signals.

The first step was to analyze the male phenotypic traits that should be related to vocalizations. I studied body size and growth, as well as the development of the proboscis, a peculiar secondary sexual trait which role in vocalizations has always been controversial. I showed that the proboscis has indeed an active role in vocalization, and may serve as a way of elongating the vocal tract of the emitter, hence exaggerating the size information conveyed by acoustic signals with respect to the true size.

I then focussed on the different acoustic features of vocalizations. I showed that the temporal macro-structure of vocalizations, which is not constrained by vocal tract length or shape, is probably learned by young males through imitation of the older, most successful, breeders. On the contrary, the frequency features of vocalizations (formants,

in particular), which are constrained by the vocal tract length, have a predictable development pattern related to body growth.

Finally, I demonstrated that both source level and formant frequencies give reliable information about the phenotype of the emitter and, hence, are honest signals. But I also showed that the phenotypic information content of these signals is rather low. Vocalizations are, hence, a far from perfect assessment system, being very effective in settling contests between males when phenotypic differences are great, but not when interacting males have similar phenotypes.

Acknowledgments

Many people helped and supported me during these years of research, and to all of them I am very much grateful. Nevertheless, my first thanks goes to the elephant seals, for “kindly” providing the only really essential contribution to this research. Thanks for having “answered with enthusiasm” (well, you should hear their voice !) to my microphone approaches, and to have turned every field season into an unforgettable experience.

A very special thanks goes to Filippo, who has been through these years my best colleague, friend and mate. Thanks for initially introducing me to the elephant seals world and to the whole idea of scientific research and thanks for having made this whole study possible, from any point of view. But thanks in particular for having shared your life with me and for all the incredible (sometimes tough) experiences we lived through together.

A warm thanks goes to my supervisor, Prof. Ted Miller, for his support during those years, even when our timing at the university was not exactly synchronized. Thanks for having trusted me at the beginning and for our seals and acoustic discussions through the years. Last, but not least, thanks for friendly welcoming me in Newfoundland.

I am grateful to my committee members, Prof. Ian Jones and Prof. John Green for reviewing and improving the thesis draft. A particular thanks go to Prof. Harold Paddock, for the enlightening discussions about similarities between human and seal “speech”, and for his incredible patience with my bad English: our talks truly helped me in finding the way through an important part of this study. A sincere thanks also goes to this thesis

examiners, Dr. David Reby, Dr. Dawn Marshall and Dr. David Innes, for their critics and corrections.

I have spent half of my life in these last years in the field, and many people helped during this time. I would like to thank Alessia Gallastroni, Anna Fabiani, Ilaria Marzetti, Daniela Marasco, Chiara Braschi, Serena Cortinovis and Alice Camplani for their help with field data collection, for their friendship, and for the good and bad moments shared on the beaches. David and Patricia Gray, Jenny Luxton and the Sea Lion Lodge staff have always been wonderful in solving the big and small problems of everyday “camp” life, and I want to thank all of them so much for their kindness and for making all of us feeling at home on Sea Lion Island.

For the field work on Sea Lion Island, I thank the Falkland Islands Government for permission to conduct field research in the Falkland Islands; the Falkland Islands Development Corporation and Strachan Visick Ltd for allowing us to do the field work on Sea Lion Island, and for the help provided with the logistics. My research at Sea Lion Island was funded in part by Earthwatch Institute grants, a Strachan Visick Ltd. sponsorship, scholarships and fellowships from the CNR (Italian National Research Council), University of Milano, and Memorial University of Newfoundland.

For the field work conducted in the San Benito Island, I would like to thank Maria de la Concepción Garcia, for her help with logistics. I also would like to thank the Dirección General de Vida Silvestre for the granting of research permits, and the Cooperativa Nacionales Pescadores de Abulones for their warm help organizing our life on the islands (and for the excellent lobster and abalone dinners !).

Finally, I would like to thank all the people, too many to be mentioned here, that have been close to me in these years. Thanks to all my friends in Italy, who stayed close to me even when I was so far away and have always listened to my long elephant seals stories with lots of patience. And thanks to all my friends in Canada, who made my PhD experience “on the rock” the nicest possible.

I started studying seals a long time ago, and I am very much grateful to my family, for having always supported me, even when they might have thought I was a bit crazy. My brother, from the beginning, shared with me his experience as a researcher. My parents have been always present and have often participated enthusiastically in the different phases of the field preparation, from instrument designing to Italian food provisioning, making everything easier and more fun. It took long, but this thesis is dedicated to them.

Table of Contents

<i>Abstract</i>	<i>ii</i>
<i>Acknowledgments</i>	<i>iv</i>
<i>Table of Contents</i>	<i>vii</i>
<i>List of tables</i>	<i>xii</i>
<i>List of figures</i>	<i>xiv</i>
<i>List of abbreviations</i>	<i>xvii</i>
<i>Co-authorship statement</i>	<i>xix</i>
<i>I - Introduction</i>	<i>1</i>
I.1 Animal communication	1
<i>I.1.2 Mammalian vocal system</i>	<i>4</i>
<i>I.1.3 Communication in agonistic contests</i>	<i>9</i>
I.2 Sexual selection and competition between males	11
<i>I.2.1 Sexual selection in Pinnipeds and in the genus Mirounga</i>	<i>13</i>
I.3. Objectives of the research and thesis outline	16
Note to the appendices	22
I.4 LITERATURE CITED	24
<i>II - Body size and growth in male elephant seals</i>	<i>32</i>
II.1 ABSTRACT	32
II. 2 INTRODUCTION	33
II.3 METHODS	34
<i>II.3.1 Estimation of age</i>	<i>35</i>
<i>II.3.2 Estimation of body size</i>	<i>36</i>
<i>II.3.3 Statistics and modelling of growth</i>	<i>40</i>
II.4 RESULTS	41
<i>II.4.1 Estimation of an operational length-mass relationship</i>	<i>41</i>

II.4.2 Age-related variation in size (Table II.1)	43
II.4.3 Growth curves	47
II.5 DISCUSSION.....	50
II.5.1 The shape of southern elephant seal growth	50
II.5.2 Comparison with the northern elephant seal	51
II.5.3 Drawbacks of the study	53
II.6 LITERATURE CITED.....	55
<i>III - Having a big nose: structure, ontogeny and function of the elephant seal proboscis.....</i>	59
III.1 ABSTRACT.....	59
III.2 INTRODUCTION	60
III.3 METHODS.....	62
III.3.1 Estimation of age.....	62
III.3.2 Estimation of body length.....	63
III.3.3 Photogrammetric measurement of the proboscis.....	65
III.3.4 Measurement error and repeatability.....	68
III.3.5 Modelling proboscis growth	68
III.3.6 Allometry.....	70
III.3.7 Phenotypic selection.....	71
III.3.8 Statistics	73
III.4 RESULTS	75
III.4.1 Measurement error, repeatability and statistics (Table III.2)	75
III.4.2 Correlations among proboscis traits	75
III.4.3 Age-related variation in facial morphology.....	78
III.4.4 Allometry of the facial morphology.....	81
III.4.5 Phenotypic selection.....	87
III.5 DISCUSSION	91
III.6 LITERATURE CITED	97
<i>IV - Observational evidence of vocal learning in southern elephant seals: a longitudinal study.....</i>	104

IV.1 ABSTRACT	104
IV.2 INTRODUCTION.....	105
IV.3 METHODS	107
IV.4 RESULTS	113
IV.5 DISCUSSION	121
IV.6 LITERATURE CITED.....	125

V - Ontogeny of male elephant seal vocalizations: maturation and learning
..... 130

V.1 ABSTRACT	130
V.2 INTRODUCTION	131
V.3 METHODS.....	134
<i>V.3.1 Estimation of age</i>	<i>134</i>
<i>V.3.2 Sound recording</i>	<i>135</i>
<i>V.3.3 Spectral analysis.....</i>	<i>136</i>
<i>V.3.4 Acoustic measurements.....</i>	<i>138</i>
V.3.4.1 Temporal parameters	139
V.3.4.2 Intensity parameters.....	139
V.3.4.3 Frequency parameters.....	140
V.3.4.4 Spectrum overall shape.....	143
V.3.4.5 Internal structure of a bout.....	144
<i>V.3.5 On estimation of formants</i>	<i>144</i>
<i>V.3.6 Modelling of the variation of acoustic features with age</i>	<i>146</i>
<i>V.3.7 Measurement error and repeatability of acoustic features</i>	<i>147</i>
<i>V.3.8 Behavioural data collection and analysis</i>	<i>148</i>
<i>V.3.9 Personality.....</i>	<i>150</i>
<i>V.3.10 Statistics.....</i>	<i>151</i>
V.4 RESULTS.....	152
<i>V.4.1 Measurement error, repeatability and seasonal changes of acoustic features.....</i>	<i>152</i>
<i>V.4.2 Age specific variation of acoustic features.....</i>	<i>154</i>
<i>V.4.3 Age related change in within-individual variability.....</i>	<i>163</i>
<i>V.4.4 Age related change in among- individual variability.....</i>	<i>166</i>
<i>V.4.5 Ontogeny of vocal behaviour.....</i>	<i>168</i>

<i>V.4.6 Ontogenesis of personality</i>	172
V.5 DISCUSSION	173
<i>V.5.1 Variation of the mean value of acoustic features</i>	178
<i>V.5.2 Within-male variation of the variability of acoustic features</i>	179
<i>V.5.3 Among-male variability of acoustic features</i>	180
V.6 LITERATURE CITED	183
<i>VI - Source level of male vocalizations in the genus <i>Mirounga</i>: repeatability and correlates</i>	191
VI.1 ABSTRACT	191
VI.2 INTRODUCTION	192
VI.3 METHODS	194
VI.4 RESULTS	198
<i>VI.4.1 Source level</i>	198
<i>VI.4.2 Differences among the species</i>	199
<i>VI.4.3 Correlations with male phenotype</i>	199
VI.5 DISCUSSION	202
VI.6 LITERATURE CITED	207
<i>VII - Vocal signalling of male southern elephant seals is honest but imprecise</i>	211
VII.1 ABSTRACT	211
VII.2 INTRODUCTION	213
VII.3 METHODS	218
<i>VII.3.1 Recording protocol and acoustic analysis</i>	219
<i>VII.3.2 Age estimation</i>	220
<i>VII.3.3 Body size estimation</i>	221
<i>VII.3.4 Proboscis traits measurements</i>	221
<i>VII.3.5 Behavioural observation and agonistic activity index</i>	222
<i>VII.3.6 Resource holding potential</i>	223
<i>VII.3.7 Vocal tract estimation</i>	224
VII.3.7.1 Expected vocal tract length from the formant frequencies ..	224

VII.3.7.2 Expected formant frequencies from the external morphology	224
VII.3.8 Statistics	228
VII.4 RESULTS.....	229
VII.4.1 Correlation among acoustic features and among phenotypic traits.....	229
VII.4.2 Frequency features and phenotypic traits.....	229
VII.4.2.1 Age	229
VII.4.2.2 Body length	233
VII.4.2.3 Agonistic activity	234
VII.4.3 Frequency features and resource holding potential	234
VII.4.4 A model for elephant seal vocal tract	235
VII.4.4.1 Relationship among minor formant and phenotype	235
VII.4.4.2 Vocal tract model	238
VII.5 DISCUSSION.....	241
VII.6 LITERATURE CITED	248
VIII - CONCLUSIONS.....	255
VIII.1 Mating system, inter-male competition, and the role of communication	255
VIII.2 Vocal communication and learning in male elephant seals	257
VIII.3 Behavioural and acoustic ontogeny of vocalizations.....	259
VIII.4 The function of agonistic vocalizations	262
VIII.5 Drawbacks of the study and future developments.....	266
VIII.6 LITERATURE CITED	273
APPENDIX I - ELEPHANT SEALS BREEDING BIOLOGY.....	280
AI.1 General description of elephant seals breeding biology	280
AI.2 Elephant seal agonistic behaviour	286
AI.3 Elephant seal male vocalizations	287
AI.4 LITERATURE CITED.....	296

List of tables

Table II.1 - Body length and mass of different age classes	45
Table II.2 - Absolute and relative growth in different male age classes.....	46
Table II.3 - Growth curves fitted for body length.....	49
Table III.1 - Definition of morphological variables considered in this study	66
Table III.2 - Descriptive statistics of morphological traits	74
Table III.3 - Covariance and correlation matrix for proboscis traits	77
Table III.4 - Change of morphological traits with age	79
Table III.5 - Comparison of simple linear regression and piecewise regression.....	83
Table III.6 - Linear regression and piecewise regression models of growth of facial morphology	84
Table III.7 - Allometry of facial morphology.....	86
Table III.8 - Selection differentials and selection intensities on facial traits	89
Table III.9 - Selection gradients on proboscis traits	90
Table IV.1 - Percentages of vocal types changed over the 8-year study	120
Table V.1 - Comparison of young and old males acoustic parameters.....	155
Table V.2 - Average values of frequency domain parameters for different age classes.	156
Table V.3 - Average values of temporal, intensity and structural parameters for different age classes.....	157
Table V.4 - Random regression model analysis of some acoustic parameters with age.	158
Table V.5 - Piecewise linear models of formant frequencies versus age.....	161
Table V.6 - Mean within male CVs for different age classes	165

Table V.7 - Among-male variation in acoustic features of young and old males	167
Table V.8 - Age specific statistics for various behavioural measures of social interaction and vocalization	169
Table V.9 - Comparison of count regression models applied to the behavioural measures of social interaction and vocalization	170
Table VI.1 - Samples, SL repeatability, and individual SL statistics	196
Table VII.1 - Covariance and correlation matrix for frequency features and phenotypic traits.....	230
Table VII.2 - Simple linear regressions of phenotypic traits vs frequency features.....	231
Table VII.3 - Simple linear regression analysis of competition success and RHP indexes vs frequency features	236
Table VII.4 - Multiple regression of minor formant with phenotype features	239
Table VII.5 - Vocal tract estimation for adult male elephant seals	242

List of figures

Figure I.1 - The source-filter model of human vocalization.....	6
Figure I.2 - Effect of shape of the supralaryngeal vocal tract on formants	8
Figure II.1 – Photograph of an adult male during a photogrammetric session.....	39
Figure II.2 – Relationship between body length and body weight in male SES at SLI ...	42
Figure II.3 – Observed growth in body length and mass of SLI male elephant seals	44
Figure II.4 – Growth of individual males, and fitted growth models	48
Figure II.5 – Relative growth of elephant seal males	52
Figure III.1 - The photogrammetric method, used for measurement of the proboscis.....	64
Figure III.2 - Diagram of the measured traits.....	67
Figure III.3 - Boxplots of the distribution of the main proboscis traits.....	76
Figure III.4 - Elephant seal facial development with age.....	80
Figure III.5 - Scatterplots of some facial traits over age	82
Figure III.6 - Scatterplots of some facial traits over body length.....	85
Figure III.7 - Non parametric univariate fitness functions of some proboscis traits.....	88
Figure IV.1 - Male elephant seal vocalization.....	110
Figure IV.2 - Vocal types	112
Figure IV.3 - Vocalizations change from non-structured to structured with growth.....	119
Figure V.1 - Spectrogram and average power spectrum of one bout.....	137
Figure V.2 - Some of the frequency and spectrum overall shape parameters.....	141
Figure V.3 - Variation with age of the repeatability of some acoustic features.....	153

Figure V.4 - Individual variation of acoustic parameters	159
Figure V.5 - Age specific change in formant frequencies	162
Figure V.6 - Boxplots of within-individual acoustic variation of some acoustic parameters in young and old animals.....	164
Figure V.7 - Boxplots of the age specific percentage of interactions in which the male emits one or more vocalization, and the percentage of interactions in which the vocalization actually let the male win the interaction.....	171
Figure V.8 - Bar charts of the variation among age categories of the percentage of vocal personalities and distressed + runaway personalities.....	174
Figure VI.1 - Boxplots of SL split by population and year	200
Figure VI.2 - Mean and 95% confidence interval of SL of southern elephant seal age classes	201
Figure VI.3 - Scatterplot of SL versus nose-tail length as estimated by the photogrammetric method	203
Figure VII.1 - Elephant seal male during vocalization.....	226
Figure VII.2 - Vocal tract measurement during vocalization.....	227
Figure VII.3 - Variation of age and length with the F5 and formant dispersion	232
Figure VII.4 - Variation of competition success and RHP index with the F5 and formant dispersion	237
Figure VII.5 - Variation of minor formant with trunk length.....	240
Figure AI.1 - The study site	281
Figure AI.2 - Southern elephant seal biology	282
Figure AI.3 - Southern elephant seal breeding biology	285

Figure AI.4 -Vocalizing postures used during agonistic interactions.....289

Figure AI.5 - Typical snort vocalization of adult male southern elephant seal292

Figure AI.6 - Typical submissive vocalization of adult male southern elephant seal294

List of abbreviations

AD = Adult

AIC = Akaike Information Criterion

BP = Bending Point

Db = Decibel

DS = David's score

ENFI = Estimated Number of Females Inseminated

FFT = Fast Fourier Transform

JUV = Juvenile

LPC = Linear Predictive Coding

LR = Likelihood Ratio

MA = Major Axis

MAD = Median Absolute Deviation

NB = Negative Binomial

NES = Northern Elephant Seal

OLS = Ordinary Least Square

P = Poisson

PCA = Principal Component Analysis

RHP = Resource Holding Potential

SAM = Sub Adult Male

SBI = San Benito Island

SES = Southern Elephant Seal

SL = Source Level

SLI = Sea Lion Island

SLR = Single Lens Reflex

SMA = Standard Major Axis

SPL = Sound Pressure Level

VIF = Variance Inflation Factor

VTL = Vocal Tract Length

ZINB = Zero Inflated Negative Binomial

Co-authorship statement

Many people participated in this work, in particular during the field data collection, while some of them actively contributed in the actual manuscript preparation. I am the principal author of all the manuscripts of this thesis work and I have been in charge of all the stages of this research, from design and identification of the research proposal, to the practical aspects of the data collection in the field, to data analysis and manuscript preparation. Dr. Filippo Galimberti, who is co-author in all the manuscripts, participated in all the phase of this research, being my long time colleague, and his contribution was particularly relevant for the data analysis, being him an expert in statistics. Dr. Edward Miller, my thesis supervisor, also is co-author, and his main contribution was in the manuscript drafting and final preparation phase. Chiara Braschi is co-author for chapter 2: she collected part of the data presented in this manuscript and helped in their analysis.

I - Introduction

I.1 Animal communication

Communication occurs when the actions of (or cues given by) one animal influence the behaviour of another (Wiley, 1983). Responses to such actions or cues (signals) can be overt and prompt, but also cryptic and delayed with regard to their emission, hence responses can be difficult to recognize and signal functions difficult to understand (Miller, 1991). Animal communication has been a central topic in ethology and sociobiology, and has long figured in evolutionary theory (Darwin, 1871; 1872; Wilson, 1975). However, concepts have changed: in the late '70s, Krebs and Davies (1978) stressed the difference between the traditional ethological view of communication (Tinbergen, 1952) , and a newer, more “cynical”, view. In the traditional approach, behaviour was seen as a largely cooperative process, and communication was considered as a way to share information and coordinate actions among co-specific animals. In contrast, the newer and now leading vision of communication is based on selfishness, with animals behaving to preserve and propagate their own genes, a goal that can be achieved by exploitation of other individuals (Bradbury and Vehrencamp, 1998). Therefore, communication now is viewed mainly as a manipulative process, with emphasis on the competition between individuals, and information that is provided in communication being partly false or unreliable. Natural selection favours individuals who manipulate the behaviour of others, whether or not this confers advantage on manipulated ones. This selects for skepticism in receivers, who may probe or test senders to obtain

further or more accurate information (Krebs and Dawkins, 1984). The sociobiological approach (Wilson, 1975) and the emphasis given to selection at individual level (Williams, 1966), led to wide acceptance of the idea that often animals have conflicts of interests, and that communication can be interpreted as an arm race between senders and receivers (Dawkins and Krebs, 1979).

There is a large variation in communication patterns, types of information transmitted, and sensory channels used. This variation is in part due to ecological and social constraints, that drive the evolution of communication (Badyaev and Leaf, 1997; Boarman, 1990). Moreover, signal evolution is also constrained by the specific life-history of each species (Endler, 1993; Johnstone, 1997) and by phylogeny (Irwin, 1996). Animal communication often entails the simultaneous and congruent emission of many different signals together, directed towards the whole sensory system of the receiver (Miller, 1991). Each type of signal has its own costs and benefits, which depend on the contests in which they are emitted. The efficiency of transmission of each one, together with the kind of information transmitted, makes a certain kind of communication more advantageous than another.

1.1.1 Acoustic communication

Acoustic communication offers some advantages, because it is energetically cheap and flexible. Sound production is usually a rather low cost activity with respect to other forms of communication (Bradbury and Vehrencamp, 1998). Sounds propagate quickly in every direction, and can carry a great amount of information by simply changing properties such as duration, intensity and frequency (Harper, 1991).

Sounds result from vibration of objects that produces variation in the local concentrations of molecules in the medium (Bradbury and Vehrencamp, 1998). Vibrations can be produced by a wide set of objects, including the vocal folds of mammals and the syrinx of birds. Basic sounds produced by vibrating structures may be further modified by transmitting them through a resonator, like the mammal vocal tract. Resonators, or filters, may modify the frequency spectrum of sounds before their emission, enhancing some frequency components and reducing others (Bradbury and Vehrencamp, 1998). When sound waves reach an auditory receptor (e.g., a membrane or tympanum), the local variations of compression in the medium are converted to variations in electrochemical potential at the neuronal level which reach the central nervous system for processing. Each species evolved very different auditory systems, characterized by very different sensibility in the temporal, intensity and frequency domain, depending on the selective pressures acting on each one, on the physical aspects of the transmission medium (Wiley and Richards, 1978) and on the phylogenetic constraints (Irwin, 1996).

From a physical point of view, sound propagates in air as micro-fluctuations of the atmospheric pressure. The amplitude of the variation in pressure around its mean value represents the sound intensity. The number of times in a second that the pressure reaches its maximum value represents the fundamental frequency. Animal sounds are usually not stationary, i.e. continuous and homogeneous (pure tones), since the transmission of information is based largely upon the modulation of sound properties. Often animals produce sounds which are modulated in frequency and/or intensity, or composed of a train of distinct pulses.

Two groups of animals have evolved acoustic communication, arthropods and

vertebrates (Bradbury and Vehrencamp, 1998). Many different types of organs are used to produce sounds, resulting in very different acoustic emissions. For examples, stridulations are characteristics of arthropods, and are produced by rubbing knurled body parts together; arthropods also produce sounds by whistling in the windpipes. Some animals, as for instance kangaroo rats and woodpeckers, produce sounds by percussion of different body parts (i.e. the beak or feet) against features of their habitat (trees or terrain), while some fishes exploit the vibrations produced by muscular actions to produce sounds. Vocalizations are peculiar to terrestrial vertebrates and are produced by a general mechanism, made up of two components: an air flux pushed through a tube, where some membranes are put in vibration, hence producing a sound which can be further modified by the resonance properties of the tube itself (Bradbury and Vehrencamp, 1998).

1.1.2 Mammalian vocal system

In terrestrial mammals, the air flow produced by lungs is converted into acoustic energy by the larynx, which is the source of the sound produced. The larynx contains two elastic membranes, the vocal folds, which are put in vibration by the air pressure provided by the lungs. The larynx converts the steady air flow coming from the lungs into a series of puffs, generating a periodic or quasi-periodic sound wave, whose fundamental frequency equals the pulse rate of the vocal folds (Bradbury and Vehrencamp, 1998; Rubin and Vatikiotis-Bateson, 1998). Vocal fold length, mass, thickness and elasticity, together with air pressure generated from the lungs, determine vibration rate (*i.e.*, fundamental frequency of a vocalization: Fry, 1979).

The source-filter model of human vocalization can be summarized as follows

(Fant, 1960; Müller, 1848). After a sound is produced in the larynx as the source signal, it travels through the supra-laryngeal portion of the vocal tract (trachea, pharynx, oral cavity, nasal cavity) before being emitted into the environment. The supra-laryngeal vocal tract acts as a spectral filter of the source signal. The column of air in the vocal tract has a particular elasticity, mass and shape, and therefore vibrates preferentially at certain resonant frequencies, whereas other frequencies are attenuated (Figure I.1). In humans (and increasingly in non-human mammals) the resonant frequencies are referred to as formants (Fitch and Hauser, 2002). Overall size, shape and volume of the supra-laryngeal vocal tract, which vary interspecifically, and within species also vary individually and with age and sex, determine the filtering function and, hence, formants produced. As a rule of thumb, the longer the vocal tract, the lower and less spaced (dispersed) will be the formants (Fitch, 1997; Fry, 1979).

The source-filter model has been applied to non-human mammals (Fitch, 2000; Fitch and Hauser, 2002). In its simplest form, the vocal tract is modelled as a uniform tube, closed at one end (the glottis) and open at the other end (the lips). This model is obviously a great simplification of the actual sound production process in humans and other mammals, since the vocal tract is hardly a perfect uniform tube. For example, the descended larynx of humans and some other species results in a long pharyngeal cavity, long total vocal tract, and bent shape (Fitch and Reby, 2001; Rubin and Vatikiotis-Bateson, 1998). Moreover, in some species (e.g. many primates, including humans) the shape of the upper vocal tract can be altered through changing the position of the articulators (jaw, tongue, lips), or by opening or closing the nasal passage. The different articulators can easily adjust to form a variety of cavities and shapes, producing the wide

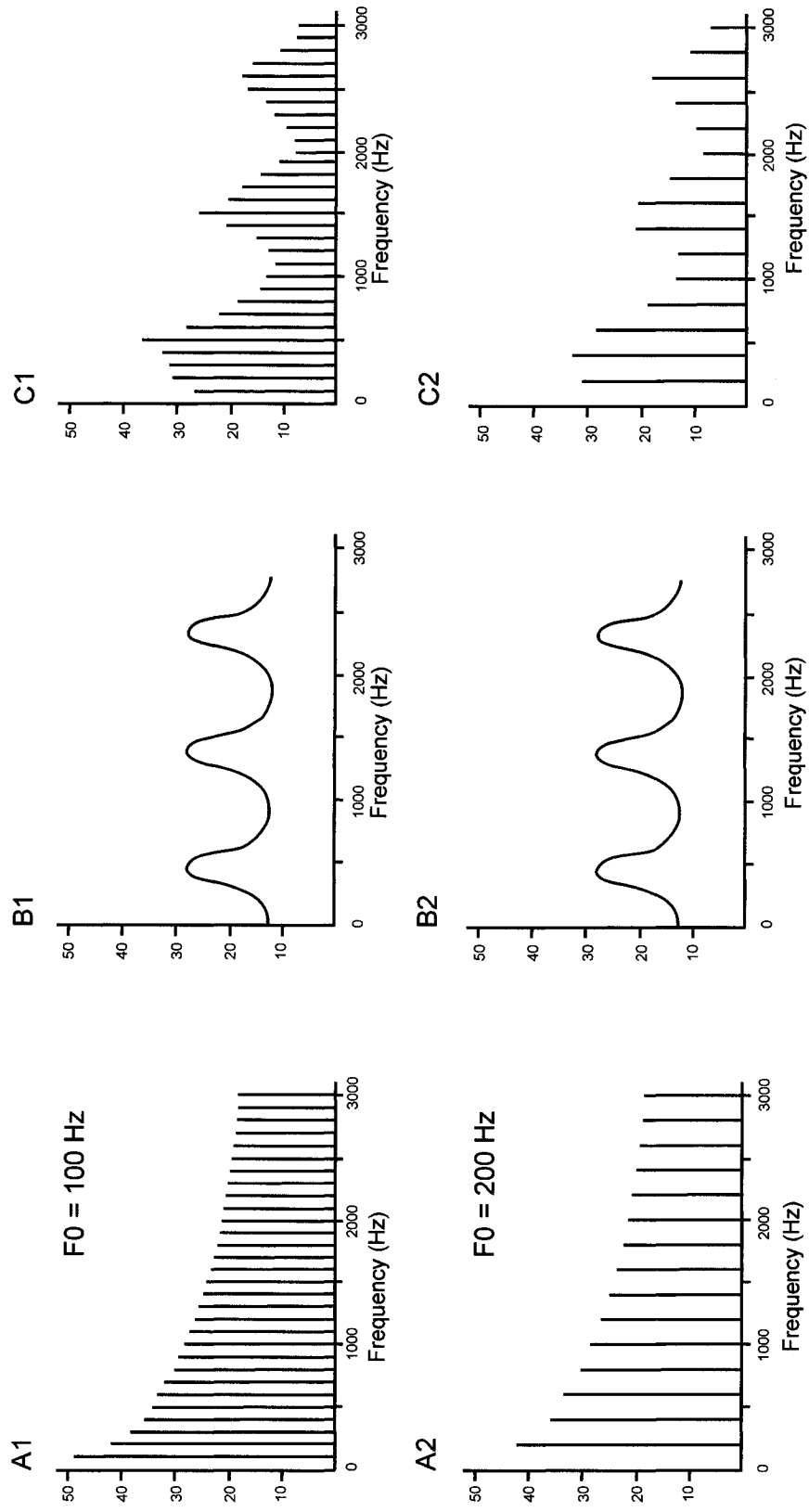

Figure I.1 - The source-filter model of human vocalization. A1 and A2 represent the harmonic spectrum of the source signal produced at the vocal folds, with pulse rates (i.e. fundamental frequency, F0) of 100 Hz and 200 Hz respectively. Other vertical lines represent *harmonics* (integral multiples) of F0. B1 and B2 represent the filtering function of the supralaryngeal vocal tract, and C1 and C2 represent the resultant spectra of the vocalizations, showing the first three formants and underlying harmonic structure (after Hopp et al., 1998, p. 253).

range of formants patterns which, in humans, are the building material for speech. Recently, deeper knowledge of human vocal anatomy, together with advances in computer technology, allowed the development of sophisticated models, which permit us to relate the combined movements of the different articulators with the acoustic output (Rubin and Vatikiotis-Bateson, 1998). In particular, it was demonstrated that the first three formants are the ones more affected by changes in the vocal articulators, in particular mouth opening and tongue position, and are responsible for the different vowels present in human speech (Figure I.2).

In summary, most mammalian vocalizations are produced by three factors: air flow originated from lungs; rate of vibration of the vocal folds (which produce the source sound); and filtering properties of the supra-laryngeal vocal tract (which shapes the final acoustic output). Anatomical and physiological factors represent a physical constraint to vocal production, influencing the range of sounds that can be produced, suggesting that mammalian vocalization could provide reliable information about vocalizing individuals, since produced sounds depend directly on the organs involved in sound production. For example, lungs size coupled with strength of thoracic muscles could determine the quantity of air available for vocalizations or the power with which it can be exhaled and, therefore, could be related to either maximum length of a single call or to its maximum intensity (Fitch and Hauser, 2002; Titze, 1994). Vocal folds determine fundamental frequency, and the supra-laryngeal vocal tract determines formant structure and dispersion. In theory, lungs and vocal-tract size might be strongly correlated with body size, while vocal folds less so (Fitch and Hauser, 2002; Rendall et al., 2005). Therefore some acoustic features could act as honest and reliable indicators of an emitter's

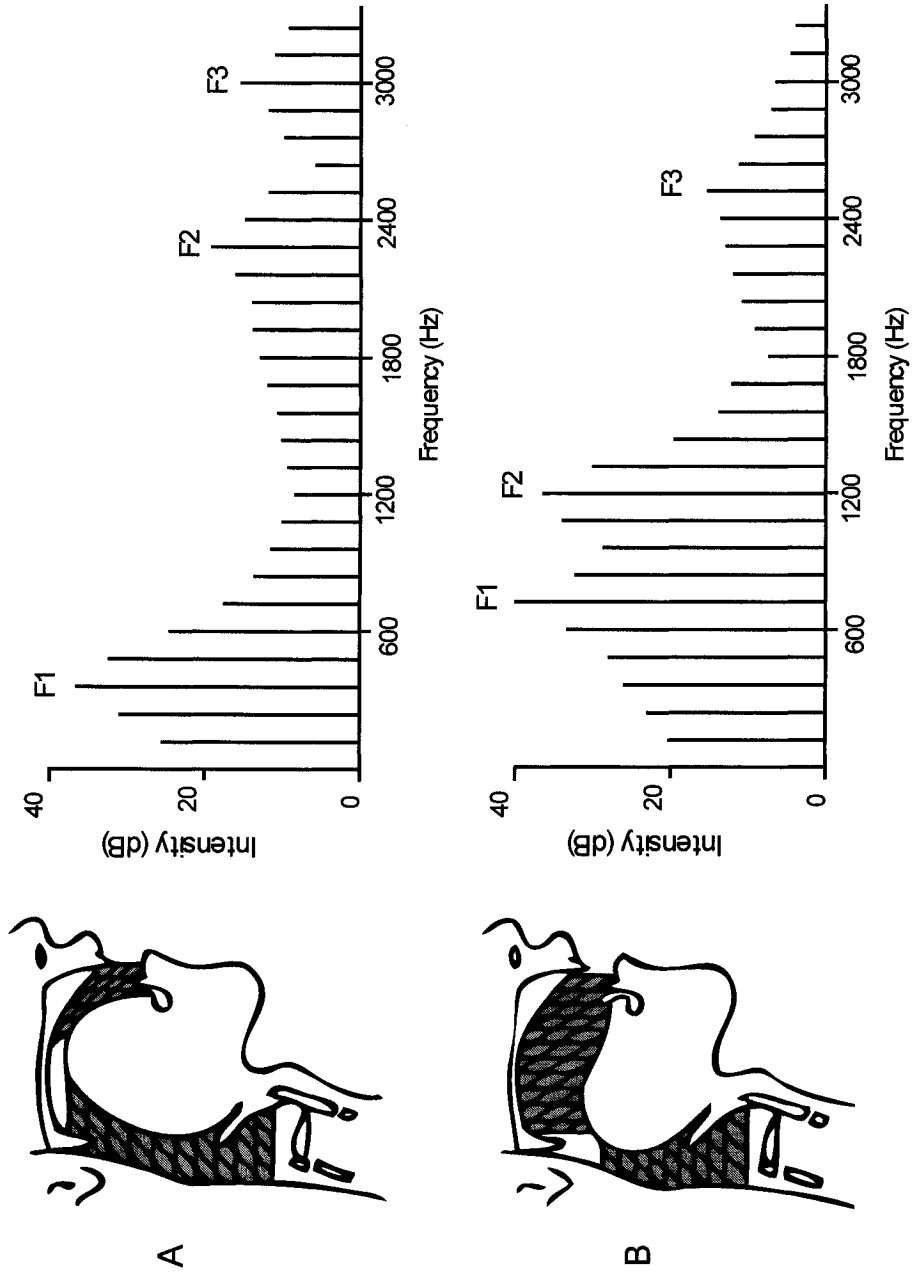

Figure 1.2 - Effect of shape of the supralaryngeal vocal tract on formants. A shows vocal tract configuration during the emission of the letter [i:] and its spectrum. B is the same for the letter [a:]. F1, F2 and F3 are the first three formants. The fundamental frequency in the given example is 120 Hz (after Fry, 1979, p.77).

phenotype purely due to their physical and mechanical relationships with the rest of the body structure.

1.1.3 Communication in agonistic contests

One of the consequences of intra-sexual competition is the evolution of structures used to threaten and fight opponents. The directional selection pressures generated by competition may lead to the evolution of traits to be used in the conventional phase of contests, including coloration, ornaments, exaggerated secondary sexual traits, acoustic signals and behavioural displays (Andersson, 1994; Guilford and Dawkins, 1995; Maynard Smith and Harper, 1988). The use of signals may permit avoidance of direct fights, and may determine the outcome of the contest without costly and risky behaviours, although the frequency and importance of fights, and of their consequences (e.g., wounds), should not be underestimated (Geist, 1974; Geist, 1986). Contests can be settled in three different ways (Maynard Smith and Harper, 1988): 1) by an all out fight, in which the animals settle the dispute by fighting, and the outcome of the contest depends on their relative resource holding potential (RHP); 2) by a limited fight, in which the winner is the animal prepared to fight more intensely or for longer, and the outcome of the contest is determined by aggressiveness; 3) by signals, in which the contest is settled by signals, either strictly related to RHP (cannot be faked), or conventional, i.e., not directly related to RHP (and can, in principle, be faked).

When an individual fights to obtain a certain resource, the choice of the best strategy to adopt depends on the resource value and the assessment of the opponent potential in relation to its own. Conventional behaviours in general, and vocal signalling

in particular, can have a great importance here. Assessment signals are necessarily related to RHP or some aspect of the animal condition and, by definition, cannot be faked. Behaviours in which body size is emphasized and displayed, as well as morphological structures that enhance it, are examples of assessment signals. The same holds for vocal signals in which some acoustic feature is directly related to the emitter phenotype. For example, in various ungulate species (*Cervus elaphus*: Clutton-Brock and Albon, 1979; *Dama dama*: McElligott and Hayden, 1999), males emit a vocalization during the breeding season to advertise their status, and the intensity and continuity of this vocalization is related to their size and performance in the breeding competition. Conventional signals are more controversial. They may or may not be related to some underlying quality, but there is no physical reason why they must be so (Maynard Smith and Harper, 1988). For conventional signals, the link between signal design and message is either arbitrary or it is a strategic, rather than obligated, correlate of individual ability. Zahavi (1993), with his handicap principle went farther, pointing out that it is probably better to abandon the whole idea of conventional signals, since almost every signal (apart from a few very special ones, such as human language) may be reinterpreted as a costly and reliable system because of the investment the sender put into them. Mammal vocal communication during agonistic contests may be included in the assessment signals category, and may give reliable information about the emitter phenotype, due to the physical relationships that tie together mammal vocal anatomy and its resultant acoustic output.

I.2 Sexual selection and competition between males

"Since in such cases the males have acquired their present structure, not from being better fitted to survive in the struggle for existence, but from having gained an advantage over other males, and from having transmitted this advantage to their male offspring alone, sexual selection must here have come into action. It was the importance of this distinction which led me to designate this form of selection as Sexual Selection." (Darwin, 1871). Sexual selection is the result of individual variation in mating success related to the variation of phenotype of individuals. Darwin considered this kind of selection so interesting, powerful and widespread as to deserve a specific name, distinct from natural selection (Darwin, 1859). Notwithstanding the relevance of this idea in Darwin's evolutionary theory (Darwin, 1871), this topic was rather neglected until the beginning of the 70's (Campbell, 1972). After this turning point, sexual selection became one of the hot topics of evolutionary biology, with pervasive implications, from behaviour to speciation (Andersson, 1994).

Sexual selection is the general label for a series of complex phenomena. It is customary to split sexual selection into intra-sexual and inter-sexual selection. The former is the competition between members of one sex to get access to mating partners of the other sex, the latter is the choice of mating partners of the other sex. In mammals, the two processes are usually equated, respectively, to male competition and female choice (Andersson, 1994). This is because, due to the basic breeding biology of mammals (internal fertilization, female pregnancy, high gestational cost for the female, modest opportunity for the male to invest in offspring before parturition), females are usually the

limiting sex, and males compete for them (Trivers, 1972). In each specific system, the net sexual selection pressure on each individual trait is the result of both intra- and inter-sexual selection, and the relative importance of each process will depend in part on the general breeding biology of the species, and in part on the details of the local breeding situation, at the population or lower level (Mateos, 1998). Moreover, each of the two processes, intra and inter-sexual selection, comprises many different mechanisms. For example, male competition may result in the direct defense of female groups, in the defence of resources used by females, in the searching for oestrus females and scramble competition over them, or in endurance rivalry (Andersson, 1994). Both intra- and inter-sexual selection can be directed towards any sort of phenotypic trait at large, including signals. Even a casual survey of the literature demonstrates that both phenomena deserve attention, and the current prevalence of interest, both theoretical and empirical, in female choice seems the result of evolutionary success of a "sexy" meme. The role of male contests has been much less controversial than female choice, and this may explain the greater attention put on the latter mechanism. In specific instances, this bias has led to seriously underestimate the role of male-male competition (Beehler and Foster, 1988).

Intrasexual competition for mates may be classified in the following categories (Andersson, 1994)

- Scrambles, i.e., the search and association with a mate only for the reproductive period. This kind of competition will favour the evolution of well developed sensory organs and motor abilities, since the rapid location of the mate is crucial for success.
- Endurance rivalry, i.e., the ability to remain longer at a breeding site and mate with females that otherwise would mate with other males. Mating success will be correlated

with the length of time spent at such sites and all factors able to increase efficiency in the storage of energy will be favoured.

- Contests. Rivals display to or fight each other in competition over mates (or resources needed to attract mates). Strength, large size and weapons will be favoured by this modality of sexual selection, as well as conspicuous signals (Fisher, 1930). Weapons themselves can be used in agonistic displays (and not just to actually fight), and may therefore serve as weapons as well as signals for intimidating opponents. Horns and antlers for example are at least roughly correlated with body size, and could be used therefore to assess each other during agonistic interactions, in order to avoid fights with superior competitors (Clutton-Brock, 1982; but see Jennings et al., 2003). The same holds for acoustic signals. In many species of the *Cervidae* the roaring emitted by males during the breeding season has been shown to be used both as a generic way to advertise breeding status and as a specific way to assess contestants (*Cervus elaphus*: Clutton-Brock, 1979; *Capreolus capreolus*: Reby et al., 1999).

1.2.1 Sexual selection in Pinnipeds and in the genus Mirounga

"If we turn to the marine Carnivora, as we shall hereafter see, the case is widely different; for many species of seals offer extraordinary sexual differences, and they are eminently polygamous." (Darwin, 1871).

Pinnipeds have breeding patterns that seem to favour sexual selection, because, at least in land-breeding species, the concentration of breeding activities in time and space leads to skewed sex ratios, an important prerequisite of sexual selection (Bartholomew,

1970; Boness, 1991). Notwithstanding the female fecundity advantage of large body size found in most pinniped species (Boyd, 1998), males are the largest sex in many cases, with levels of sexual dimorphism in size that have no equivalents in other mammals (Lindfors et al., 2002; Weckerly, 1998). Elephant seals (*Mirounga* spp.) are frequently cited in textbooks as the most polygynous mammal, in which sexual selection by competition for females reaches its highest level (Andersson, 1994).

Most of the information on sexual selection and male competition in elephant seals come from the northern species, *M. angustirostris* (Le Boeuf and Laws, 1994; NES hereafter). On the contrary, and with some notable exceptions (Braschi, 2004; Laws, 1956; McCann, 1981; Modig, 1996), research on the southern species (*M. leonina*, SES hereafter) has concentrated on female breeding biology. Male competition is obviously an important component of sexual selection also in the southern species. Females gather on land to give birth, forming groups, customarily called harems, of up to a few hundred individuals. Males build up local dominance hierarchies by direct fights and conventional agonistic interactions (McCann, 1981), and these hierarchies are linear and very stable, more than in the NES (Galimberti et al., 2003). The locally most dominant male gets control of the local harem, and the number of females in the harem held is related to the global competitive success (Galimberti, 1995). Harem holders do most of the copulations, and they sire most of the pups (Fabiani et al., 2004). Variance of breeding success is much higher than expected from a random process of allocation of copulation, and it is probably the highest of all animal species (Galimberti et al., 2002). Success in competition and breeding are related to both the variation in structural and behavioural traits, and to the local breeding situation (Galimberti, 1995; Modig, 1996). More details

on the general breeding biology of southern elephant seals can be found in Appendix I.

While the role of intra-sexual selection is certain, the importance of female choice in the elephant seals mating system is dubious. A pre-requisite of female choice is the presence of variability in the phenotype of males, at least in part related to genotypic variability. This requisite is clearly met in SES (Fabiani et al., 2004; see also Chapter 2 and 3). Two other pre-requisites of female choice are much less compatible with basic breeding biology and behaviour of SES. Firstly, females should be able to sample different males. In SES, free sampling is limited by female breeding pattern.. Females arrive on land and after a few days they give birth; once a female reaches an harem, her chance to move away to an other harem is limited by the active “herding” action of the harem holder (Galimberti et al., 2000a). Females have reduced mobility on land, and after parturition they don't move anymore, remaining in the same harem where they gave birth; most females (79% in my study population) give birth in the same harem they join just after arrival on land. The remaining females change harem one or more times before giving birth. Timing and pattern of these changes indicate that female are in fact choosing harems for their size, and not for males that hold them. After removal of the effect of harem size, there is no indication of any correlation between the phenotype of the harem holder and female preference (Galimberti et al., 2000b). Ownership of harems depends completely on males and their hierarchical ordering, and females have no part in this process. Therefore, sampling opportunities are very limited, usually to a single harem holder. Secondly, for inter-sexual selection to happen, females should have some control of the actual mating. Females tend to react aggressively to males on most mating attempts, but become receptive and, in most cases almost passive, after entering oestrus,

at the end of the lactation period. The behavioural reaction to male approaches is almost independent of male age or status. This pattern, combined with the huge sexual dimorphism in size that permits males to effectively herd females and obtain forced copulations (Galimberti et al., 2000a), results in an almost complete lack of control of females over mating. In the northern species, there is some evidence (Cox and Le Boeuf, 1977) that females indirectly choose mates by inciting male competition, reacting in a more aggressive way to non-harem holders approaches than to harem holders ones. This phenomenon of male competition incitation doesn't seem to happen in my study population (Galimberti et al., 2000b), nor in the Valdés Peninsula population of southern elephant seals (Galimberti, 1995).

I.3. Objectives of the research and thesis outline

The important role of vocalizations in male elephant seal behaviour was recognized early in the study of the species (Laws, 1956; Matthews, 1929), but little information on acoustic structure was available until very recently (Sanvito and Galimberti, 2000a). Most speculation about the function of vocalizations was based on casual observation on the NES (Bartholomew and Collias, 1962; Sandegren, 1976), and the matter was not tackled in any published paper on the SES, apart from anecdotal statements (McCann, 1981). I began my research on male SES acoustic communication by studying the acoustic structure (Sanvito and Galimberti, 2000a) and the individual variation of vocalizations (Sanvito and Galimberti, 2000b). The goal of my current research project was to go a step further, to understand the function(s) of male

vocalizations, to examine the importance of the different acoustics features, to explore their relationships with male phenotype, and to assess the potential use of vocalizations as honest signals.

The first problem I encountered was the lack of basic information about many aspects of SES biology that may be important for vocalization emission, and form the background on which a study of vocal communication should be staged. In particular, there was a notable lack of information on SES structural phenotypic traits, both for the Sea Lion Island population and at large. Moreover, there was almost no information on the anatomy of the elephant seal vocal tract. Therefore, I collected data on body size of breeding males, I estimated a post-puberty male growth curve, I measured secondary sexual traits, and in particular the proboscis, which is likely involved in sound emission, and I suggested a preliminary model of the SES vocal tract.

Body size has a pervasive effect on all aspects of the biology of most mammalian species (Reiss, 1989), and is a fundamental aspect of male elephant seal breeding biology. It affects the tenure and endurance of males during the breeding season (Deutsch, 1990), plays an important role in settlement of agonistic contests and in the establishment of social dominance relationships (Haley, 1994), and is related to mating success (Le Boeuf and Reiter, 1988). Moreover, the acoustic structure of vocalizations depends on the vocal tract, which is, in turn, related to body size (Fitch and Hauser, 2002). Unfortunately, scant information was available on male growth in SES (McLaren, 1993) at large, and none for the Sea Lion Island population. Therefore, I collected information on body size of male elephant seals using a photogrammetric method, and I carried out an in-depth analysis of growth (Chapter 2). My results demonstrate that, contrary to general belief, post-pubertal

growth of male elephant seals is almost linear, and shows few signs of an asymptote in the age span of the males of my sample, i.e., in the typical size range of breeding males. Moreover, the comparison of my data with information collected using a similar methodology in the Año Nuevo population of NES (Clinton, 1994), shows that the growth pattern in SES is quite different from NES. In the NES males, growth seems to stop much earlier than in the SES, and most of the body growth is completed during the first years after physiological breeding maturity. On the contrary, SES males carry on growing for longer, and most adult males, with the single notable exception of the oldest male of my study, present some growth even a few years after becoming resident harem holders. Therefore, in my study population there was a much larger difference in body size between young peripheral males and old harem holders than in the NES of Año Nuevo. This difference has deep implications for the structure of the mating system, and may explain why NES males are less effective than SES in monopolizing access to females and mating (Fabiani et al., 2004; Hoelzel et al., 1999). Due to the smaller difference in size with respect to peripheral males, NES harem holders may be less effective in both direct competition and endurance rivalry than their SES counterparts.

The proboscis is the most peculiar trait of male elephant seal morphology. It has been interpreted as an example of a secondary sexual trait since Darwin (1871), but its functions are unclear (e.g., its possible role in vocalization). Most statements on the role of the proboscis in the emission of sounds found in the literature were based on anecdotal evidence (McCann, 1981; Sandegren, 1976), and no quantitative data was available. Therefore, I used photogrammetry to measure the proboscis and other facial features of a large sample of Sea Lion Island males. In chapter 3, I describe the ontogeny and

allometry of the proboscis, and analyze current phenotypic selection pressures on the proboscis traits. Currently, in the Sea Lion Island population, the proboscis size is under positive sexual selection pressure, even when the effect of selection on whole body size is taken into account. My results show that proboscis size has a positive correlation with age and body size, and, therefore, can be used as a visual cue for assessment during agonistic contests. On the other hand, the relationship is clear only during the first years of the post-puberty development, while for mature males (age > 9 years) the relationship became blurred. Therefore, although the proboscis may have a role as visual signal, I suggest that the observed sexual selection pressure could be also, or more likely, the result of the function of the proboscis in the emission of agonistic vocalizations, a point that I further develop in Chapter 7.

An important, but often underrated, aspect of vocalizations is their macro-structure in the time domain. Most analyses of animal acoustic features, in particular bird vocalizations, focus on the frequency domain. This approach is certainly valid, in particular for species that show strong frequency modulation of sounds and, therefore, may code most information in the frequency domain. Elephant seals on the other hand, emit pulse trains with scarce frequency modulation, therefore I began my study of the acoustic features of male sounds with an in depth analysis of the time domain. In chapter 4, I consider the macrostructure of agonistic vocalizations, in particular in relation to vocal learning. The evidence for vocal learning in wild mammal populations is quite scarce, and there is almost no information on vocal development in individually recognized subjects. My results show that individual males at Sea Lion Island emit vocalizations with a specific temporal structure that is stable within individuals and

variable between them. The vocalizations of different individuals can be classified in a small number of discrete vocal types. My results also show that the proportions of the different vocal types changed over time during the eight breeding seasons of my study. Moreover, the most parsimonious explanation of the trends of increase or decrease of the different vocal types is a process of vocal imitation by the younger peripheral males, with older harem holders as models. Harem holders are the main component of the acoustic habitat of peripheral males during the breeding season. New vocal types spread in the population in consecutive breeding season if they belong to harem holders, while they disappear if they belong to unsuccessful individuals.

There is scanty information on the natural development of vocalization in mammals, because of the intrinsic difficulties involved in the longitudinal follow up of wild animals. In elephant seals, acoustic and behavioural features of vocalizations show gross differences between young and old males, but variation with actual age depends on the specific feature (Shiple et al., 1986). In principle, development of acoustic features that are independent of structural phenotype should show little or no relationship with age, because they are rather free to change in any direction. On the contrary, features that are constrained, because they depend on the vocal tract size and shape, should show a directional development with age, because of the age-specific development of the vocal tract, which has a gross relationship with body growth. In chapter 5, I analyze the ontogeny of vocalizations. My results show that formants, which are constrained by vocal-tract length and, therefore, by body size, show a decline in frequency with age, whereas temporal and structural features of sounds, which are potentially unconstrained, show no trend. Moreover, the age specific trend is more clear for upper formants, that are

expected to be more constrained by the vocal tract, than for lower formants, that are expected to be shaped by anatomical features that can be changed by the emitter. Formants ontogeny therefore seems to be mainly a product of body maturation. Hence, formants may be reliable signals of age that can be used for assessment during agonistic contests. On the contrary, simpler acoustics features, including temporal features and syllable structure, are free to vary independent of age and size and, hence, are poor candidates as channels for the transmission of reliable information about phenotype. On the other side, they may serve as raw material for vocal learning and individual recognition.

Most studies of vocalizations are concentrated on the frequency and time domain, while the intensity of sounds (or sound level, SL) is very rarely studied, possibly because of the intrinsic difficulties of obtaining reliable SL estimates in a field setting. Sound intensity is an important acoustic property that should be related to body size and, therefore, it is a potentially good candidate as a reliable signal of the emitter phenotype. In chapter 6, I present SL measurements collected with a direct stimulation method, that permits me to measure SL of wild elephant seals in standard conditions. I analyze repeatability and inter-individual variability of these SL measurements, their correlations with age and size, and their relationship to the breeding status. I also include some original data collected on NES males of the San Benitos Islands (Baja California, Mexico). SES males were significantly larger and produced more powerful vocalizations than NES males. My results show that SL is very repeatable and variable between individuals. Moreover, SL is related to age, body size, and breeding status of males of each species, although the relationships are somewhat weak. Therefore, although SL may

be an honest signal of gross differences in phenotype between males, it is not, by itself, a good candidate for the transmission of high-resolution information that can be used for assessment during agonistic contests.

A common assumption in the study of animal behaviour is that animals can transmit reliable information about their phenotype, being able to settle competitive contests without direct interactions and fights. This assumption has been tested rarely in wild mammal populations. Recently, some studies showed a relationship between acoustic features of male vocalizations and phenotype of the emitter, age and size in particular (Reby and McComb, 2003). In Chapter 7, I carry out a detailed analysis of the relationships between frequency features of vocalizations and various phenotypic traits in male SES of Sea Lion Island. I consider age, size, behavioural traits and summary indices of resource holding potential. I also analyze the relationships with the proboscis size and shape, and I suggest a preliminary model of the elephant seal vocal tract. My results show that the upper formants (4th and 5th in particular) and formant dispersion convey significant information about age, size and RHP, and therefore, can be honest indicators of phenotype. On the other hand, I show that the amount of variance in the phenotypic traits explained by variance in formants is not large even for upper formants and, therefore, that the effectiveness of formants as an acoustic assessment system in elephant seals is open to question.

Note to the appendices

I have frequently cited in the text of this and next chapters the following two articles, that form the basis of the current knowledge on acoustics of southern elephant seals:

- Sanvito S., Galimberti F., 2000 a. Bioacoustics of southern elephant seals. I. Acoustic structure of male aggressive vocalizations. *Bioacoustics*. 11:259-285.

- Sanvito S., Galimberti F., 2000 b. Bioacoustics of southern elephant seals. II. Individual and geographical variation in male aggressive vocalizations. *Bioacoustics*. 11:287-307.

The *Bioacoustics* journal may be of difficult access for some readers, so I made these two papers available for download as pdf files from the following websites:

http://www.eleseal.it/papers/bioa00_1.pdf

http://www.eleseal.it/papers/bioa00_2.pdf

Also, some examples of male elephant seal sounds are available for download from the following website:

http://www.eleseal.it/es_sounds.htm

I.4 LITERATURE CITED

- Andersson M., 1994. *Sexual selection*. Princeton: Princeton University Press.
- Badyaev A.V., Leaf E.S., 1997. Habitat associations of song characteristics in phylloscopus and hippolais warblers. *Auk*. **114**:40-46.
- Bartholomew G.A., 1970. A model for the evolution of pinniped polygyny. *Evolution*. **24**:546-559.
- Bartholomew G.A., Collias N.E., 1962. The role of vocalization in the social behaviour of the Northern Elephant Seal. *Animal Behaviour*. **10**:7-14.
- Beehler B.M., Foster M.S., 1988. Hotshots, hotspots, and female preference in the organization of lek mating systems. *American Naturalist*. **131**:203-219.
- Boarman W.I., 1990. Avian song ecology: the relationships between habitat acoustics and the vocal signal structure. *Behavioral Ecology and Sociobiology*. **26**:481-491.
- Boness D.J., 1991. Determinants of mating systems in the Otariidae (Pinnipedia). In: *Behaviour of Pinnipeds* (Renouf D. ed). London: Chapman and Hall; 1-44.
- Boyd I.L., 1998. Time and energy constraints in pinniped lactation. *American Naturalist*. **152**:717-728.
- Bradbury J.W., Vehrencamp S.L., 1998. *Principles of Animal Communication*. Massachusettes: Publishers. Sunderland.
- Braschi C., 2004. Comportamento agonistico negli elefanti marini del sud (PhD). Roma, Italy: University of Roma "La Sapienza".
- Campbell B., 1972. *Sexual selection and the descent of man*. Chicago: Aldine.

- Clinton W.L., 1994. Sexual selection and growth in male Northern Elephant Seals. In: *Elephant seals. Population ecology, behavior, and physiology* (Le Boeuf B.J., Laws R.M. eds). Berkeley (CA): University of California Press; 154-168.
- Clutton-Brock T.H., 1982. The functions of antlers. *Behaviour*. **79**:108-125.
- Clutton-Brock T.H., Albon S.D., 1979. The roaring of red deer and the evolution of honest advertisement. *Behaviour*. **69**:145-170.
- Cox C.R., Le Boeuf B.J., 1977. Female incitation of male competition: a mechanism of mate selection. *American Naturalist*. **111**:317-335.
- Darwin C., 1859. *On the origin of species by means of natural selection, or, the preservation of favoured races in the struggle for life*, 1 ed. London: John Murray.
- Darwin C., 1871. *The descent of man and selection in relation to sex*, 1 ed. London: John Murray.
- Dawkins R., Krebs J.R., 1979. Arms races between and within species. *Proceedings of the Royal Society Biological Sciences Series B*. **205**:489-511.
- Deutsch C.J., 1990. Behavioral and energetic aspects of reproductive effort of male northern elephant seals (*Mirounga angustirostris*) (Ph.D. Thesis). Santa Cruz (CA): University of California.
- Endler J.A., 1993. Some general comments on the evolution and design of animal communication systems. *Philosophical Transactions of the Royal Society of London B*. **340**:215-225.
- Fabiani A., Galimberti F., Sanvito S., Hoelzel A.R., 2004. Extreme polygyny among southern elephant seals at the Falkland Islands: behavioral estimates and genetic paternity. *Behavioral Ecology*. **15**:961-969.

- Fant G., 1960. *Acoustic Theory of Speech Production*: Mouton, The Hague.
- Fisher R.A., 1930. *The genetical theory of natural selection*, 1 ed. Oxford: Clarendon Press.
- Fitch W.T., 1997. Vocal tract length and formant frequency dispersion correlate with body size in rhesus macaques. *Journal of the Acoustical Society of America*. **102**:1213-1222.
- Fitch W.T., 2000. The Phonetic Potential of Nonhuman Vocal Tracts: Comparative Cineradiographic Observations of Vocalizing Animals. *Phonetica*. **57**:205-218.
- Fitch W.T., Hauser M.D., 2002. Unpacking "honesty": vertebrate vocal production and the evolution of acoustic signals. In: *Acoustic Communication* (Simmons A.M., Popper A.N., Fay R.R. eds). New York: Springer-Verlag.
- Fitch W.T., Reby D., 2001. The descended larynx is not uniquely human. *Proceedings of the Royal Society Biological Sciences Series B*. **268**:1669-1675.
- Fry D.B., 1979. *The physics of speech*: Cambridge Univ. Press.
- Galimberti F., 1995. Competizione tra i maschi e selezione sessuale nell' elefante marino del sud (Mirounga leonina) della Penisola di Valdés [Intermale competition and sexual selection in southern elephant seals (Mirounga leonina) of the Valdés Peninsula; in Italian, with English abstract] (PhD Thesis). Roma: Università degli Studi di Roma "La Sapienza".
- Galimberti F., Boitani L., Marzetti I., 2000a. The frequency and costs of harassment in southern elephant seals. *Ethology Ecology & Evolution*. **12**:345-365.
- Galimberti F., Boitani L., Marzetti I., 2000b. Female strategies of harassment reduction in southern elephant seals. *Ethology Ecology & Evolution*. **12**:367-388.

- Galimberti F., Fabiani A., Boitani L., 2003. Socio-spatial levels in linearity analysis of dominance hierarchies: a case study on elephant seals. *Journal of Ethology*. **21**:131-136.
- Galimberti F., Fabiani A., Sanvito S., 2002. Measures of breeding inequality: a case study in southern elephant seals. *Canadian Journal of Zoology*. **80**:1240-1249.
- Geist V., 1974. On fighting strategies in animal conflict. *Nature*. **250**:354.
- Geist V., 1986. New evidence of high frequency of antler wounding in cervids. *Canadian Journal of Zoology*. **64**:380-384.
- Guilford T., Dawkins M.S., 1995. What are conventional signals? *Animal Behaviour*. **49**:1689-1695.
- Haley M.P., 1994. Resource-holding power asymmetries, the prior residence effect, and reproductive payoffs in male northern elephant seal fights. *Behavioral Ecology and Sociobiology*. **34**:427-434.
- Harper D.G.C., 1991. Communication. In: *Behavioural ecology. III edition*. (Krebs J.R., Davies N.B. eds). Oxford: Blackwell; 374-397.
- Hoelzel A.R., Le Boeuf B.J., Reiter J., Campagna C., 1999. Alpha-male paternity in elephant seals. *Behavioral Ecology and Sociobiology*. **46**:298-306.
- Hopp S.L., Owren M.J., Evans C.S., 1998. *Animal acoustic communication. Sound analysis and research methods*. New York: Springer-Verlag Berlin Heidelberg.
- Irwin R.E., 1996. The phylogenetic content of avian courtship display and song evolution. In: *Phylogenies and the comparative method in animal behavior* (Martins E.P. ed). Oxford: Oxford University Press; 234-252.

- Jennings D.J., Gammell M.P., Carlini C.M., Hayden T.J., 2003. Is the parallel walk between competing male fallow deer, *Dama dama*, a lateral display of individual quality? *Animal Behaviour*. **65**:1005-1012.
- Johnstone R.A., 1997. The evolution of animal signals. In: *Behavioural ecology. An evolutionary approach. 4th edition*. (Krebs J.R., Davies N.B. eds). Oxford: Blackwell; 155-178.
- Krebs J.R., Davies N.B., 1978. Animal signals: information or manipulation? In: *Behavioural ecology, 1st edition* (Krebs J.R., Davies N.B. eds). Oxford: Blackwell Scientific Publications; 380- 402.
- Krebs J.R., Dawkins R., 1984. Animal signals, mind-reading and manipulation. In: *Behavioural ecology, 2nd edition* (Krebs J.R., Davies N.B. eds). Oxford: Blackwell Scientific Publications; 380- 402.
- Laws R.M., 1956. The elephant seal (*Mirounga leonina* Linn.). II. General, social, and reproductive behaviour. *Scientific Reports of the Falkland Island Dependencies Surveys*. **13**:1-88.
- Le Boeuf B.J., Laws R.H., 1994. *Elephant seals. Population ecology, behavior and physiology*, 1 ed. Berkeley, CA: University of California Press.
- Le Boeuf B.J., Reiter J., 1988. Lifetime reproductive success in northern elephant seals. In: *Reproductive success. Studies of individual variation in contrasting breeding systems* (Clutton-Brock T.H. ed). Chicago: University of Chicago Press; 344-362.
- Lindfors P., Tulleberg B.S., Biuw M., 2002. Phylogenetic analyses of sexual selection and sexual size dimorphism in pinnipeds. *Behavioral Ecology and Sociobiology*. **52**:188-193.

- Mateos C., 1998. Sexual selection in the ring-necked pheasant: a review. *Ethology Ecology and Evolution*. **10**:313-332.
- Matthews L.H., 1929. The natural history of the elephant seal, with notes on other seals found at South Georgia. *Disc. Rep.* **1**:233-256.
- Maynard Smith J., Harper D.G.C., 1988. The evolution of aggression — can selection generate variability? *Philosophical Transactions of the Royal Society of London B*. **319**:557-570.
- McCann T.S., 1981. Aggression and sexual activity of male Southern elephant seals, *Mirounga leonina*. *Journal of Zoology London*. **195**:295-310.
- McElligott A.G., Hayden T.J., 1999. Context-related vocalization rates of fallow bucks, *Dama dama*. *Animal Behaviour*. **58**:1095-1104.
- McLaren I.A., 1993. Growth in pinnipeds. *Biological Reviews*. **68**:1-70.
- Miller E.H., 1991. Communication in pinnipeds, with special reference to non-acoustic signalling. In: *The behaviour of the Pinnipeds* (Renouf D. ed). London: Chapman and Hall; 128-235.
- Modig A.O., 1996. Effects of body size and harem size on male reproductive behaviour in the southern elephant seal. *Animal Behaviour*. **51**:1295-1306.
- Müller J., 1848. *The physiology of the senses, voice and muscular motion with the mental faculties*. London: Walton and Maberly.
- Reby D., Cargnelutti B., Hewison A.J.M., 1999. Contexts and possible functions of barking in roe deer. *Animal Behaviour*. **57**:1121-1128.
- Reby D., McComb K., 2003. Anatomical constraints generate honesty: acoustic cues to age and weight in the roars of red deer stags. *Animal Behaviour*. **65**:519-530.

- Reiss M.J., 1989. *The allometry of growth and reproduction*, 1 ed. Cambridge: Cambridge University Press.
- Rendall D., Kollias S., Ney C., 2005. Pitch (F0) and formant profiles of human vowels and vowel-like baboon grunts: The role of vocalizer body size and voice-acoustic allometry. *Journal of the Acoustical Society of America*. **117**:944-955.
- Rubin P., Vatikiotis-Bateson E., 1998. Measuring and modelling speech production. In: *Animal acoustic communication. Sound analysis and research methods* (Hopp O., Evans Eds. ed). New York: Springer-Verlag Berlin Heidelberg; 251-290.
- Sandegren F.E., 1976. Agonistic behavior in the male Northern Elephant seal. *Behaviour*. **57**:136-158.
- Sanvito S., Galimberti F., 2000a. Bioacoustics of southern elephant seals. I. Acoustic structure of male aggressive vocalizations. *Bioacoustics*. **11**:259-285.
- Sanvito S., Galimberti F., 2000b. Bioacoustics of southern elephant seals. II. Individual and geographical variation in male aggressive vocalizations. *Bioacoustics*. **11**:287-307.
- Shipley C., Hines M., Buchwald J.S., 1986. Vocalizations of northern elephant seal bulls: development of adult call characteristics during puberty. *Journal of Mammalogy*. **67**:526-536.
- Tinbergen N., 1952. "Derived" activities; their causation, biological significance, origin and emancipation during evolution. *Quarterly Review of Biology*. **27**:1-32.
- Titze I.R., 1994. *Principles of voice production*. Englewood Cliffs: Prentice hall.
- Trivers R.L., 1972. Parental investment and sexual selection. In: *Sexual selection and the descent of man* (Campbell B. ed). Chicago: Aldine; 139-179.

- Weckerly F.W., 1998. Sexual-size dimorphism: Influence of mass and mating systems in the most dimorphic mammals. *Journal of Mammalogy*. **79**:33-52.
- Wiley R.H., 1983. The evolution of communication: information and manipulation. In: *Animal Behaviour, Vol. 2: Communication* (Halliday T.J., Slater P.J.B. eds). New York: W. H. Freeman; 156-189.
- Wiley R.H., Richards D.G., 1978. Physical constraints on acoustic communication in the atmosphere: implications for the evolution of animal vocalizations. *Behavioral Ecology and Sociobiology*. **3**:69-94.
- Williams G.C., 1966. *Adaptation and natural selection. A critique of some current evolutionary thought*. Princeton: Princeton University Press.
- Wilson E.O., 1975. *Sociobiology. The new synthesis*. Cambridge (MA): Belknap Press.
- Zahavi A., 1993. The fallacy of conventional signalling. *Philosophical Transactions of the Royal Society of London B*. **340**:227-231.

II - Body size and growth in male elephant seals

(To be submitted to *Journal of Zoology London*)

II.1 ABSTRACT

Body size is a fundamental aspect of male elephant seal breeding biology, affecting endurance, dominance and mating success. Due to their large size (mean standard body length = 408 cm), estimation of body size and growth rates of male elephant seals is not easy. I used a photogrammetric method to determine body size in a large sample of southern elephant seal males. I estimated post-puberty growth, showing that, in the age span of the males of my sample (5-16 years of age), growth in length was almost linear, and showed no sign of an asymptote. I compared my data with growth estimates of other populations, and with the northern elephant seals. I show that the pattern of growth of males of the two species is rather different, with NES stopping to grow at late ages, while SES keeping to grow from the whole lifespan, and that this difference may explain the differences in male tactics and distribution of male breeding success.

II. 2 INTRODUCTION

Body size is a crucial component of animal biology, because of the pervasive effect of scaling on almost all biological processes (Schmidt-Nielson, 1984). Growth curves are not only a key tool to study life history evolution (Roff, 1992) and to understand the differences in body size between sexes and among populations and species (Calder, 1984), but also have applied relevance (Garlich-Miller and Stewart, 1998; McLaren, 1993). The two species of elephant seals (genus *Mirounga*) are routinely proposed as extreme examples of male competition for mates and sexual selection (Andersson, 1994). The strong grouping tendency of elephant seal females and the harem-based mating system (Le Boeuf and Laws, 1994) produce strong competition among males and high potential for intra-sexual selection. Body size is a crucial component of male competitive success, being related to the likelihood to win a fight (Haley, 1994; Le Boeuf, 1974; McCann, 1981) and to the capability to sustain prolonged fasting during the breeding season (Deutsch, 1990; Galimberti et al., submitted). Body size and growth also play important roles in the evolution of elephant seal communication, being related to sound emission, communication of resource-holding potential (RHP), and honest signalling (Sanvito and Galimberti, 2003). Notwithstanding the important role of body size in male elephant seal breeding biology, available information on size and growth is scarce, particularly in comparison with females.

McLaren (1993) reviewed body size and growth of pinnipeds. He used two main sources of information for male southern elephant seals (*M. leonina*): from South Georgia (Laws, 1953) and from Macquarie Island (Carrick et al., 1962). This scarcity of data

reflects the difficulty in measuring live male elephant seals in natural settings (Deutsch, 1990). Methods of photogrammetry can ameliorate this problem, as they permit body-size estimates on unrestrained seals (Bell et al., 1997; Haley et al., 1991). Standardized and calibrated photographs enable estimation of body length and mass. Such methods are easy to implement in the field and, because they are non-invasive, are preferred on ethical grounds. Photogrammetry has been used to measure body size of male northern elephant seals (*M. angustirostris*) and of females plus young males of the southern species (Bell et al., 1997). However, a quantitative assessment of the method's reliability is lacking.

In this paper I use photogrammetry to estimate body size of male southern elephant seals. I present longitudinal data on post-pubertal growth of males on Sea Lion Island (Falkland Islands), calculate an operational relationship between body length and body mass, and compare my findings with northern elephant seals and other populations of southern ones.

II.3 METHODS

Data were collected during 9 breeding seasons (September-November, 1995 to 2003) at Sea Lion Island (Falkland Islands; SLI hereafter), which shelters a small and localized population of southern elephant seals (Galimberti et al., 2001), comprising about 550 females and 60 breeding males (plus 1 to 50 non breeding/moulting males, which haul out in different places from the breeding ones, depending on the time of the season). All males were individually recognized, because they were marked with two cattle tags (Jumbo Rototags, Dalton Supplies Ltd., www.dalton.co.uk). Rate of tag loss (estimated

from a double-tagging experiment assuming independent loss of each tag) was low (mean probability to lose both tags = 0.25%; Galimberti and Boitani, 1999). All breeding males also were marked with hair dye in each breeding season to permit rapid recognition without disturbing animals.

II.3.1 Estimation of age

Age was known for males tagged as pups (N = 23) and was estimated ± 1 year for other males using external features (Clinton, 1994; Galimberti and Boitani, 1999). I placed males in 6 age categories based on scarring of the chest and development of the proboscis, independently of body size (*i.e.* overall body size was not considered as an indicator of age for the purpose of age classification). Categories went from old juvenile (JUV3 = 5 years old) to sub-adults (from SAM1 to SAM4 = 6 to 9 years old) and adults (AD = 10 years old or older).

I checked my age classification using three criteria: intra-observer reliability, inter-observer reliability, and correspondence with actual age. Reliability was calculated using the Kendall coefficient of concordance, a rank-based measure of agreement (Siegel and Castellan, 1988), using data on marked males from a random sample of 10 daily censuses carried out during the 3-week period around the peak of the breeding season. Mean intra-observer reliability was 0.95 for various observers and inter-observer reliability ranged from 0.93 to 0.99 for 2 to 4 observers. Overall congruence was checked using lifetime records of the males that were present for 3 or more breeding seasons, and by comparing age categories to actual age for males tagged at birth. In analysis where age was involved, I only used males for which I knew the true age or that had been observed

during at least three consecutive breeding seasons (see also Clinton, 1994).

II.3.2 Estimation of body size

Body length and mass were estimated using photogrammetry (Bell et al., 1997; Haley et al., 1991) which permits body-size estimation without restraint and with little disturbance. The method requires the animals to lie on a flat solid surface and to be straight. Hence the technique is best applied on sandy beaches, the only breeding habitat of elephant seals on SLI (Galimberti and Boitani, 1999). Photographs were taken opportunistically when animals were in appropriate postures, or after moving animals by slowly walking toward them. One observer approached the subject from the caudal direction and held a 4-m-long calibrated surveying pole (Model 406 BIS/D – Salmoiraghi Strumenti Spa, Milano, Italy - <http://www.salmoiraghistrumenti.it>) parallel to the substrate and above the animal's midline. A second observer checked alignment from the cranial end, then took photographs from the side, from a distance of 10 to 20 m, with the camera 50 to 100 cm above the ground. The camera was aligned on the centre of the body, and was kept parallel to its longitudinal axis, to avoid perspective distortion of the pictures. For each session, several series of photographs were taken, with the camera's distance and angle from animal varied slightly, checking the alignment, and eventually adjusting the position of the animal. Measurements from the same series were averaged, and only measurements from a series in which the animal significantly changed position were considered to be independent estimates of size. Photographs were taken with a Canon EOS1 SLR camera fitted with a 35-70 mm lens and Agfa 100 ASA black and white negatives, or with Canon PowerShot D20 digital camera working at the highest resolution (3.1 Megapixels). Black

and white negatives were scanned at high resolution as TIFF files, while the digital photographs were converted from JPEG to TIFF format (3072 x 2048 pixels). Brightness and contrast were regulated to facilitate measurement. All processing of photographs was carried out using Photoshop software (version 7, Adobe Inc.).

Measurements were made with Object Image software (<http://simon.bio.uva.nl/object-image.html>), using the pole included in each photograph as scale. To standardize protocol and to minimize biases due to perspective distortion, I always used 1 m of the pole, over the middle of the animal as the scale (Sanvito and Galimberti, 2003) (Figure II.1). This is very important, as the choice of a scale not centred on the animal to be measured, may greatly alter photogrammetric size estimates. The distortion caused by the camera plus lenses was checked by taking pictures of static objects of known length comparable to elephant seals' length, which were then measured with the same protocol described above. The distortion was negligible when using 1 m of the pole centred over the middle of the object as scale. Body length (cm) was measured from the beginning of the trunk to the point where the fore flippers attach to the rest of the body (Figure II.1; see also Haley et al. 1990).

Photogrammetric length (L) is about 91% of standard body length (SBL, or straight-line nose-to-tail length, American Society of Mammalogists, 1967): this is due to the fact that nose and tail are omitted from the photogrammetric measurement. Height was measured perpendicular to the substrate, where the back of the male is highest. The side outline of the animal was traced, and its area was measured, using Object Image software (see also Haley et al., 1991). Attention was put in avoiding measuring the side area in photographs where the substrate had depressions or bumps. Body mass (kg) was estimated from area

using the formula of Haley et al. (1991: Table 1), originally calculated for northern elephant seals, since male southern and northern elephant seals differ in size but are very similar in shape (Le Boeuf and Laws, 1994). In the mentioned study males were weighed using a weighing platform mounted on load cells, and body weight was regressed on various combination of photogrammetric measures. Side area was the best single photogrammetric predictor of actual weight. The combination of side area and other photogrammetric measures only slightly improved the prediction of body weight over side area alone. Altogether the authors endorsed side area only as the most effective photogrammetric estimator of body weight. Initial mass upon arrival on land was calculated using a correction equation estimated from date of arrival and rate of mass loss (Galimberti et al., submitted). Absolute growth in L was calculated as the difference in L between 2 consecutive breeding seasons ($L_2 - L_1$), while relative growth was calculated as per cent $(L_2 - L_1)/L_1$.

I collected 275 independent measurements of size for males of known age. In total, 200 males were measured in 1-6 breeding seasons (mean = 1.5 ± 0.8 seasons; 1 male for 6 seasons, 1 male for 5, 5 males for 4, 16 males for 3, 53 for 2, and 124 for 1). Therefore, the database is a mixture of cross-sectional and longitudinal data, with a prevalence of single records and just 11.5% of males with 3 or more measurements. A mean of 34.3 ± 17.4 males were measured in each year, and the number of males measured per year varied for logistic reasons. For example, only 8 males were measured in 1998 and 12 in 1999. Initial body mass was estimated for 35 males of known age in 2002 and 40 in 2003. Mean repeatability (Lessells and Boag, 1987) of photogrammetric length in the full data set (1995-2003, 1391 measures) was 0.941.

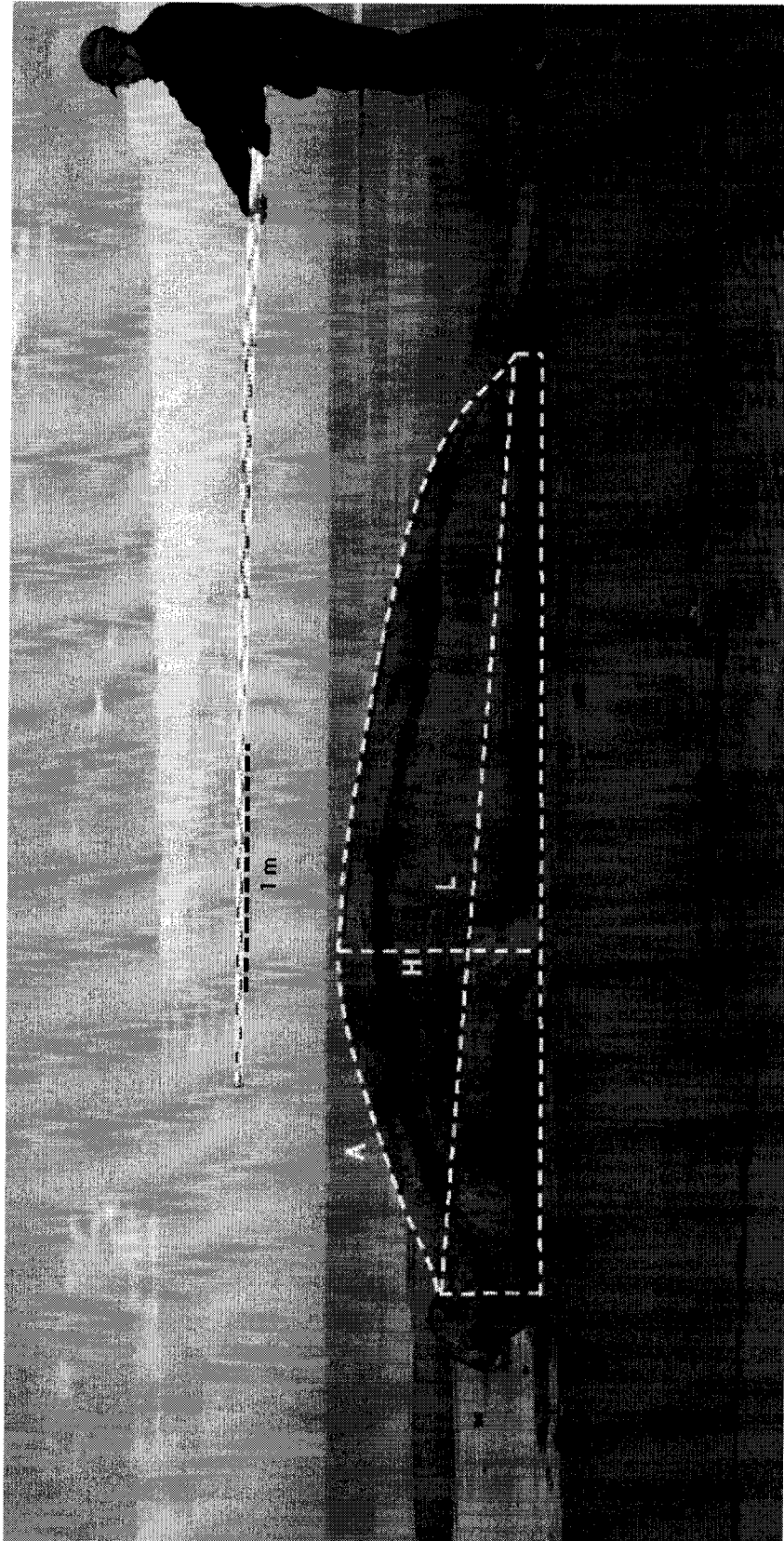

Figure II.1 – Photograph of an adult male elephant seal during a photogrammetric session. “1 m”: 1 m long portion of the calibrated pole used as scale; L = length; H = height; A = side area.

II.3.3 Statistics and modelling of growth

I present statistics as mean \pm standard deviation and least-squares estimates as estimate \pm standard error (se). Male elephant seals have a spurt in body growth, with a large increase in growth rate after puberty (Clinton, 1994; Laws, 1953), a common phenomenon in polygynous land-breeding pinnipeds (McLaren, 1993; but see Garlich-Miller and Stewart, 1998). Therefore, it is customary to fit two-component curves to male growth data (Koops, 1986). The use of two-phase curves not only permits a better fit, but is also more reasonable on theoretical ground (Day and Taylor, 1997). My study was focused on post-pubertal breeding males only, with an age range from 5 to 16 yr, and just 3 males younger than 6 years. Therefore, almost all males were older than the age of the growth spurt (Clinton, 1994), and I used single-component curves to model my data. I fitted 3 equations of the sigmoidal family of curves related to the generalized Richards curve (Fitzhugh, 1975):

Logistic curve

$$Length = \frac{A}{1 + be^{-kAge}}$$

Gompertz curve

$$Length = Ae^{-be^{-kAge}}$$

Three parameters von Bertalanffy curve (= Brody curve)

$$Length = A(1 - be^{-kAge})$$

The main parameters are A, which is the asymptotic length, and k, which determines the reduction in growth rate as age increases (b is a time-scaling factor not relevant from a biological point of view). Growth curves were fitted using the non-linear least-squares module of SYSTAT software (version 10, Systat Inc.). Fitting was carried out using a least-squares loss function and the Levenberg-Marquardt algorithm. Asymptotic standard errors were checked using bootstrap; due to the similarity between estimates of asymptotic and bootstrapped se I present only the former. Models were compared using the corrected Akaike information criterion (AIC); a difference in AIC equal to or greater than 2 gives moderate evidence that the model with the lower AIC should be preferred, while a difference ≥ 7 gives compelling evidence (Burnham and Anderson, 1998). Data exploration, calculation of measurement error and repeatability, mixed models fitting, and randomization tests were carried out using Stata software (version 7, Stata Corporation). The number of re-samplings used in randomization tests is stated as a subscript of the “p” label; the observed value of the statistic was included in the re-sampled statistics (Manly, 1997).

II.4 RESULTS

II.4.1 Estimation of an operational length-mass relationship

To check linearity of the relationship between estimated length and mass I fitted a cubic spline with smoothing parameter estimated by cross-validation (Schluter et al., 1998). The spline showed no sign of deviation from a simple linear pattern (Figure II.2).

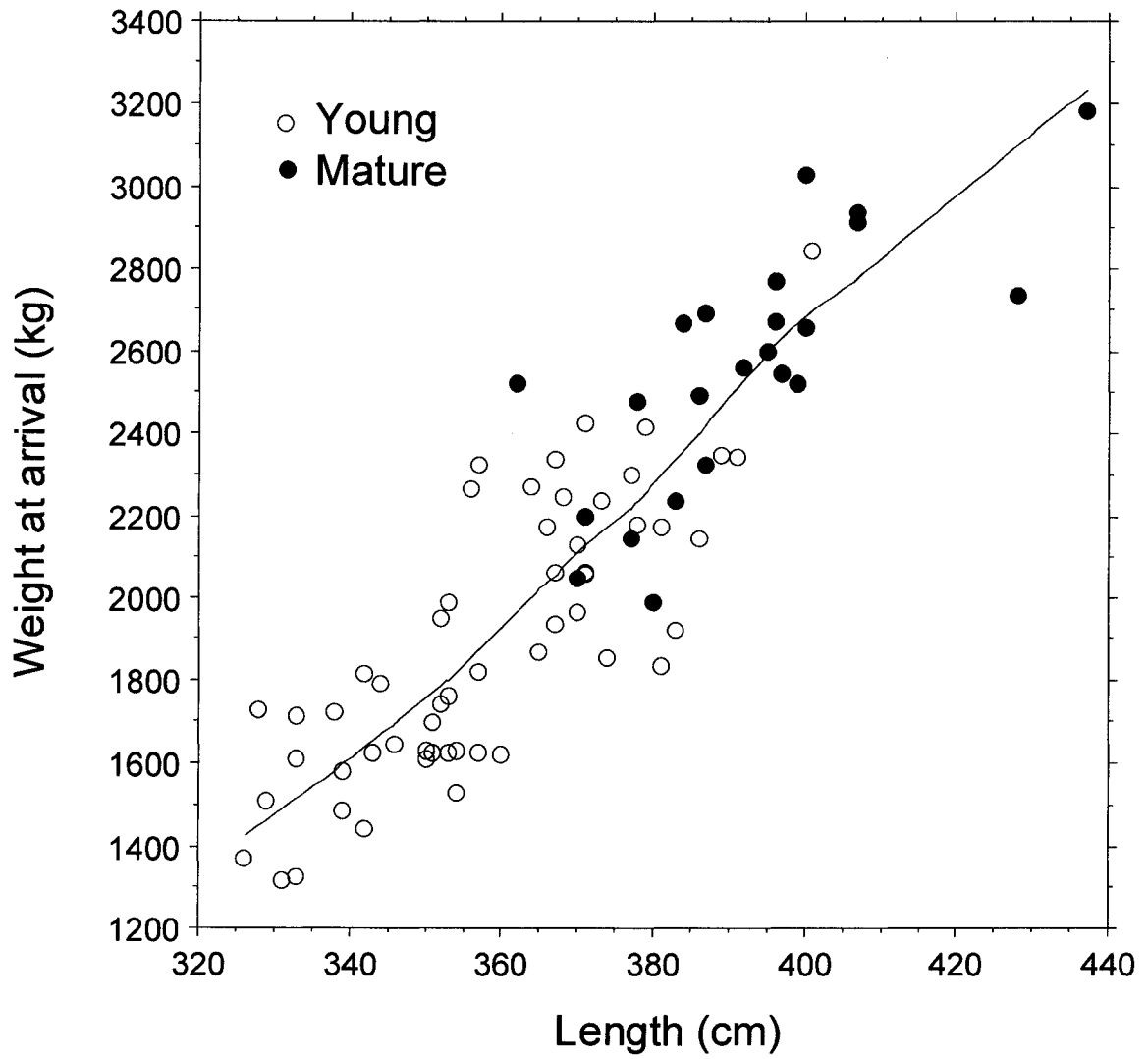

Figure II.2 – Relationship between body length and body weight in male SES at SLI. The continuous line represents a cubic spline fitted through the data. Young males represented as circles and mature ones as filled circles.

The following simple linear regression explained 79.5% of variance in mass:

$$\text{Mass} = -4077.05 + 16.84 \text{ Length}$$

The 95% CI of slope was 14.85-18.83. The slope of the relationship was homogeneous between 2002 and 2003 (Chow test: $F_{1,74} = 0.03$, $p = 0.87$).

II.4.2 Age-related variation in size (Table II.1)

Excluding the 5 males ≥ 14 yr of age, length was symmetric and normally distributed (Shapiro-Wilk test: $W = 0.992$, $p = 0.1408$). Mean length in the whole sample was 370.5 ± 28.3 cm. Photogrammetric length represents 91% of the standard body length, therefore, mean estimated SBL of breeding males across the 9 years was approximately 408 cm (maximum 501). For males < 14 yr of age, length increased in an approximately linear pattern (Figure II.3a). Mass at the beginning of the breeding season also was symmetric and normally distributed (Shapiro-Wilk test: $W = 0.976$, $p = 0.1620$). Mean body mass was 2107 kg, spanning from 1316 to 3182 kg. Mass increased almost linearly between ages 6 and 12 (Figure II.3b). Absolute and relative growth rates were calculated for 67 males over 2-6 years. Both measures decreased with age, but a weak growth was evident even around 15 years, although the samples after age 13 were very small, and standard error of estimates very large (Table II.2).

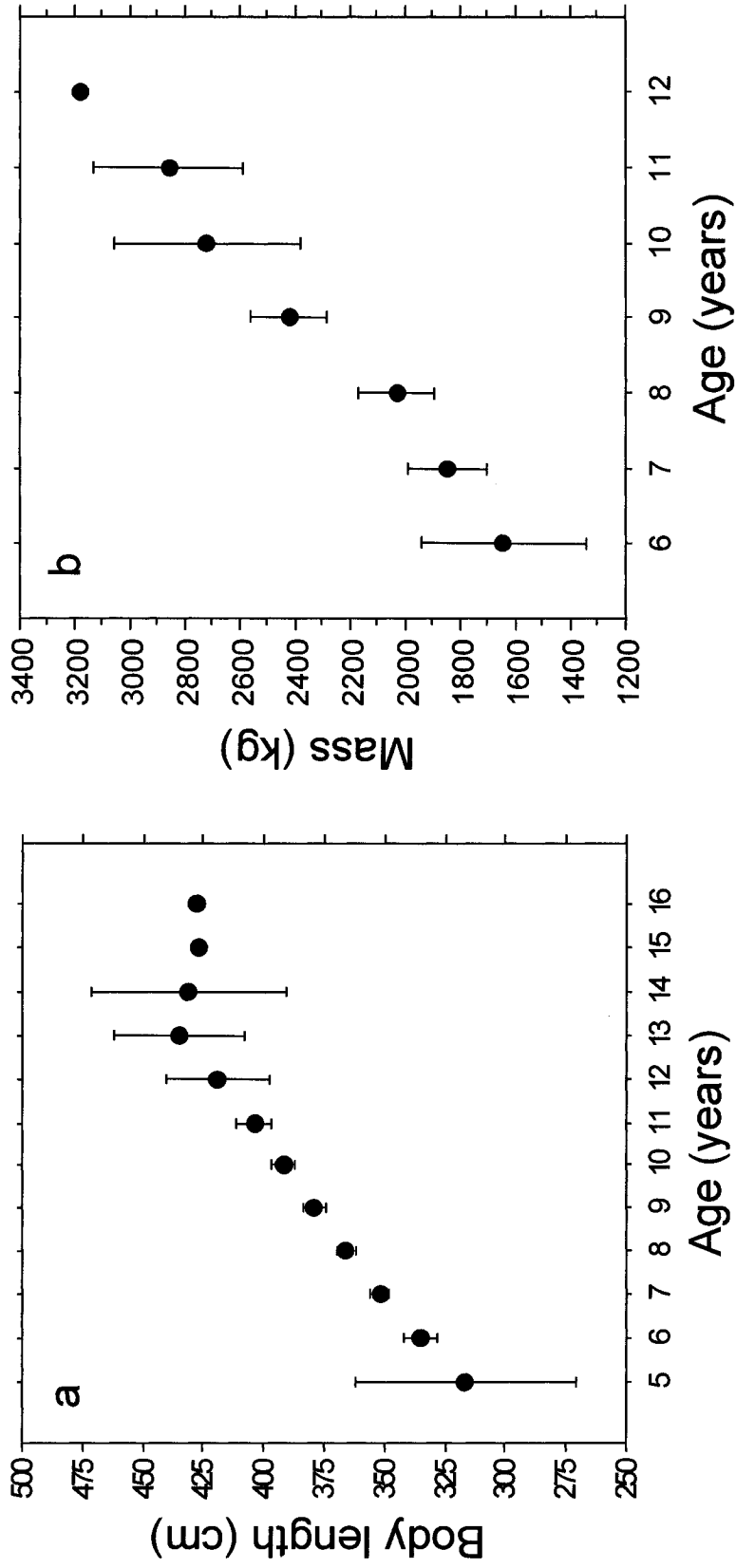

Figure II.3 – Observed growth in body length (a) and mass (b) of SLI male elephant seals. Mean \pm standard error.

Table II.1 - Body length (cm) and mass (kg) of different age classes of male southern elephant seals.

Age	Body length				Body mass			
	n	Mean \pm SD	Min	Max	n	Mean \pm SD	Min	Max
5	3	316.7 \pm 18.34	296	331				
6	20	335.1 \pm 15.37	305	366	7	1645.0 \pm 321.68	1369	2326
7	65	351.8 \pm 16.71	310	391	21	1848.1 \pm 306.65	1316	2345
8	69	366.2 \pm 15.77	333	406	24	2028.9 \pm 327.49	1487	2844
9	45	379.1 \pm 15.13	344	405	15	2422.8 \pm 247.49	1990	2769
10	33	391.6 \pm 13.59	369	421	4	2719.3 \pm 214.88	2524	3026
11	21	404.0 \pm 15.51	369	437	3	2859.3 \pm 109.32	2734	2935
12	9	419.0 \pm 27.57	366	453	1	3182.0	3182	3182
13	5	435.0 \pm 21.78	403	456				
14	3	431.0 \pm 16.37	417	449				
15	1	427.0						
16	1	428.0						

Table II.2 - Absolute (cm) and relative (%) growth in different male age classes of southern elephant seal

Age	Absolute Growth					Relative growth			
	N	Mean \pm SD	SE	Min	Max	Mean \pm SD	SE	Min	Max
6	11	25.9 \pm 13.07	3.94	6	46	7.95 \pm 4.16	1.26	1.54	13.73
7	38	19.6 \pm 11.70	1.90	3	46	5.71 \pm 3.63	0.59	0.82	13.73
8	43	18.2 \pm 10.36	1.58	3	44	5.18 \pm 3.10	0.47	0.82	13.37
9	37	17.3 \pm 10.07	1.66	4	44	4.73 \pm 2.86	0.47	1.01	12.05
10	33	17.2 \pm 10.74	1.87	4	44	4.62 \pm 2.92	0.51	1.01	12.05
11	21	14.3 \pm 10.48	2.29	1	37	3.64 \pm 2.71	0.59	0.25	9.25
12	12	9.8 \pm 7.83	2.26	1	23	2.44 \pm 1.95	0.56	0.24	5.60
13	7	6.4 \pm 5.16	1.95	1	13	1.60 \pm 1.39	0.52	0.24	3.50
14	3	5.3 \pm 7.57	4.37	0	14	1.49 \pm 2.19	1.26	0.00	4.00
15	5	9.2 \pm 7.95	3.56	0	15	2.43 \pm 2.11	0.94	0.00	4.01
16	1	1.0				0.23			

II.4.3 Growth curves

The best fit was obtained using the logistic model (Figure II.4), although differences between the models were small and corrected AIC estimates were equal (Table II.3), as frequently happens with pinniped length data (Clinton, 1994; Garlich-Miller and Stewart, 1998).

In all cases, the adjusted R^2 was low, residual mean square high, and asymptotic standard errors of the parameters large, indicating quite poor fits. Residuals were normally distributed and homogeneous for males < 14 yr of age and the poor fit was due mainly to high variation within age classes. The correlation matrix of fitted parameters showed high correlations for all models, in particular for the b and k parameters (> 0.80), which indicates over-parameterization (Norusis, 1994). For most of the age span covered by my data, and excluding the few individuals with age greater than 13 years, the variation of length with age was almost linear, as confirmed by fitting a cubic spline with smoothing parameter calculated by cross-validation, that showed a modest bending only after age 12. Therefore, I fitted a simple linear regression ($b = 13.50$, $se = 0.58$, $95\% \text{ ci} = 12.36\text{-}14.65$; adjusted $R^2 = 0.667$, corrected AIC = 1502.2), that had a smaller AIC than all the exponential curves, with a difference in AIC between this model and the logistic curve of 31.7, a clear indication that the linear model fitted the data better. My data was a mixture of cross-sectional and longitudinal data. To examine the effect of the longitudinal component, I fitted a linear mixed model, with male identity as random effect. The slope of this model was very similar to the simple regression ($b = 13.74$, $se(b) = 0.57$; $95\% \text{ ci} = 12.62\text{-}14.86$; adjusted $R^2 = 0.668$). A Lagrange multiplier test showed that the variance component due to within individual effect was significant ($\chi^2 = 59.7$, $df = 1$, $p < 0.0001$).

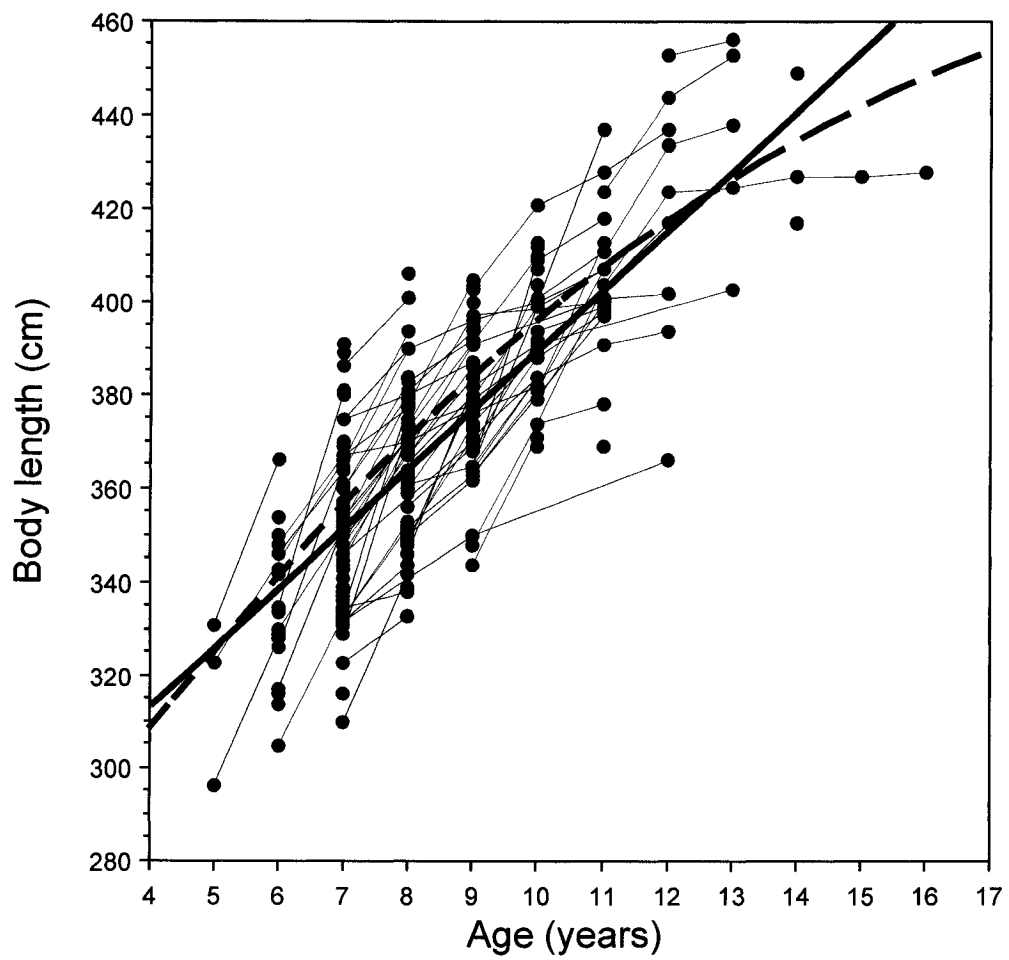

Figure II.4 - Growth of individual males, and fitted growth models. Thin lines connect size estimates of marked individuals; bold continuous line is linear regression; bold dashed line is the logistic model (see Table II.3).

Table II.3 - Growth curves fitted for body length. R²: coefficient of determination; AIC: corrected Akaike information criterion; CI = 95% asymptotic confidence interval

Model	R ²	AIC	A	CI(A)	k	CI(k)	b	CI(b)
Logistic	0.689	1533.9	489.1	432.4-545.8	0.157	0.092-0.222	1.178	1.038-1.318
Gompertz	0.689	1534.1	503.6	430.4-576.8	0.123	0.059-0.188	0.855	0.771-0.939
Brody	0.689	1534.3	526	422.3-629.7	0.090	0.026-0.154	0.623	0.573-0.672

Therefore, my final model for elephant seal growth in the 6-14 age range was:
Length = 255.07 + 13.74 Age.

II.5 DISCUSSION

II.5.1 The shape of southern elephant seal growth

It is customary to fit pinniped growth data with curves of the exponential family derived from the generalized Richards curve (Fitzhugh, 1975), assuming a gradual decrease in growth rate and existence of an asymptote (McLaren, 1993). In various areas of biology there is a persistent tendency to apply an *a priori* protocol of analysis without first looking at the data (e.g., allometric analysis, Smith, 1980). The simple linear model fitted to SLI growth data is not only more parsimonious, but is also to be preferred on statistical grounds, at least in the age range that I was able to study, confirming the absence of an age-specific reduction in growth rate and of a clear asymptote. There are only two other published sets of information on male elephant seal growth. Carrick et al. (1962) presented information on dorsal straight line length of males from Macquarie Island. A visual inspection of the available data shows no clear sign of a decelerating curvilinear relationship. Unfortunately, most estimates of adult or older sub-adult males presented in this study were “made by eye”, were non reliable and, therefore, did not permit the proper fitting of models (see also McLaren, 1993). Laws (1953) presented information on dorsal curvilinear length of males from Signy Island and South Georgia. This data set comprises many more measures which are of better quality, although it lacks, like my set, a good

coverage of late ages. I extracted data from Table XIII of Laws (1953) and I fitted two models, a simple linear model and an exponential curve; to simplify comparison, I choose the same generalized von Bertalanffy curves used by McLaren (1993) to fit this data set and data from most pinniped species. For males ≥ 6 yr of age, the fit of the linear model (AIC = 786.61) was better than the fit of the curvilinear model (AIC = 789.02) and, therefore, although the difference in AIC was small (2.41), the former model should be preferred. This result confirms that, in the age span for which data are available, there are scarce signs of a deceleration in male growth rate, contrary to what happens for females (McLaren, 1993) and for northern elephant seal males (Clinton, 1994), whose growth curve clearly show an asymptote.

II.5.2 Comparison with the northern elephant seal

The comparison with northern species showed an interesting difference. Sea Lion Island males showed high absolute and relative growth rates until 10 yr of age, and after that growth continued consistently (Figure II.5). In contrast, northern elephant seals (Clinton, 1994, Table 9.4) grow more slowly at any age class, and exhibit a pronounced reduction in growth rate with age, with almost no growth after 10 yr of age. Differences between the species were significant both for absolute (paired t-test with randomization: mean difference = 8.4 cm, $n = 7$, $t = 3.30$, $P_{10k} = 0.0150$) and relative growth (mean difference = 2.2 %, $n = 7$, $t = 3.36$, $P_{10k} = 0.0130$).

Males of the two species share a common timing of breeding: they achieve physiological maturity at about the same age, and at the same age begin to haul out on land during the breeding season, gradually increasing their involvement in the breeding activity (Le Boeuf and Laws, 1994), but due to the differences in growth, the distribution

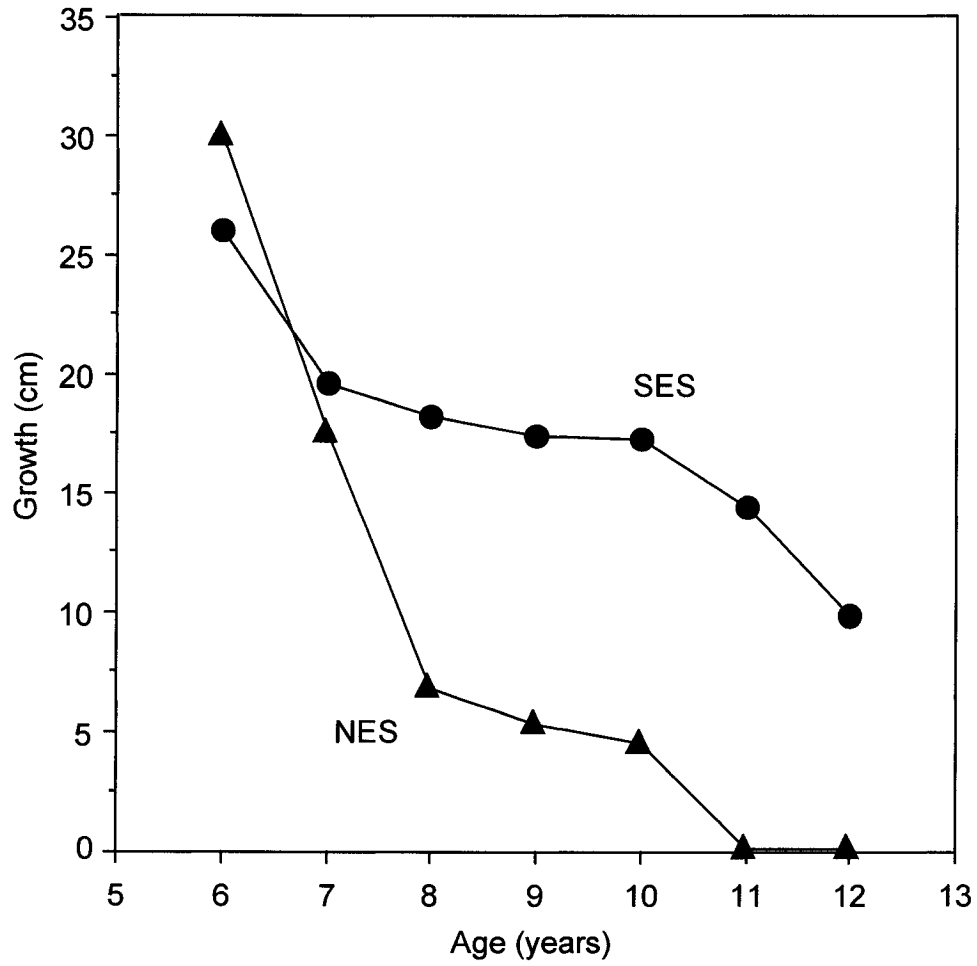

Figure II.5 – Absolute growth of elephant seal males. Data from the current study for southern elephant seal and from Clinton (1994: Table 9.4) for northern elephant seal.

of body size of breeding males is different. Body size is a main component of elephant seal resource holding potential, being related to dominance, fasting, endurance and breeding success (Le Boeuf and Reiter, 1988). Southern elephant seals are not only bigger (McLaren, 1993), but, due to the fact that they carry on growing at late age, should also show a bigger spread in size and RHP, with respect to northern males that almost completely stop growing. This phenomenon may have a deep impact on their social and mating system, because the distribution of RHP among males has a crucial role in determining the effectiveness of mating tactics in such a highly polygynous mating system. Although the two species share the basic aspect of their breeding biology and mating system, they also present many subtle, and less subtle, differences, including higher linearity of dominance hierarchies (Galimberti et al., 2003) and higher inequality in the distribution of breeding success (Fabiani et al., 2004) in the southern species. All these aspects are related to distribution of breeding males RHP and, therefore, may in turn depend on the basic difference in their growth patterns.

II.5.3 Drawbacks of the study

My data set on elephant seal growth presents some drawbacks. The first one, shared with the other data available on southern elephant seal body size and growth, is the biased sampling of different age classes. The first source of this bias is the natural mortality linked to intense male competition (Clinton and Le Boeuf, 1993) that causes few males to survive to late ages. Moreover, by collecting measurements only during the breeding season, I have restricted my sample to breeding males only, increasing the likelihood of a bias. Haulout during breeding season is, itself, related to age-specific breeding strategies,

that can be, themselves, related to growth pattern (Deutsch et al., 1994). Although growth curve analysis is, in general, robust to sampling bias (Leberg et al., 1989), it is rather clear that the estimates of size and growth rate at late age should be considered tentative and representative of a subset of males that survived a strong phenotypic selection process.

A fundamental drawback of cross-sectional data sets is that they cannot account for variability at individual or cohort level. In cross-sectional data sets, the cohort effect cannot be evaluated. In my analysis, although I used longitudinal data, I have refrained from analyzing single cohorts, due to lack of data. Cohort effects depend on variation in population density and/or availability of resources. The SLI population is currently stable (Galimberti et al., 2001) and, therefore, density effects are unlikely.

Other minor drawbacks of my data set and analysis are the error in measurement of age due to the use of estimation based on external morphology, and the bias introduced by using years, instead of a finer time unit, to measure age, but growth analysis seems to be robust with respect to these aspects (Leberg et al., 1989).

II.6 LITERATURE CITED

- Andersson M., 1994. *Sexual selection*. Princeton: Princeton University Press.
- Bell C.M., Hindell M.A., Burton H.R., 1997. Estimation of body mass in the southern elephant seal, *Mirounga leonina*, by photogrammetry and morphometrics. *Marine Mammal Science*. **13**:669-682.
- Burnham K.P., Anderson D.R., 1998. *Model selection and inference: a practical information-theoretic approach*. New York: Springer.
- Calder W.A., 1984. *Size, function, and life history*, 1 ed. Cambridge (MA): Harvard Un. Press.
- Carrick R., Csordas S.E., Ingham S.E., 1962. Studies on the southern elephant seal, *Mirounga leonina* (L.). IV. Breeding and development. *C.S.I.R.O. Wildlife Research*. **7**:161-197.
- Clinton W.L., 1994. Sexual selection and growth in male Northern Elephant Seals. In: *Elephant seals. Population ecology, behavior, and physiology* (Boeuf B.J.L., Laws R.M. eds). Berkeley (CA): University of California Press; 154-168.
- Clinton W.L., Le Boeuf B.J., 1993. Sexual selection's effects on male life history and the pattern of male mortality. *Ecology*. **74**:1884-1892.
- Day T., Taylor P.D., 1997. Von Bertalanffy's growth equation should not be used to model age and size at maturity. *American Naturalist*. **149**:381-393.
- Deutsch C.J., 1990. Behavioral end energetics aspects of reproductive effort of male northern elephant seals (*Mirounga angustirostris*) (Ph.D. Thesis). Santa Cruz (CA): University of California.

- Deutsch C.J., Crocker D.E., Costa D.P., Le Boeuf B.J., 1994. Sex- and age-related variation in reproductive effort of Northern Elephant Seals. In: *Elephant seals. Population ecology, behavior, and physiology* (Laws B.J.L.B.R.M. ed). Berkeley (CA): University of California Press; 169-210.
- Fabiani A., Galimberti F., Sanvito S., Hoelzel A.R., 2004. Extreme polygyny among southern elephant seals at the Falkland Islands: behavioral estimates and genetic paternity. *Behavioral Ecology*. **15**:961-969.
- Fitzhugh H.A., 1975. Analysis of growth curves and strategies for altering their shape. *Journal of Animal Science*. **42**:1036-1051.
- Galimberti F., Boitani L., 1999. Demography and breeding biology of a small, localized population of southern elephant seals (*Mirounga leonina*). *Marine Mammal Science*. **15**:159-178.
- Galimberti F., Fabiani A., Boitani L., 2003. Socio-spatial levels in linearity analysis of dominance hierarchies: a case study on elephant seals. *Journal of Ethology*. **21**:131-136.
- Galimberti F., Sanvito S., Boitani L., Fabiani A., 2001. Viability of the southern elephant seal population of the Falkland Islands. *Animal Conservation*. **4**:81-88.
- Galimberti F., Sanvito S., Braschi C., Boitani L., submitted. The cost of success: reproductive effort in male southern elephant seals. *Behavioral Ecology and Sociobiology*.
- Garlich-Miller J.L., Stewart R.E.A., 1998. Growth and sexual dimorphism of atlantic walruses (*Odobenus rosmarus rosmarus*) in Foxe basin, Northwest territories, Canada. *Marine Mammal Science*. **14**:803-818.

- Haley M.P., 1994. Resource-holding power asymmetries, the prior residence effect, and reproductive payoffs in male northern elephant seal fights. *Behavioral Ecology and Sociobiology*. **34**:427-434.
- Haley M.P., Deutsch C.J., Le Boeuf B.J., 1991. A method for estimating mass of large pinnipeds. *Marine Mammal Science*. **7**:157-164.
- Koops W.J., 1986. Multiphasic growth curve analysis. *Growth*. **50**:169-177.
- Laws R.M., 1953. The elephant seal (*Mirounga leonina* Linn.). I. Growth and age. *Scient. Rep. Falkland Is. Depend. Surv.* **8**:1-62.
- Le Boeuf B.J., 1974. Male-male competition and reproductive success in elephant seals. *American Zoologist*. **14**:163-176.
- Le Boeuf B.J., Laws R.H., 1994. *Elephant seals. Population ecology, behavior and physiology*, 1 ed. Berkeley, CA: University of California Press.
- Le Boeuf B.J., Reiter J., 1988. Lifetime reproductive success in northern elephant seals. In: *Reproductive success. Studies of individual variation in contrasting breeding systems* (Clutton-Brock T.H. ed). Chicago: University of Chicago Press; 344-362.
- Leberg P.L., Brisbin I.L., Smith M.H., White G.C., 1989. Factors affecting the analysis of growth patterns of large mammals. *Journal of Mammalogy*. **70**:275-283.
- Lessells C.M., Boag P.T., 1987. Unrepeatable repeatabilities: a common mistake. *Auk*. **104**:116-121.
- Manly B.F.J., 1997. *Randomization, bootstrap and Monte Carlo methods in biology*. London: Chapman and Hall.
- McCann T.S., 1981. Aggression and sexual activity of male Southern elephant seals, *Mirounga leonina*. *Journal of Zoology London*. **195**:295-310.

- McLaren I.A., 1993. Growth in pinnipeds. *Biological Reviews*. **68**:1-70.
- Norusis M.J., 1994. *SPSS Advanced Statistics 6.1*. Chicago: SPSS Inc.
- Roff D.A., 1992. *The evolution of life histories: theory and analysis*, 1 ed. London:
Chapman and Hall.
- Sanvito S., Galimberti F., 2003. Source level of male vocalizations in the genus
Mirounga: repeatability and correlates. *Bioacoustics*. **14**:45-57.
- Schluter A., Parzefall J., Schlupp I., 1998. Female preference for symmetrical vertical
bars in male sailfin mollies. *Animal Behaviour*. **56**:147-153.
- Schmidt-Nielson K., 1984. *Scaling: why is animal size so important?* Cambridge:
Cambridge University Press.
- Siegel S., Castellan N.J., 1988. *Non parametric statistics for the behavioral sciences*.
New York: McGraw Hill.
- Smith R.J., 1980. Rethinking allometry. *Journal of theoretical Biology*. **87**:97-111.

III - Having a big nose: structure, ontogeny and function of the elephant seal proboscis

(Submitted to *Canadian Journal of Zoology*)

III.1 ABSTRACT

The proboscis of male elephant seals (*Mirounga* spp) has been suggested as an example of a secondary sexual trait since Darwin. There has been much speculation about its function (signal of breeding status, amplification of vocalizations, female choice trait). Notwithstanding this, it has never been studied before, probably due to its fleshy nature that makes measurement difficult. In this paper, I employ a photogrammetric method to measure the proboscis and facial morphology of a large sample of wild, unrestrained southern elephant seals (*Mirounga leonina*). I describe the ontogeny and allometry of the proboscis, and I analyze the current phenotypic selection pressures on proboscis traits. I discuss the potential role of the proboscis in optical and acoustic signaling of male resource holding potential and status. I demonstrate that the proboscis size is positively correlated with both age and size, and that it is currently under a positive sexual selection pressure, even when the effect of selection on whole body size is removed. I suggest that selection on proboscis size is functionally related to the emission of agonistic vocalizations.

III.2 INTRODUCTION

Secondary sexual traits, *i.e.*, traits involved in mate acquisition but not having a direct morphological or physiological function in reproduction, are a striking aspect of organic evolution, and have long been at the core of evolutionary theory (Darwin, 1859; 1871). Elephant seals (*Mirounga*) are an extreme example of sexual dimorphism (Andersson, 1994), with males not only being much larger than females (Le Boeuf and Laws, 1994), but also having a well developed suite of secondary sexual traits. In particular, they bear a proboscis, which is an expansion of the nose that can be erected by muscular action (Laws, 1953). The proboscis has no apparent role in respiration, or in other non-social processes, and has been interpreted as a secondary sexual trait since Darwin: "The nose of the male sea-elephant (*Macrorhinus proboscideus*) becomes greatly elongated during the breeding-season, and can then be erected. In this state it is sometimes a foot in length. The female is not thus provided at any period of life. The male makes a wild, hoarse, gurgling noise, which is audible at a great distance and is believed to be strengthened by the proboscis; the voice of the female being different. Lesson compares the erection of the proboscis, with the swelling of the wattles of male gallinaceous birds whilst courting the females" (Darwin, 1871). The proboscis is present in both species of elephant seals, but differs in shape, and is larger in the northern species, which is smaller in body size (Briggs and Morejohn, 1976; Laws, 1953; Le Boeuf, 1974; Le Boeuf and Laws, 1994).

Sexual differences in facial morphology are widespread in pinnipeds, presumably for signalling purposes (Miller and Boness, 1979). Elephant seals appear to be unique in exhibiting seasonal variation in facial morphology as the proboscis is much larger during

the breeding season, even when relaxed, and may act as a visual signal of breeding status and arousal (McCann, 1981). The proboscis is much expanded when males vocalize, so it may also be involved in the production of aggressive vocalizations (Laws, 1953), although this role has been dismissed by most researchers (McCann, 1981; Sandegren, 1976). As a secondary sexual trait, the proboscis may be under sexual selection in relation to mate choice by females, although this form of sexual selection is probably limited (Cox and Le Boeuf, 1977) or absent (Galimberti et al., 2000) in elephant seals.

Speculations about the proboscis function have been based on anecdotal information and indirect evidences. The proboscis is a fleshy trait, so is intrinsically difficult to measure. Moreover, it should be measured when inflated; hence it is not meaningful to measure it on dead or anesthetized individuals. Ideally, the proboscis should be measured when males are displaying or vocalizing. I present measurements of male proboscis size and facial morphology obtained during a longitudinal study of a small population of southern elephant seals of the Falkland Islands. I used a photogrammetric method to measure the proboscis and facial area of unrestrained animals during the stereotyped display usually shown at the beginning of agonistic contests. This display includes proboscis erection and can be elicited by human approach (Sanvito and Galimberti, 2000). I calculated measurement error and repeatability of traits, analyzed proboscis growth and allometry, and carried out a phenotypic selection analysis by estimating nonparametric fitness functions and calculating sexual selection gradients on proboscis traits.

III.3 METHODS

Data were collected during two breeding seasons (September-November, 1996 and 2002) at Sea Lion Island (Falkland Islands; SLI hereafter), which has a small (~60 breeding males and ~550 breeding females) and localized population of southern elephant seals (Galimberti et al., 2001). All males were individually marked by numbered cattle tags (Jumbo Rototags, Dalton ID Systems Ltd.), some at birth and the remainder during their first haulout at SLI during the breeding season. Tag loss rate, as estimated from double tagging experiments assuming independent loss of each tag, was low (mean probability of losing both tags = 0.25%). Each breeding season, all breeding males were also uniquely marked with hair dye at haulout for rapid identification. Further details on the marking protocol are in Galimberti and Boitani (1999).

III.3.1 Estimation of age

Age was known for males tagged as pups and was estimated (to ± 1 year) for other males, based on external features (Clinton, 1994; Galimberti and Boitani, 1999). I placed males in eight age categories: juvenile (JUV1 to JUV3; 3 to 5 years old, pooled in a single JUV class for the present study); sub-adults (SAM1 to SAM4; 6 to 9 years old) and adults (AD ≥ 10 years old). I checked age-category assignment using three criteria: intra- and inter-observer reliability, and correspondence with known age. Reliability was calculated using the Kendall coefficient of concordance (Siegel and Castellan, 1988), on the age category attributed to marked males in a random sample of 10 daily censuses carried out during the 3-weeks period around the peak of breeding season. Mean intra-observer reliability was

0.95, and inter-observer reliability ranged from 0.93 to 0.99 for two to four observers. Congruence of the whole classification was checked using lifetime records of the males that were present for three or more breeding seasons, and by comparing age category with known age for males tagged at birth. In the analysis involving age, the sample comprised only males for which I had a good age estimate.

III.3.2 Estimation of body length

Body length was estimated using a photogrammetric method (Bell et al., 1997; Haley et al., 1991; Chapter 2). The method requires the animals to lie on a flat surface and with good alignment of body parts. Pictures were taken opportunistically when animals were on sand or after animals moved to a suitable substrate. One person approached the seal from behind, and held a telescopic 4-m long (1 cm increments) surveying pole (Model 406 BIS/D – Salmoiraghi Strumenti Spa, Milano, Italy - <http://www.salmoiraghistrumenti.it>) over its body, aligned with the seal's major axis. A second operator checked the alignment of the pole using the middle of the proboscis as reference, then took photographs of the side of the animal from a distance of 10-20 m, with the camera 50-100 cm above the ground. Measurements from photographs taken at the same time were averaged. Measurements from photographs after an animal substantially changed position or alignment were considered to be independent. I used a Canon EOS1 SLR camera with a 35-70 mm lens and Agfa 100 ASA black-and-white film, or a Canon PowerShot D20 digital camera working at the highest resolution (3.1 megapixels). Black-and-white images were scanned at high resolution as TIFF files, and digital pictures were converted from JPEG to TIFF format (3072 x 2048 pixels). Pictures



Figure III.1 - The photogrammetric method, used for measurement of the proboscis

were measured using Object Image software (by Norbert Vischer, <http://simon.bio.uva.nl/object-image.html>), using the pole in the picture as reference scale. More details on the application of the methods, including measurement error and repeatability of length estimates, are available elsewhere (Chapter 2).

III.3.3 Photogrammetric measurement of the proboscis

I applied a similar photogrammetric method for the measurement of the proboscis. One observer elicited a head-up posture and held a 2-m segment of the same surveying pole described above in front of the animal and aligned with its long axis (Figure III.1). A second operator took photographs from the side at 2-3 m distance. During each display, I took several photographs using a motor drive, and selected pictures with good alignment and maximum expansion of the proboscis. Photographs were taken using a Canon EOS1 SLR camera, fitted with a 35-135 mm or 70-210 mm lens, on black-and-white film. Negatives were scanned at high resolution, saved as greyscale TIFF files, and processed in Photoshop (version 7, Adobe Inc.) to increase contrast and sharpness. Pictures were then measured using Object Image software.

Proboscis measurements are shown in Figure III.2 and defined in Table III.1. Additional variables were calculated from the measured ones. In particular, due to correlations among proboscis traits (see Results), I ran principal component analysis (PCA) both on whole proboscis traits (trunk_L; bump1_L; bump2_L; bump1_H; bump2_H; bump1_O; bump2_O), and on traits of the two bumps separately (respectively bump1_L, bump1_H and bump1_O; bump2_L, bump2_H and bump2_O). From these analyses, I retained the first principal components as new variables (see Results).

Table III.1 - Definition of morphological variables considered in this study (all units in cm, except for proportions and PC scores)

Variable name	Acronym	Definition	Fig. 1 reference
Measured variables			
Canine length	canine_L	total length of lower canine	EF
Trunk length	trunk_L	maximal length of trunk	ab
Mouth length	mouth_L	maximal opening of mouth, from where it joins trunk to base of lower canine	DE
Trunk fall	trunk_fall	extent to which trunk falls over mouth, covering its opening	Dg
Free mouth	free_mouth	extent of opening of mouth not covered by trunk	gE
1 st bump length	bump1_L	total width of 1 st bump of trunk, measured as linear length of its base	Linear AB
2 nd bump length	bump2_L	total width of 2 nd bump of trunk, measured as linear length of its base	Linear BD
1 st bump outline	bump1_O	total curvilinear length of 1 st bump of trunk	Curvilinear AB
2 nd bump outline	bump2_O	total curvilinear length of 2 nd bump of trunk	Curvilinear BC
1 st bump height	bump1_H	maximal height of 1 st bump of trunk, perpendicular to AB	cd
2 nd bump height	bump2_H	maximal height of 2 nd bump of trunk, perpendicular to BD	ef
Calculated variables			
Trunk size	trunk_size	sum of curvilinear lengths of two bumps (= AB+BC)	
Proportion 1 st bump	p_bump1	1 st bump as proportion of total trunk (= bump1_O/trunk_size)	
Inflation 1 st bump	inflation1	measurement of 1 st bump expansion (= bump1_O/bump1_L)	
Inflation 2 nd bump	inflation2	measurement of 2 nd bump expansion (= bump2_O/bump2_L)	
Trunk inflation	inflation	measurement of total expansion of the trunk (= (Inflation1 * P_bump1)+(Inflation2* P_bump2))	
1 st bump size	size_bump_1	score of first principal component of first bump traits	
2 nd bump size	size_bump_2	score of first principal component of second bump traits	
Trunk 1 st PC	trunk_PC1	score of first principal component of whole trunk traits	
Trunk 2 nd PC	trunk_PC2	score of second principal component of whole trunk traits	

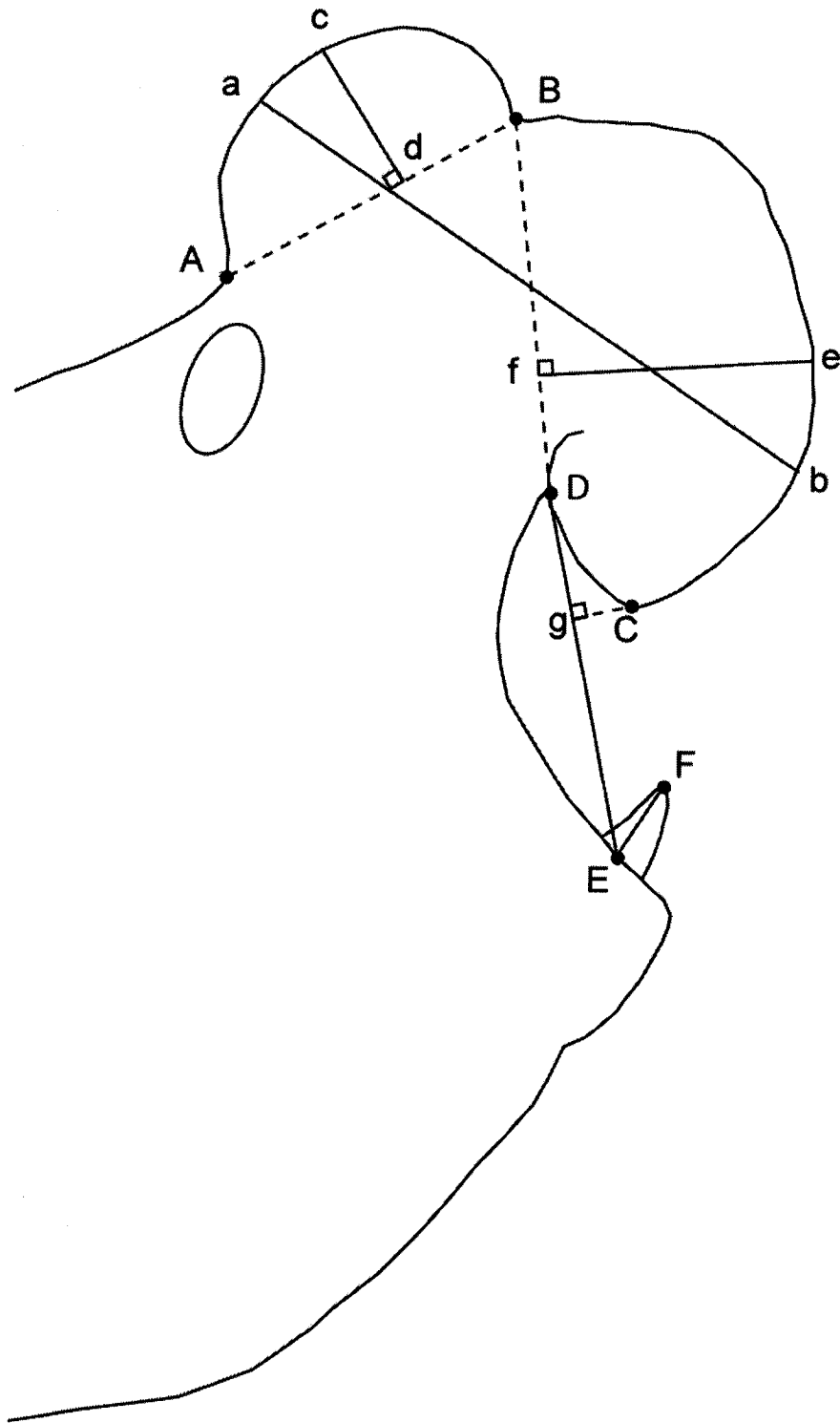

Figure III.2 - Diagram of the measured traits, see Table III.1 for definitions

Principal components were extracted from the covariance matrix of traits, with a Varimax rotation and scores calculated by linear regression.

III.3.4 Measurement error and repeatability

I calculated measurement error using variance components estimated from a model II ANOVA (Bailey and Byrnes, 1990). Percentage measurement error was calculated as the percentage of the within pictures/measurements variance on the total variance (= within pictures/measurements variance + among pictures/measurements variance). Each picture of a set of 20 was measured three times, in random order, and these measurements were used as replicates for the calculation of percentage error. For each trait I calculated the repeatability (R = intraclass correlation coefficient), which is the proportion of the among-individuals variance on total variance (= among individuals variance + within individuals variance). I estimated R using variance components from a Model II ANOVA (Lessells and Boag, 1987). Numbers of measurements per male were not balanced. Therefore, I calculated confidence limits of repeatability using a jackknife delete-one procedure (Manly, 1991), and tested its difference from zero using randomization (10000 resamplings). Only males with three or more independent measures were included in the repeatability analysis (Bailey and Byrnes, 1990).

III.3.5 Modelling proboscis growth

To study proboscis growth I fitted three models: an exponential model, a simple linear regression and a piecewise linear regression. Exponential curves derived from the

Richards generalized curve are a standard method to fit growth data (Fitzhugh, 1975). I fitted the following logistic curve:

$$Trait = \frac{A}{1 + be^{-kAge}}$$

The main parameters are A, which is the asymptotic length, and k, which determines the reduction in growth rate as age increases (b is a scaling factor not relevant here).

Recently there has been a growing interest in multiphasic growth models (Clinton, 1994; Koops, 1986). A visual inspection of scatterplots of proboscis traits versus age with a fitted LOWESS smoother (Trexler and Travis, 1993) showed a clear bending point in some cases. Therefore, I fitted the following piecewise model with unknown bending point (Muggeo, 2003):

$$Trait = a_0 + (b_1 * Age) + (b_d * (Age - BP) * (Age > BP))$$

where BP is the bending point; a_0 is the intercept of the regression line before the bending point; b_1 is the slope of the regression line before the bending point; b_d is the difference in the slope between the regression line before and after the bending point; and $Age > BP$ is a logic condition, returning 0 for ages $\leq BP$, and 1 for ages $> BP$. Therefore, the slope of the regression line after the bending point (b_2) is equal to $b_d + b_1$. I tested the difference between steepness before and after the bending point by testing the null hypothesis $H_0: b_d = 0$ (for which b_1 and b_2 are the same). The logistic and the piecewise models were fitted by SYSTAT software (version 11, Systat Inc.) using a least squares loss function and the Levenberg-Marquardt algorithm. Asymptotic standard errors (se) were checked using bootstrap; due to the similarity between asymptotic and bootstrapped errors I present only the former. Models were compared using the corrected Akaike information criterion

(AIC); a difference in AIC equal or greater than 2 gives moderate evidence that the model with the lower AIC should be preferred, and a difference ≥ 7 gives strong evidence (Burnham and Anderson, 1998).

III.3.6 Allometry

I carried out univariate allometric analysis of facial traits (proboscis, mouth, and canines) using log-transformed data. There is no universal agreement on the best protocol for allometric analysis (La Barbera, 1989), in particular in relation to the best regression model to be used (McArdle, 1988). Out of the three most widely used univariate linear models, (major axis, MA); standard major axis, SMA; ordinary least squares, OLS), I used SMA. I chose this model because variables were log-transformed, body size and facial traits were measured in the same unit (cm), and both body size and facial traits were measured using the same photogrammetric method and so should have approximately similar error variances. Of the three methods, OLS regression is the least suitable, because it is unlikely that the body size error variance is so low as to be considered null with respect to the facial traits error variances. MA is always less effective than SMA (McArdle, 1988). The application of SMA for the estimation of allometric coefficients requires the presence of a significant correlation between trait size and body size (Legendre and Legendre, 1998); therefore, as a preliminary to allometric analysis, I calculated Pearson's r and tested its difference from 0 by permutation. I calculated standard errors and confidence intervals for the allometric parameter using a jackknife delete-one procedure (Manly, 1991).

I analyzed multivariate allometry of the proboscis using the methods of Jolicoeur (1963), carrying out a PCA of the covariance matrix of log-transformed traits of the proboscis, then a SMA regression of the first principal component on log-transformed body size. The confidence interval of the multivariate allometric coefficient was again calculated with the jackknife delete-one procedure.

III.3.7 Phenotypic selection

I carried out phenotypic selection analysis following Arnold and Wade (1984a and 1984b) and Conner (1996). I calculated three measures of individual fitness: female days (= the sum of the number of females held by a male over each day of presence on land; FF/DAYS (Clutton-Brock et al., 1979; Clutton-Brock et al., 1982); mating success (= number of copulations with intromission ≥ 60 sec observed per 100 hours of observation; MS₁₀₀, Campagna and Le Boeuf 1988); and estimated number of females inseminated (= the proportion of observed copulations achieved by a male in a harem multiplied by the total number of females that bred in that harem, summed over all harems in which the male was observed to copulate; ENFI, Le Boeuf 1974). The three measures were strongly correlated (Pearson's r , with randomization test: FF/DAYS vs MS₁₀₀, 0.869, $P_{10k} = 0.0001$; FF/DAYS vs ENFI, 0.972, $P_{10k} = 0.0001$; MS₁₀₀ vs ENFI, 0.919, $P_{10k} = 0.0001$). Therefore, I chose ENFI as a fitness measure for the following analysis, because it is the best index of the actual number of genetic paternities (Fabiani et al., 2004). Absolute fitness was transformed to relative fitness by dividing by yearly mean fitness. As a preliminary step to selection analysis, I calculated the opportunity for selection (I), which represents an upper limit to phenotypic selection (Arnold and Wade, 1984a). To test

whether the observed I was greater than expected from random access to females (Sutherland, 1987), I used a parametric method, comparing the observed distribution of ENFI to a Poisson distribution with mean equal to the observed mean ENFI (Banks and Thompson, 1985), and a non parametric method based on Monte Carlo simulation (McLain, 1986). For each cycle of the simulation, each female was fertilized by one male chosen at random, and the resulting I was calculated. After 10000 cycles I calculated the proportion of cycles in which the simulated I was greater than the observed I . I fitted non-parametric fitness functions for each morphological trait using cubic splines with the smoothing parameter chosen by cross-validation (Schluter, 1988). I then calculated 95% confidence bands for the fitness functions using a bootstrap procedure (10000 samples). I estimated univariate selection pressures on each trait by calculating selection differentials (s = the covariance between relative fitness and the trait) and selection intensities (i = the selection differential for the standardized trait). Selection differentials measure direct effects of selection on a trait plus indirect effects due to selection on other traits correlated with the first (Arnold and Wade, 1984a). Therefore, I calculated selection gradients (β), which measure the selection pressures directly acting on a trait. I calculated selection gradients with a multiple regression of relative fitness on standardized traits. The fitness measure, ENFI, had a skewed distribution with a very long right tail ($g_1 = 2.90$, $g_2 = 9.67$), and over-dispersion ($CV = 2.09$). Therefore, I calculated the standard error and confidence limits of selection differentials and gradients using a jackknife delete-one procedure (Mitchell-Olds and Shaw, 1987), and tested their difference from 0 with randomization (10000 re-samplings; Manly 1991). A problem with multivariate analysis of selection is the correlation among phenotypic traits (= multicollinearity), because it

may produce poor estimates of selection gradients (Mitchell-Olds and Shaw 1987). For each phenotypic trait and each regression model I calculated a collinearity diagnostic, the variance inflation factor, $VIF = 1/(1-R^2_j)$, where R^2_j is the coefficient of determination of the linear regression of a trait j versus all other traits included in the regression model. Values of $VIF > 10$ indicate a serious multicollinearity problem (Rawlings, 1988).

III.3.8 Statistics

I present descriptive statistics as mean \pm standard deviation, and least-squares estimates as estimates \pm standard error. I visually inspected distribution of variables using boxplots and tested normality using the Shapiro-Wilk test (Shapiro 1968). I tested homogeneity of means between the two years of study using t-tests with randomization, and homogeneity of variances using the Brown-Forsythe test, again with randomization (Manly, 1991). In case of multiple tests, I calculated adjusted probabilities using a sequential Bonferroni procedure (Hochberg and Benjamini, 1990). All statistical analyses were carried out using STATA software (version 9, Stata Corporation). The number of resamplings in randomization tests is stated as the subscript of “P” labels; observed values of statistic were included in the resampled statistics (Manly, 1991).

Table III.2 - Descriptive statistics of morphological traits (measured in cm). SD = standard deviation; %ME: percentage measurement error; R: repeatability with 95% confidence interval (95% CI); Normality: Shapiro-Wilk test (W above, P below); Homogeneity of means between 1996 and 2002: t above, P below; Homogeneity of variances between 1996 and 2002: F above, P below

Trait	Mean ± SD (Range)	CV (%)	%ME	R (95% CI)	Normality	Homogeneity of means	Homogeneity of variances
trunk_L	37.6 ± 4.63 (27.8;46.8)	0.12	0.13	0.891 (0.849;0.934)	0.976 0.0895	-1.77 0.0805	0.0005 0.9825
bump1_L	18.0 ± 4.02 (8.5;30.0)	0.22	3.00	0.833 (0.772;0.895)	0.993 0.9194	-1.43 0.1557	0.2912 0.5908
bump1_H	7.88 ± 2.492 (3.35;13.09)	0.32	4.46	0.908 (0.872;0.945)	0.975 0.0737	-0.64 0.5269	0.0257 0.8730
bump1_O	27.0 ± 7.15 (14.2;42.3)	0.27	4.33	0.900 (0.860;0.939)	0.977 0.1032	-0.88 0.3814	0.0479 0.8272
p_bump1	0.41 ± 0.054 (0.28;0.52)	0.14		0.794 (0.721;0.867)	0.982 0.2222	0.18 0.8539	0.1560 0.6938
bump2_L	20.7 ± 3.03 (12.9;28.3)	0.15	9.56	0.765 (0.683;0.846)	0.980 0.1578	-3.23 0.0017	0.2247 0.6366
bump2_H	12.4 ± 2.42 (7.4;17.7)	0.20	0.33	0.835 (0.775;0.897)	0.979 0.1317	-2.66 0.0094	0.0113 0.9156
bump2_O	38.3 ± 8.21 (18.8;54.3)	0.21	2.16	0.800 (0.729;0.872)	0.986 0.4559	-1.34 0.1822	0.1337 0.7155
trunk_size	65.3 ± 13.55 (36.5;94.4)	0.21		0.87964 (0.833;0.926)	0.985 0.3601	-1.28 0.2039	0.0613 0.8050
inflation1	1.51 ± 0.238 (1.11;2.17)	0.16		0.835 (0.773;0.896)	0.969 0.0254	0.77 0.4432	0.8819 0.3502
inflation2	1.85 ± 0.278 (1.29;2.61)	0.15		0.699 (0.602;0.796)	0.981 0.2249	0.99 0.3254	1.5779 0.2123
inflation	1.71 ± 0.242 (1.23;2.32)	0.14		0.757 (0.673;0.841)	0.989 0.6534	0.91 0.3663	1.3830 0.2427
trunk_fall	4.97 ± 2.713 (0.12;10.61)	0.55	0.77	0.746 (0.660;0.833)	0.972 0.0471	-1.66 0.0998	1.0050 0.3188
mouth_L	29.5 ± 3.99 (18.1;42.8)	0.14	0.57	0.710 (0.615;0.805)	0.980 0.1699	0.42 0.6725	0.2971 0.5871
free_mouth	24.6 ± 4.90 (12.3;37.4)	0.20		0.746 (0.660;0.833)	0.991 0.7912	1.26 0.2093	0.3203 0.5729
canine_L	2.5 ± 0.73 (0.9;4.3)	0.30	3.87	0.650 (0.542;0.757)	0.982 0.2276	-0.05 0.9564	0.0205 0.8865

III.4 RESULTS

III.4.1 Measurement error, repeatability and statistics (Table III.2)

Measurement error was < 10% for all traits, and was > 5% just for bump2_L. Measurement error for the outlines, which can be difficult to trace, was not greater than that for linear measures. Repeatability of traits was high and significantly different from 0 for all traits. Size of trunk and of the first bump in particular, had the highest repeatability, while measures of mouth and canine size had the lowest.

In the overall sample, mean trunk length was 37.6 cm, mean trunk size was 65.3 cm and mean mouth opening was 29.5 cm. The distributions of morphological traits were close to normal (Figure III.3, Table III.2). Only bump2_L and bump2_H differed significantly between years (respectively, on average, 1.95 and 1.3 cm longer in 2002), whereas all other traits were homogeneous (Table III.2). Variances of all morphological traits were homogeneous among the two years of study (Table III.2).

III.4.2 Correlations among proboscis traits

Correlations among proboscis traits were positive in all cases, rather high in some cases, and always significantly different from 0 (Table III.3) but, as a whole, they were lower than expected from a set of morphologically integrated traits, with some correlation between 0.3 and 0.4 (mean $r = 0.651$). Relatively low correlations were found between the two bumps, indicating that their development is in part independent. Correlation matrices were homogeneous between years (standardized Mantel statistics = 0.9083, $P_{10k} = 0.9999$). The Bartlett test of sphericity was significant for both years (1996: $\chi^2 = 556.4$,

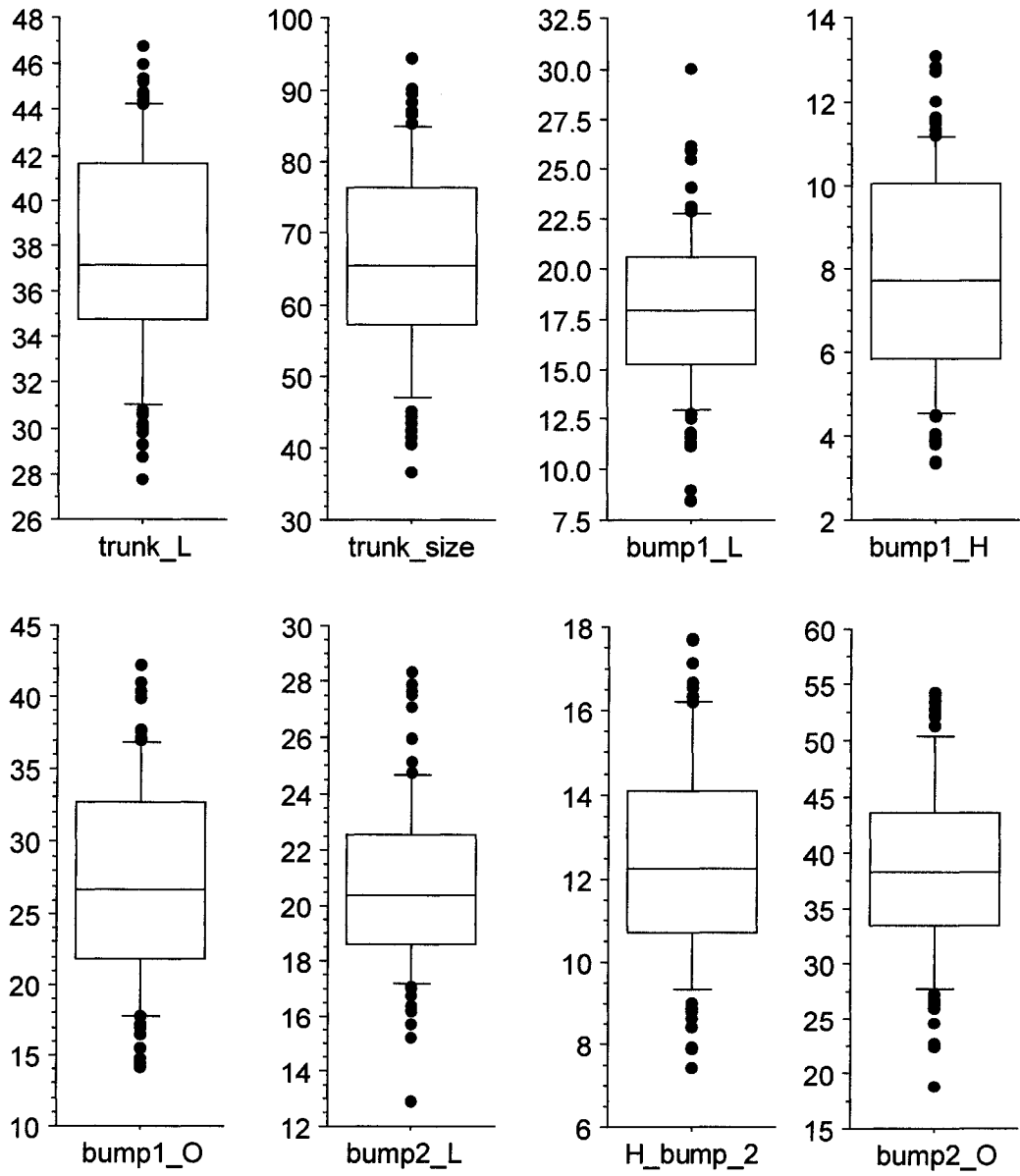

Figure III.3 - Boxplots of the distribution of the main proboscis traits (all measurements are in cm)

Table III.3 - Covariance and correlation matrix for proboscis traits. Covariances above the diagonal, variances on the diagonal, and correlations (Pearson's r) below. * = significant at $\alpha = 0.05$, ** = significant at $\alpha = 0.01$ (sequential Bonferroni correction, see Methods)

	trunk_L	bump1_L	bump1_H	bump1_O	bump2_L	bump2_H	bump2_O
trunk_L	21.4	12.0	9.5	27.3	10.2	9.5	30.2
bump1_L	0.643**	16.2	7.0	23.8	3.79	3.54	9.49
bump1_H	0.824**	0.697**	6.21	17.3	3.11	3.94	12.7
bump1_O	0.824**	0.828**	0.969**	51.1	8.29	10.5	32.6
bump2_L	0.725**	0.311*	0.411**	0.383**	9.19	5.64	18.5
bump2_H	0.846**	0.363**	0.652**	0.608**	0.767**	5.88	18.7
bump2_O	0.794**	0.288*	0.619**	0.556**	0.742**	0.939**	67.4

df = 27, $P < 0.0001$; 2002: $\chi^2 = 484.0$, df = 27, $P < 0.0001$). I ran a PCA on the covariance matrix of the proboscis traits. The first two components explained more than 93% of the variance of the seven original variables. The two traits with the higher loadings were the two outlines. Scores on the first two PCs were used as summary measures of proboscis size and shape (trunk_PC1 and trunk_PC2) for subsequent analyses.

Traits measured for each bump showed the highest correlations, so I ran a PCA to calculate a summary measure of each bump size. For the first bump, the first principal component explained about 93% of the variance of the original 3 traits, and its scores were retained as a new variable, size_bump_1. For the second bump, the first principal component explained about 95% of the variance, and its scores were retained as a new variable size_bump_2.

III.4.3 Age-related variation in facial morphology

Almost all proboscis traits, except the free_mouth and the p_bump1, showed an almost linear increase in the mean with the increase of age class (Table III.4). There was also a change in shape, with an increase in the inflation of both bumps as well as of the whole proboscis (Figure III.4).

The iterative Levenberg-Marquardt algorithm with least squares loss function used to fit the logistic model achieved convergence for only 9 traits out of 17, showing that the logistic model, and asymptotic exponential models at large, are not adequate descriptions of proboscis growth. Although there was an apparent reduction in the slope of the age specific variation of some proboscis traits around age 9, no trait showed the presence of a clear asymptote, little variance was explained by the logistic model for most traits

Table III.4 - Change of morphological traits with age. Means (cm) for each age class (expressed in years) are shown. Sample size in parentheses below the age class in the first row of the table

Trait	5 (1)	6 (5)	7 (21)	8 (19)	9 (13)	10 (9)	11 (10)	12 (3)	13 (1)	14 (1)
trunk_L	30.7	32.3	35.1	37.4	40.9	40.2	40.5	44.3	41.7	44.3
bump1_L	12.5	17.1	17.1	17.1	19.9	16.7	19.5	25.0	16.6	23.0
bump1_H	3.92	4.91	7.01	7.18	9.66	9.04	9.76	11.7	7.68	11.3
bump1_O	15.6	20.6	24.4	24.9	32.0	29.2	32.0	39.0	26.6	37.6
p_bump1	0.405	0.429	0.407	0.384	0.427	0.394	0.439	0.472	0.451	0.416
bump2_L	15.7	18.3	19.8	21.2	22.6	21.8	21.3	21.5	20.1	21.1
bump2_H	8.6	9.6	11.6	12.7	14.0	13.9	13.4	14.3	10.7	14.8
bump2_O	22.9	28.0	35.0	39.8	43.0	44.5	41.5	43.6	32.3	52.6
trunk_size	38.4	48.6	59.4	64.6	75.0	73.7	73.6	82.6	58.9	90.2
inflation1	1.24	1.22	1.44	1.47	1.60	1.78	1.66	1.58	1.60	1.66
inflation2	1.46	1.53	1.76	1.90	1.92	2.05	1.95	2.04	1.61	2.49
inflation	1.37	1.40	1.63	1.73	1.79	1.95	1.84	1.82	1.60	2.14
trunk_fall	1.27	2.71	3.95	4.92	6.93	6.21	6.05	8.26	2.17	10.2
mouth_L	28.2	26.8	28.8	28.4	29.1	30.6	32.7	28.8	36.2	38.8
free_mouth	26.9	24.1	24.8	23.5	22.2	24.4	26.6	20.5	34.1	28.7
canine_L	2.28	1.70	2.32	2.35	2.55	2.88	2.41	2.60	3.28	3.89

JUV3



SAM1



SAM2



SAM3



SAM4



AD



Figure III.4- Elephant seal facial development with age. The pictures show different individuals belonging to different age classes, from juvenile to fully developed adults. For age categories definition see page 62

(mean $R^2 = 0.327$), and the standard error of the b parameter was often very large. Estimated parameters had large correlations in most cases, in particular b and k , a clear sign of over-parameterization. Therefore, I concentrated on linear models. The visual examination of scatterplots with LOWESS smoothers suggested that some traits increased almost linearly until approximately age 9, and then either stopped growing, or had much reduced growth rate. Therefore, I fitted first a linear regression, and I then compared the fit of this model with the fit of a piecewise regression with unknown bending point, using the corrected AIC (Table III.5). For some traits, a better fit was obtained with the piecewise model. In particular, trunk length, the second bump and the inflation of the proboscis showed a clear turning point at age 9, whereas growth was linear for the first bump (Table III.6; Figure III.5).

III.4.4 Allometry of the facial morphology

Almost all proboscis traits increased with body length (Figure III.6). SMA analysis showed high positive allometry on most traits of facial morphology (Table III.7), and the 95% confidence limits did not include the isometric slope for all cases except the three inflation measures. Traits of the first bump had steeper allometric coefficients than traits of the second bump. I analyzed the multivariate allometry of the proboscis using the methods of Jolicoeur (1963; see Methods). The resulting multivariate allometric coefficient was significantly larger than 1 (Table III.7), confirming the positive allometry observed in the univariate analysis. I tested the significance of the multivariate allometry coefficient, calculated by SMA, with the correlation coefficient (see Methods) finding that it was not significant at $\alpha = 0.05$.

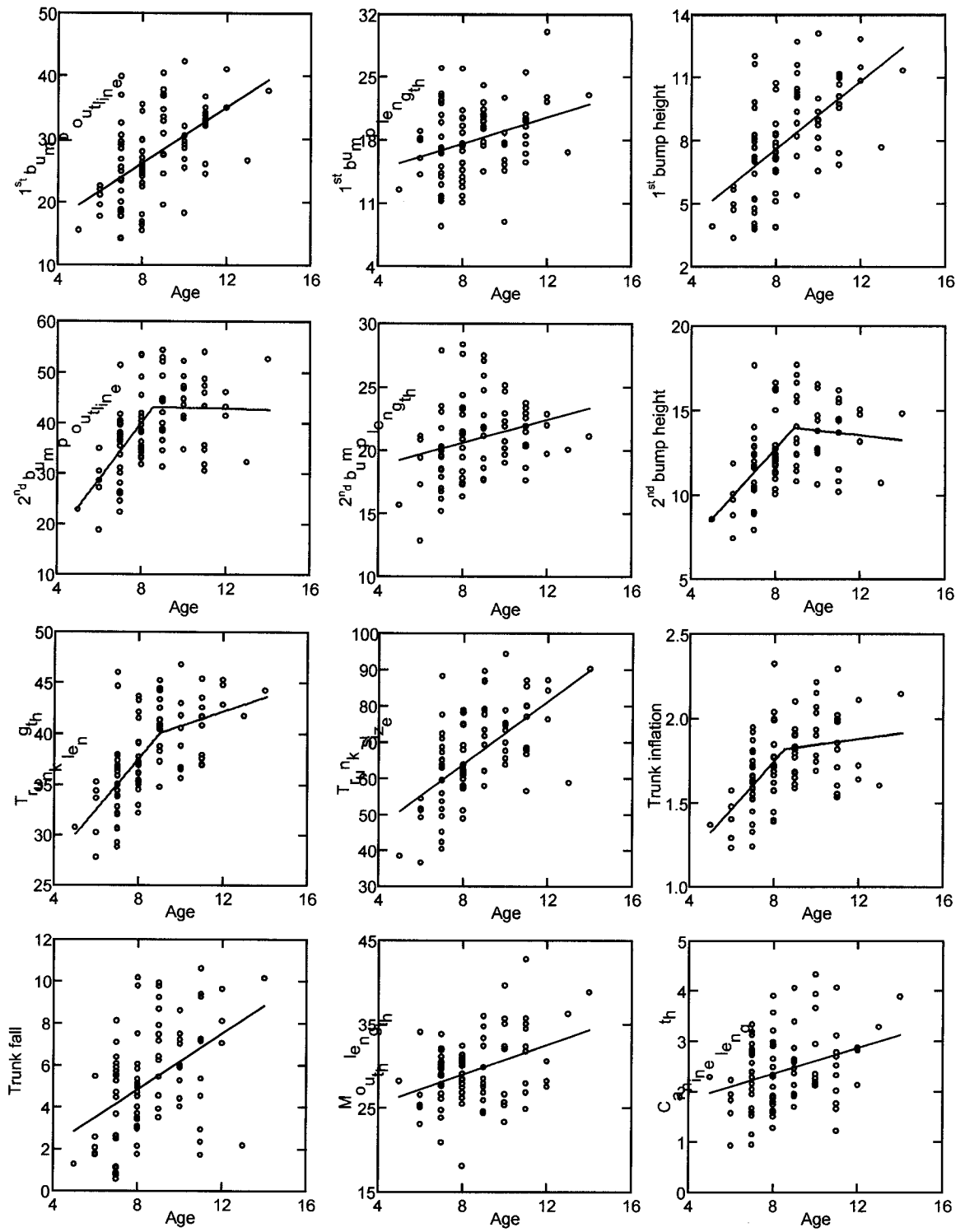

Figure III.5 - Scatterplots of some facial traits over age, with fitted linear regressions or piecewise regressions (see Methods). Age measured in years and proboscis traits in cm.

Table III.5 - Comparison of simple linear regression (two-parameters model) and piecewise regression (four-parameters model) for facial traits using AIC (see Methods). Differences in AIC between models for the traits fitted better by the piecewise regression (difference ≥ 2) are shown in bold.

Trait	(A) AIC of piecewise regression	(B) AIC of linear regression	(A) – (B)
trunk_L	214.4	216.4	-2.0
bump1_L	230.5	226	4.5
bump1_H	159.3	119	40.3
bump1_O	304.6	300.1	4.5
p_bump1	-476.5	-479.3	2.8
bump2_L	195.1	184.5	10.6
bump2_H	124.3	131.2	-6.9
bump2_O	322.7	330.9	-8.2
trunk_size	405.2	400.8	4.4
inflation1	-260.3	-255.8	-4.5
inflation2	-226.4	-225.8	-0.6
inflation	-258.2	-255.7	-2.5
trunk_fall	149.3	147.6	1.7
mouth_L	232.2	229.1	3.1
free_mouth	271.8	270.7	1.1
canine_L	-39.9	-52.7	12.8

Table III.6 - Linear regression and piecewise regression models of growth of facial morphology. R^2 = coefficient of determination; SE = standard error; 95% CI = 95% confidence interval; P = for linear regressions significance of the regression coefficient ($H_0: b=0$), for piecewise regressions significance of the change in slope after the bending point BP ($H_0: b_d = 0$). N = 83 males for all traits and models.

Linear regression								
Trait	R^2	b ± SE (95% CI)	P					
bump1_L	0.107	0.73 ± 0.23 (0.264;1.186)	0.0025					
bump1_H	0.350	0.81 ± 0.12 (0.571;1.041)	0.0000					
bump1_O	0.311	2.19 ± 0.33 (1.530;2.856)	0.0000					
bump2_L	0.072	0.45 ± 0.16 (0.138;0.766)	0.0145					
trunk_size	0.341	4.31 ± 0.72 (2.891;5.738)	0.0000					
inflation_2	0.187	0.07 ± 0.02 (0.031;0.101)	0.0000					
trunk_fall	0.207	0.67 ± 0.16 (0.344;0.988)	0.0000					
mouth_L	0.147	0.88 ± 0.25 (0.388;1.381)	0.0003					
free_mouth	0.006	0.22 ± 0.33 (-0.444;0.880)	0.5140					
Canine_L	0.096	0.13 ± 0.04 (0.044;0.211)	0.0050					
Piecewise regression								
Trait	R^2	BP	a_0 (95% CI)	b_1 (95% CI)	b_d (95% CI)	b_2	t	P
trunk_L	0.433	9	17.5 (10.3;24.7)	2.51 (1.57;3.44)	-1.80 (-3.48;-0.13)	0.71	-2.139	0.0354
bump2_H	0.290	9	1.64 (-4.28;7.56)	1.39 (0.58;2.20)	-1.53 (-2.51;-0.56)	-0.14	-3.145	0.0023
bump2_O	0.335	9	-4.59 (-24.1;15.0)	5.58 (2.91;8.26)	-5.67 (-8.88;-2.46)	-0.09	-3.518	0.0007
inflation1	0.307	10	0.674 (0.260;1.087)	0.10 (0.05;0.16)	-0.14 (-0.23;-0.04)	-0.03	-2.829	0.0059
inflation	0.297	9	0.613 (0.022;1.203)	0.14 (0.06;0.22)	-0.13 (-0.22;-0.03)	0.02	-2.575	0.0118

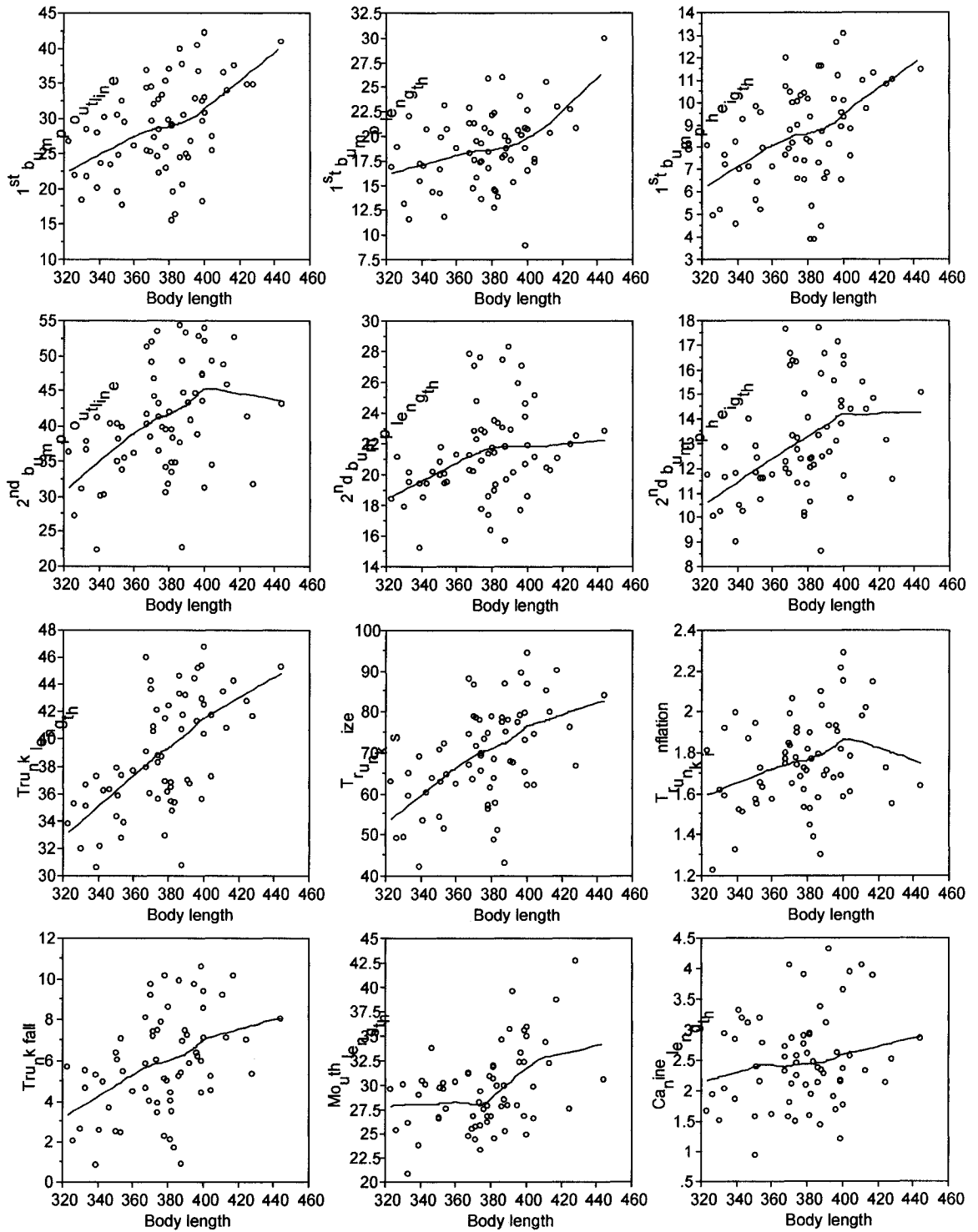

Figure III.6 - Scatterplots of some facial traits over body length, with fitted LOWESS smoother. All measurements are in cm.

Table III.7 - Allometry of facial morphology. Univariate allometric coefficients calculated by standard major axis, and multivariate allometric coefficient calculated following Jolicoeur (1963); standard errors and confidence limits calculated using a jackknife delete-one procedure. b = allometric coefficient; SE = standard error; 95% CI = 95% confidence interval; r = Pearson correlation coefficient r above, and probability of the randomization test on the null hypothesis H0: r = 0 below. N = 67 males for all traits.

Trait	b ± SE (95% CI)	r
trunk_L	1.429 ± 0.147 (1.170;1.745)	0.582 0.0001
bump1_L	3.018 ± 0.363 (2.391;3.809)	0.311 0.0106
bump1_H	3.884 ± 0.427 (3.105;4.860)	0.408 0.0008
bump1_O	3.442 ± 0.370 (2.749;4.308)	0.402 0.0011
bump2_L	1.793 ± 0.240 (1.417;2.269)	0.280 0.0225
bump2_H	2.251 ± 0.246 (1.783;2.842)	0.310 0.0112
bump2_O	2.870 ± 0.331 (2.274;3.623)	0.311 0.0105
trunk_size	2.568 ± 0.286 (2.057;3.205)	0.427 0.0005
inflation1	1.176 ± 0.141 (0.925;1.495)	0.195 0.1160
inflation2	1.230 ± 0.134 (0.967;1.565)	0.179 0.1478
inflation	1.087 ± 0.129 (0.856;1.381)	0.210 0.0864
trunk_fall	9.171 ± 0.716 (7.239;11.618)	0.261 0.0197
mouth_L	1.840 ± 0.206 (1.478;2.291)	0.452 0.0002
free_Mouth	2.879 ± 0.296 (2.266;3.657)	0.215 0.0416
canine_L	3.241 ± 0.356 (2.550;4.120)	0.235 0.0588
Multivariate allometry	15.184 ± 2.016 (11.942;19.306)	0.197 0.1167

III.4.5 Phenotypic selection

Mean ENFI was 11.7 females and opportunity for selection was 4.18 ($N = 92$ males). ENFI values showed a greater dispersion than that for a Poisson distribution with the same mean, with a very long positive tail (Kolmogorov-Smirnov test with permutation: KS statistics = 0.6836, $p_{10k} = 0.0001$). Observed I also was significantly greater than I expected with random allocation of female fertilizations to males ($P_{10k} = 0.0001$). Nonparametric fitness functions for some of the traits are shown in Figure III.7. A common feature of the fitness functions was a slope close to zero in the first part of the range, where males had fitness close to zero, then a steep increase in the second part. Selection differentials and selection intensities are summarized in Table III.8. Various traits, including all measures of size of the trunk, had positive and statistically significant selection differentials. In contrast, selection differentials on mouth traits and canine length were not significant.

Only trunk length had a statistically significant positive gradient (Table III.9A), but the data set showed clear signs of multicollinearity (mean VIF = 22.9). Therefore, I ran another analysis using trunk length and the two outlines as measures of bumps (Table III.9B). In this second analysis, there was a statistically significant positive selection gradient on trunk length only, while the other two gradients, positive on the size of the first bump and negative on the size of the second, were not significant. Although these three traits were highly correlated, multicollinearity was much lower than in the full traits set (mean VIF = 4.2). Individual fitness in elephant seals is strongly related to body size, which is also related to the trunk size. Therefore, I calculated selection gradients for a two traits model including body length and trunk length. Although the main effect was due to

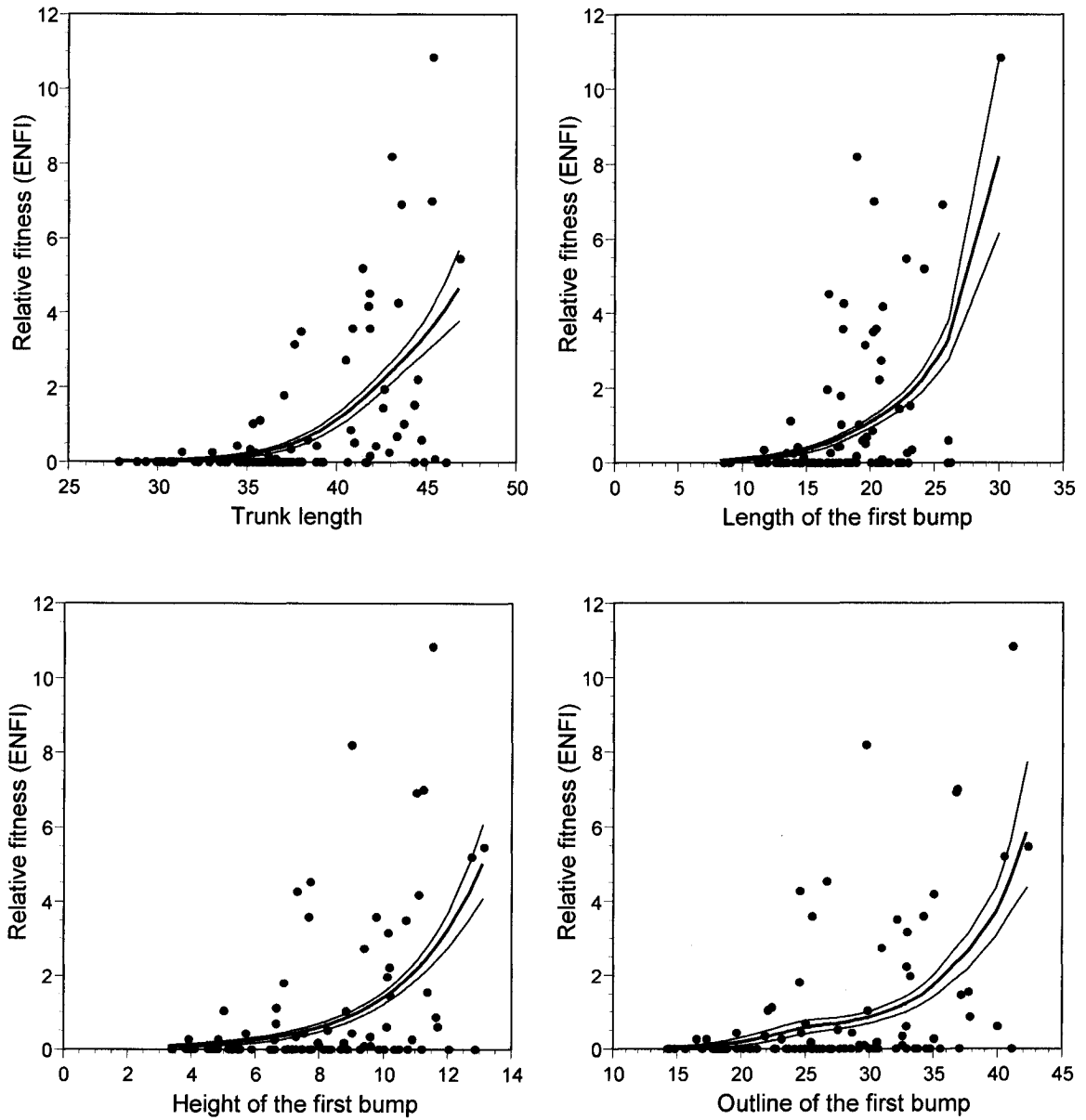

Figure III.7 - Non parametric univariate fitness functions of some proboscis traits (see Methods)

Table III.8 - Selection differentials and selection intensities on facial traits. Standard errors and confidence limits calculated using a jackknife delete-one procedure. s = selection differential; i = selection intensity; $SE(s)$ = standard error of the differential; CI = 95% confidence interval of selection differentials; P_{10k} = probability of the randomization test on the null hypothesis $H_0: s = 0$ (selection differentials statistically significant from 0 at $\alpha = 0.05$ in bold)

Trait	$s \pm SE$ (95% CI)	i	P_{10k}
trunk_L	4.847 \pm 1.253 (2.358;7.337)	1.047	0.0001
bump1_L	3.35 \pm 1.464 (0.442;6.259)	0.841	0.0001
bump1_H	2.076 \pm 0.613 (0.859;3.293)	0.827	0.0001
bump1_O	6.346 \pm 2.030 (2.315;10.378)	0.888	0.0001
p_bump1	0.018 \pm 0.012 (-0.007;0.042)	0.280	0.0960
bump2_L	2.161 \pm 0.782 (0.609;3.714)	0.556	0.0025
bump2_H	0.399 \pm 1.000 (-1.588;2.386)	0.046	0.3120
bump2_O	6.324 \pm 1.940 (2.470;10.177)	0.648	0.0003
p_bump2	-0.051 \pm 0.022 (-0.095;-0.007)	-0.317	0.9934
trunk_size	14.012 \pm 3.892 (6.281;21.742)	0.795	0.0001
inflation1	0.066 \pm 0.041 (-0.016;0.149)	0.274	0.1002
inflation2	0.122 \pm 0.059 (0.005;0.239)	0.425	0.0296
inflation	-0.687 \pm 0.463 (-1.606;0.232)	-0.164	0.7582
trunk_fall	1.577 \pm 0.580 (0.426;2.728)	0.581	0.0031
mouth_L	3.287 \pm 0.930 (1.440;5.134)	0.823	0.0001
free_mouth	2.531 \pm 1.130 (0.286;4.776)	0.385	0.0250
canine_L	-4.007 \pm 2.570 (-9.112;1.098)	-0.171	0.7784

Table III.9 - Selection gradients on proboscis traits. A) seven traits of the proboscis, B) reduced set of traits (see Results). Standard errors and confidence limits calculated using a jackknife delete-one procedure. β = selection gradient; SE = standard error, 95% CI = confidence interval; P_{10k} = probability of the randomization test on the null hypothesis $H_0: \beta = 0$ (selection gradients statistically significant from 0 at $\alpha = 0.05$ in bold)

A)

Trait	$\beta \pm SE$ (95% CI)	P_{10k}
trunk_L	1.484 \pm 0.661 (0.232;2.859)	0.0321
bump1_L	0.556 \pm 0.897 (-1.197;2.367)	0.3886
bump1_H	0.483 \pm 1.363 (-2.188;3.228)	0.7280
bump1_O	-1.082 \pm 2.005 (-5.139;2.825)	0.5502
bump2_L	-0.484 \pm 0.487 (-1.473;0.464)	0.2628
bump2_H	0.568 \pm 0.751 (-0.978;2.007)	0.4414
bump2_O	-0.541 \pm 0.584 (-1.679;0.643)	0.4033

B)

Trait	$\beta \pm SE$ (95% CI)	P_{10k}
trunk_L	1.319 \pm 0.493 (0.359;2.317)	0.011
bump1_O	0.074 \pm 0.353 (-0.632;0.771)	0.854
bump2_L	-0.420 \pm 0.305 (-1.038;0.173)	0.255

body size ($\beta = 1.022$ vs. 0.703), both selection gradients were statistically significant ($P_{10k} = 0.0001$ vs. 0.0286).

III.5 DISCUSSION

The study of the elephant seal proboscis was not easy because the proboscis is fleshy, and both its size and shape depend on the motivational status of the male and his behavior, and on social conditions. The combination of direct stimulation by the researcher with photogrammetry was a viable solution to this problem, because it permitted the measurement of the proboscis during male agonistic displays. The high repeatability of proboscis traits measured by photogrammetry means that measured traits can be considered good phenotypic traits. Moreover, the measurement error, although somewhat higher than the usual error for morphological traits (Yezerinac et al., 1992), was small enough to render measurements reliable.

Most or all pinniped species show sexual dimorphism in facial traits (Miller, 1991; Miller and Boness, 1979), and in components of the external respiratory system (e.g. pharyngeal pouches of walrus *Odobenus rosmarus*; hood of hooded seals *Cystophora cristata*; Tyack and Miller, 2001). Facial morphology is a core component of aggressive behavior in elephant seals: during agonistic contests the proboscis is expanded, the mouth is open, and the lower canine teeth are shown (Sandegren, 1976). Of the two main components of male elephant seal facial morphology (i.e., proboscis and canines), the latter seems to not be under directional selection in the Sea Lion Island population. Canine teeth show some sexual dimorphism in many mammal species, and this

dimorphism is related to sexual selection that favors the enlargement of canines when they are used during fights between males (Gittleman and Van Valkenburgh, 1997; Harvey et al., 1978). In pinnipeds, the dimorphism in canine teeth is widespread (Lowry and Folk, 1990), and it is present in both *Mirounga* species (Briggs and Morejohn, 1975; Briggs and Morejohn, 1976). Male elephant seals bite each other during agonistic contests, but the real effect of bites on the outcome of the contest is dubious (Haley, 1994). At SLI (Braschi, 2004) and in the Valdés Peninsula elephant seal population (Galimberti, 1995), contests are determined by strength and stamina of the males, which is in turn related to body size and weight, and bites play a secondary role.

Male exaggerated traits, that seem to produce no advantage from the point of view of natural selection, can be the result of the action of two different sexual selection processes: intra-sexual selection and selection by female choice (Andersson, 1994). These processes may act together on the same trait. In elephant seals, the presence of intra-sexual selection is well established, because males compete for access to and control of females, and competition success is more-or-less determined by male resource-holding potential (Le Boeuf, 1974; McCann, 1981). The resulting opportunity for selection is the highest observed for any vertebrate species (Galimberti et al., 2002).

In contrast, the presence of inter-sexual selection is debated. The basic structure of the elephant seal mating system offers few chances to females to make a direct behavioral choice of mate (Galimberti et al., 2000). Elephant seals have a harem-based mating system and, contrary to what happens in other species with a similar mating system (*e.g.*, red deer *Cervus elaphus*: Clutton-Brock et al. 1982), females have very limited mobility after parturition and, therefore, in the vast majority of cases they mate in the harem where

they gave birth (Galimberti et al., 2000). Contrary to what happens in other species (e.g., gelada *Theropithecus gelada*: Dunbar 1984), females have no role in the process of harem acquisition by males, which depends only on dominance relationships among males. Moreover, at SLI, matings are restricted almost only to harem holders (Galimberti et al., 2002), and harem holders monopolize the vast majority of genetic paternities (Fabiani et al., 2004). Therefore, the mating system imposes a strict constraint on a fundamental process of direct behavioural choice of mate by females, *i.e.*, the free sampling of different males (Beehler and Foster 1988). In the absence of direct behavioural mate choice by females, the observed directional selection on proboscis size must be related to intra-sexual selection. Secondary sexual traits are usually related to body size, which is, by itself, a direct target of intra-sexual selection in many species. Therefore, the direct effect of phenotypic selection on these traits should be assessed by taking body size into account. When secondary sexual traits are the direct target of sexual selection, selection pressures can be in the same direction as selection on size, or not (Barki et al., 1991; Brown and Bartalon, 1986; Feh, 1990). At SLI, the selection gradient on proboscis size was positive and significantly different from zero even when the effect of body length was taken into account.

Most published statements about the functional role of the elephant seal proboscis in male competition are based on anecdotal or indirect evidence. For example, McCann (1981) stated that: “The size of the proboscis increases with age but there is too much variation in its size among adult males for it to be used as a means of assessing relative dominance, as with the horns of some sheep species.” Contrary to this conclusion, I showed that growth of the whole proboscis and its two bumps is linear and sustained up

to age 9, although it is not so thereafter. Therefore, the proboscis can potentially be a reliable signal of male age for some age classes at least, permitting a clear discrimination between sub-adult and adult males. Moreover, most traits of the proboscis showed positive allometry, and their relationship with body size was rather strong. Therefore, the proboscis can be used as an amplified signal of body size. Male southern elephant seals keep their proboscis expanded during the breeding season, but have no specific motor pattern for its exhibition during agonistic contests. In species in which males have horn-like organs, agonistic behavior includes specialized motor patterns to increase the effectiveness of organ display, like the parallel walk (Barrette, 1986; Braza et al., 1986; Clutton-Brock et al., 1979; Jennings et al., 2003). In elephant seals, a side-by-side posture that displays the proboscis best is very rare, occurring in a small minority of interactions (< 1% at SLI, unpublished data; Sandegren 1976). During most of contests, the males are in front of one another, a position that does not permit effective assessment of proboscis size or shape, which can be better evaluated from the side. It seems, therefore, rather unlikely for the proboscis to be mainly an optical signal, apart from being a generic indication of male arousal (McCann, 1981).

Vocalizations are a main component of elephant seal agonistic behaviour (Sandegren, 1976; Sanvito and Galimberti, 2000), and vocalizations are always emitted with the proboscis expanded. Published statements regarding sound production in male elephant seals are contrasting and anecdotal. For the southern elephant, Laws (1953 and 1956) seems to suggest that air pass through the proboscis during vocalizations, producing its evident vibration, and that sounds are affected by resonances in the proboscis diverticula. On the contrary, McCann (1981) stated that: “The proboscis does

not appear to affect sound production either”, but he did not provide any support for his statement. The same contrast in the literature is apparent for the northern species. Bartholomew and Collias (1962) stated that the proboscis has a fundamental role in sound production, and that the development of the individual vocalization pattern depends on the proboscis growth, but without providing any quantitative evidence. On the contrary, Sandegren (1976) completely dismissed the role of the proboscis in sound production, but, again, without providing any compelling evidences. The acoustic properties of the sound emitted are related to the size and shape of the vocal tract (Riede and Fitch, 1999) and the proboscis, being connected to the main vocal tract, increases its length and changes its shape. Therefore, it seems unlikely that the proboscis plays no role in sound production. The relationship between the vocal tract size and body size is the structural basis for vocalizations to be honest signals of male phenotype (Fitch and Hauser, 2002). Recently, a relationship between body size and age, vocal tract length, and formant dispersion has been demonstrated for red deer (Reby and McComb, 2003). In elephant seals, the main part of the vocal tract should be related to body size, but emission of sounds also should be influenced by the extension of the tract represented by the proboscis. The presence of a significant selection gradient on the proboscis after removal of the effect of body size points toward an advantage for males that, having the same body size, have bigger proboscis. An expanded proboscis can be, therefore, a way to “cheat” about actual body size, because by increasing the length of the vocal tract with a big proboscis, some males may be able to emit formants with frequencies lower than expected from body size alone (as the minor formant found for elephant seals in this study, which appears to be nasally emitted: see chapter 7). A study of the relationship

between body size, proboscis size, and frequency structure of the vocalization of SLI males is currently ongoing.

III.6 LITERATURE CITED

- Andersson M., 1994. *Sexual selection*. Princeton: Princeton University Press.
- Arnold S.J., Wade M.J., 1984a. On the measurement of natural and sexual selection: Theory. *Evolution*. **38**:709-719.
- Arnold S.J., Wade M.J., 1984b. On the measurement of natural and sexual selection: Applications. *Evolution*. **38**:720-734.
- Bailey R.C., Byrnes J., 1990. A new, old method for assessing measurements error on both univariate and multivariate morphometric studies. *Systematic Zoology*. **39**:124-130.
- Banks M.J., Thompson D.J., 1985. Lifetime mating success in the damselfly *Coenagrion puella*. *Animal Behaviour*. **33**:1175-1183.
- Barki A., Karplus I., Goren M., 1991. Morphotype related dominance hierarchies in males of *Macrobrachium rosenbergii* (Crustacea, Palaemonidae). *Behaviour*. **117**:145-160.
- Barrette C., 1986. Fighting behaviour of wild *Sus scrofa*. *Journal of Mammalogy*. **67**:177-179.
- Bell C.M., Hindell M.A., Burton H.R., 1997. Estimation of body mass in the southern elephant seal, *Mirounga leonina*, by photogrammetry and morphometrics. *Marine Mammal Science*. **13**:669-682.
- Braschi C., 2004. Confronti agonistici nell'elefante marino del sud: fattori coinvolti e ruolo delle asimmetrie tra due maschi. (Male agonistic behaviour in southern

- elephant seals: factors and asymmetries involved in conflict). (PhD). Roma:
Università La Sapienza.
- Braza F., Garcia J.E., Alvarez F., 1986. Rutting behaviour of fallow deer. *Acta Theriologica*. **31**:467-478.
- Briggs K.T., Morejohn G.V., 1975. Sexual dimorphism in the mandibles and canine teeth of the Northern elephant seal. *Journal of Mammalogy*. **56**:224-231.
- Briggs K.T., Morejohn G.V., 1976. Dentition, cranial morphology and evolution in elephant seals. *Mammalia*. **40**:199-222.
- Brown L., Bartalon J., 1986. Behavioral correlates of male morphology in a horned beetle. *American Naturalist*. **127**:565-570.
- Burnham K.P., Anderson D.R., 1998. *Model selection and inference: a practical information-theoretic approach*. New York: Springer.
- Clinton W.L., 1994. Sexual selection and growth in male Northern Elephant Seals. In: *Elephant seals. Population ecology, behavior, and physiology* (Boeuf B.J.L., Laws R.M. eds). Berkeley (CA): University of California Press; 154-168.
- Clutton-Brock T.H., Albon S.D., Gibson R.M., Guinness F.E., 1979. The logical stag: adaptive aspects of fighting in red deer (*Cervus elaphus* L.). *Animal Behaviour*. **27**:221-225.
- Clutton-Brock T.H., Guinness F.E., Albon S.D., 1982. *Red deer. Behavior and ecology of two sexes*. Chicago: University of Chicago Press.
- Conner J.K., 1996. Understanding natural selection - an approach integrating selection gradients, multiplicative fitness components, and path analysis. *Ethology Ecology & Evolution*. **8**:387-397.

- Cox C.R., Le Boeuf B.J., 1977. Female incitation of male competition: a mechanism of mate selection. *American Naturalist*. **111**:317-335.
- Darwin C., 1859. *On the origin of species by means of natural selection, or, the preservation of favoured races in the struggle for life*, 1 ed. London: John Murray.
- Darwin C., 1871. *The descent of man and selection in relation to sex*, 1 ed. London: John Murray.
- Fabiani A., Galimberti F., Sanvito S., Hoelzel A.R., 2004. Extreme polygyny among southern elephant seals at the Falkland Islands: behavioral estimates and genetic paternity. *Behavioral Ecology*. **15**:961-969.
- Feh C., 1990. Long-term paternity data in relation to different aspects of rank of Camargue stallions, *Equus caballus*. *Animal Behaviour*. **40**:995-996.
- Fitch W.T., Hauser M.D., 2002. Unpacking "honesty": vertebrate vocal production and the evolution of acoustic signals. In: *Acoustic Communication* (Simmons A.M., Popper A.N., Fay R.R. eds). New York: Springer-Verlag.
- Fitzhugh H.A., 1975. Analysis of growth curves and strategies for altering their shape. *Journal of Animal Science*. **42**:1036-1051.
- Galimberti F., 1995. Competizione tra i maschi e selezione sessuale nell' elefante marino del sud (*Mirounga leonina*) della Penisola di Valdés [Intermale competition and sexual selection in southern elephant seals (*Mirounga leonina*) of the Valdés Peninsula; in Italian, with English abstract] (PhD Thesis). Roma: Università degli Studi di Roma "La Sapienza".

- Galimberti F., Boitani L., 1999. Demography and breeding biology of a small, localized population of southern elephant seals (*Mirounga leonina*). *Marine Mammal Science*. **15**:159-178.
- Galimberti F., Boitani L., Marzetti I., 2000. Female strategies of harassment reduction in southern elephant seals. *Ethology Ecology & Evolution*. **12**:367-388.
- Galimberti F., Fabiani A., Sanvito S., 2002. Measures of breeding inequality: a case study in southern elephant seals. *Canadian Journal of Zoology*. **80**:1240-1249.
- Galimberti F., Sanvito S., Boitani L., Fabiani A., 2001. Viability of the southern elephant seal population of the Falkland Islands. *Animal Conservation*. **4**:81-88.
- Gittleman J.L., Van Valkenburgh A., 1997. Sexual dimorphism in the canines and skulls of carnivores: effects of size, phylogeny, and behavioural ecology. *Journal of Zoology London*. **242**:97-117.
- Haley M.P., 1994. Resource-holding power asymmetries, the prior residence effect, and reproductive payoffs in male northern elephant seal fights. *Behavioral Ecology and Sociobiology*. **34**:427-434.
- Haley M.P., Deutsch C.J., Le Boeuf B.J., 1991. A method for estimating mass of large pinnipeds. *Marine Mammal Science*. **7**:157-164.
- Harvey P.H., Kavanagh M., Clutton-Brock T.H., 1978. Sexual dimorphism in primate teeth. *Journal of Zoology London*. **186**:475-485.
- Hochberg Y., Benjamini Y., 1990. More powerful procedures for multiple significance testing. *Statistics in Medicine*. **9**:811-818.

- Jennings D.J., Gammell M.P., Carlini C.M., Hayden T.J., 2003. Is the parallel walk between competing male fallow deer, *Dama dama*, a lateral display of individual quality? *Animal Behaviour*. **65**:1005-1012.
- Koops W.J., 1986. Multiphasic growth curve analysis. *Growth*. **50**:169-177.
- La Barbera M., 1989. Analyzing body size as a factor in ecology and evolution. *Annual review of ecology and systematics*. **20**:97-117.
- Laws R.M., 1953. The elephant seal (*Mirounga leonina* Linn.). I. Growth and age. *Scientific Reports of the Falkland Island Dependencies Surveys*. **8**:1-62.
- Laws R.M., 1956. The elephant seal (*Mirounga leonina* Linn.). II. General, social, and reproductive behaviour. *Scientific Reports of the Falkland Island Dependencies Surveys*. **13**:1-88.
- Le Boeuf B.J., 1974. Male-male competition and reproductive success in elephant seals. *American Zoologist*. **14**:163-176.
- Le Boeuf B.J., Laws R.H., 1994. Elephant seals: an introduction to the genus. In: *Elephant seals. Population ecology, behavior and physiology* (Laws B.J.L.B.R.M. ed). Berkeley, CA: University of California Press; 1-26.
- Legendre L., Legendre P., 1998. *Numerical ecology*, 2 ed. Amsterdam: Elsevier.
- Lessells C.M., Boag P.T., 1987. Unrepeatable repeatabilities: a common mistake. *Auk*. **104**:116-121.
- Lowry M.S., Folk R.L., 1990. Sex determination of the California sea lion (*Zalophus californianus californianus*) from canine teeth. *Marine Mammal Science*. **6**:25-31.
- Manly B.F.J., 1991. *Randomization and Monte Carlo methods in biology*. London: Chapman and Hall.

- McArdle B.H., 1988. The structural relationship: regression in biology. *Canadian Journal of Zoology*. **66**:2239-2339.
- McCann T.S., 1981. Aggression and sexual activity of male Southern elephant seals, *Mirounga leonina*. *Journal of Zoology London*. **195**:295-310.
- McLain D.K., 1986. Null models and the intensity of sexual selection. *Evolutionary theory*. **8**:49-52.
- Miller E.H., 1991. Communication in pinnipeds, with special reference to non-acoustic signalling. In: *The behaviour of the Pinnipeds* (Renouf D. ed). London: Chapman and Hall; 128-235.
- Miller E.H., Boness D.J., 1979. Remarks on display functions of the snouth of the grey seal, *Halichoerus grypus* (Fab.), with comparative notes. *Canadian Journal of Zoology*. **57**:140-148.
- Mitchell-Olds T., Shaw R.G., 1987. Regression analysis of sexual selection: statistical inference and biological interpretation. *Evolution*. **41**:1149-1161.
- Muggeo V.M., 2003. Estimating regression models with unknown break-points. *Statistics in Medicine*. **22**:3055-3071.
- Rawlings J.O., 1988. *Applied regression analysis. A research tool*. London: Chapman and Hall.
- Reby D., McComb K., 2003. Anatomical constraints generate honesty: acoustic cues to age and weight in the roars of red deer stags. *Animal Behaviour*. **65**:519-530.
- Riede T., Fitch T., 1999. Vocal tract length and acoustics of vocalization in the domestic dog (*Canis familiaris*). *Journal of Experimental Biology*. **202**:2859-2867.

- Sandegren F.E., 1976. Agonistic behavior in the male Northern Elephant seal. *Behaviour*. **57**:136-158.
- Sanvito S., Galimberti F., 2000. Bioacoustics of southern elephant seals. I. Acoustic structure of male aggressive vocalizations. *Bioacoustics*. **10**:259-285.
- Schluter D., 1988. Estimating the form of natural selection on a quantitative trait. *Evolution*. **42**:849-861.
- Shapiro S.S., Wilk M.B., Chen H.J., 1968. A comparative study of various tests of normality. *Journal of the American Statistical Association*. **63**:1343-1372.
- Siegel S., Castellan N.J., 1988. *Non parametric statistics for the behavioral sciences*. New York: McGraw Hill.
- Sutherland W.J., 1987. Random and deterministic components of variance in mating success. In: *Sexual selection: testing the alternatives* (Bradbury J.W., Andersson M.B. eds). Chichester: Wiley; 197-207.
- Trexler J.C., Travis J., 1993. Nontraditional regression analysis. *Ecology*. **74**:1629-1637.
- Tyack P., Miller E.H., 2001. Vocal communication and anatomy in marine mammals. In: *Evolutionary biology of marine mammals* (Hoelzel A.R. ed). London, England: Blackwell.
- Yezerinac S.M., Loughheed S.C., Handford P., 1992. Measurement error and morphometric studies: statistical power and observer experience. *Systematic Biology*. **41**:471-482.

IV - Observational evidence of vocal learning in southern elephant seals: a longitudinal study

(In press in *Ethology*)

IV.1 ABSTRACT

Vocal learning in mammals is sparsely documented, and there is almost no published evidence for vocal learning by wild mammals. In particular, there is no information based on longitudinal data for recognized individuals, even for well-studied highly social species in which vocal communication is an important aspect of social life. I present such information for the southern elephant seal (*Mirounga leonina*). I studied a small breeding population on the Falkland Islands over 8 years (1995-2002). I recorded ~2400 vocalizations from ~285 different males, including many recorded over >1 breeding season (55 males were recorded for >2 yr and 29 were recorded throughout vocal development). Vocalizations are a key element of male agonistic behaviour in this species, the world's most highly polygynous of all vertebrates. For the male agonistic vocalizations, I show that each male emits only one type of vocalization and: (1) a limited number of discrete vocal types exists; (2) the proportions of vocal types change over time; (3) the trends of increase or decrease of the different vocal types is well in accordance with a process of vocal imitation by younger peripheral males of the vocal types of older main breeders.

IV.2 INTRODUCTION

Vocal-production learning, i.e. the modification of the structure of vocalizations as a result of imitation of other individuals, is widespread and well known in birds (Boughman and Moss, 2003; Janik and Slater, 1997; Janik and Slater, 2000). It occurs in different ways and for different adaptive reasons, including recognition at different levels (individual, family, group, population, species), selection of social (often sexual) partners, and habitat matching (Janik and Slater, 1997). On the contrary, evidence for vocal learning in mammals is scanty. The capacity to imitate natural and artificial sounds has been demonstrated for various captive and semi-wild mammals (Boughman, 1998; Eaton, 1979; Poole et al., 2005; Ralls et al., 1985), but documentation of intra-specific copying of natural, socially relevant, sounds by specific individuals is very scarce for wild populations (Crockford et al., 2004).

Vocal-production learning may be particularly important in marine mammals because of their longevity and the complexity of their social systems. Group-specific vocalizations of some cetacean species (in particular within matrilineal groups), have been explained by vocal learning and cultural transmission (Deecke et al., 2000; Noad et al., 2000; Whitehead, 1998). However, such inferences are based on indirect evidence, not on longitudinal data for individually recognized animals. In this paper I provide the first evidence of vocal-production learning in a marine mammal, the southern elephant seal (*Mirounga leonina*), using a longitudinal data set.

Northern (*M. angustirostris*) and southern elephant seals are the most polygynous of all mammals, with a mating system based on harem defence and strong competition

among males for access to females (Galimberti et al., 2002). Male elephant seal agonistic vocalizations are one of the most important components of inter-male competition, and are likely to communicate information about the resource holding potential of the emitter (Bartholomew and Collias, 1962; Sanvito and Galimberti, 2003; Shipley et al., 1981; Shipley et al., 1986). In both species, mature male agonistic vocalizations are structurally complex, stereotyped, and individually distinctive, and each male emits only one kind of agonistic vocalization, as identified by the specific arrangement of syllables and syllable parts (Sanvito and Galimberti, 2000b; Shipley et al., 1981).

Some structural aspects of vocalizations may be learned because (1) young elephant seals have plastic vocalizations that become increasingly structured with age, and (2) vocalizations seem to change geographically (Le Boeuf and Petrinovich, 1974 a; Sanvito and Galimberti, 2000b). The presence of dialects in different breeding colonies is consistent with vocal-production learning but does not demonstrate its existence (Egnor and Hauser, 2004). Data on geographic variation are cross-sectional in nature and could by themselves be explained by founder effects and sampling bias, without requiring a vocal-production learning process (Le Boeuf and Peterson, 1969; Le Boeuf and Petrinovich, 1974 a; Sanvito and Galimberti, 2000b).

My first hypothesis was that a main factor in vocal development of male elephant seals is imitation of the syllable patterns of the structured vocalizations of older males. Elephant seals spend most of their lives at sea, where they are solitary and silent (Fletcher et al., 1996). When on land during the period of moult, elephant seals rarely interact overtly or vocalize, aside from play-fighting between juveniles (personal observations; Laws, 1956). Therefore, the only good opportunity for young males to learn vocalizations

is during the breeding season. Harem holders, which usually, but not always, are the oldest males, vocalize frequently to keep peripheral males away from females (McCann, 1981). These vocalizations are the dominant component of the acoustic habitat of young males. Large harems have the greatest number of associated peripheral males (Galimberti et al., 2000a), so my second hypothesis was that males holding large harems will influence vocal learning disproportionately. As a result, vocal types of the most successful holders should gradually increase in the population.

In this paper I show that vocal types in southern elephant seals, as recognized from visual inspection of waveforms and spectrograms, present large differences in acoustic structure that enable their reliable classification. I demonstrate that the relative frequencies of vocal types in the population change over the years, and I show that this change is very likely the result of propagation of new types through imitative learning of the older, more successful, breeders by the younger peripheral males.

IV.3 METHODS

Data were collected during 8 breeding seasons (September-November, 1995 to 2002) at Sea Lion Island (Falkland Islands), which shelters a small and localized population of about 550 breeding females and 60 breeding males (Galimberti et al., 2001). All males were marked with tags and dye marks and were individually recognized (Galimberti and Boitani, 1999). Marking of seals was carried out by surprise, with no physical or chemical restraint. Seals were tagged in the context of a long term mark-recapture study (Galimberti and Boitani, 1999), using numbered Jumbo Rototags (Dalton Supplies Ltd,

Henley-On-Thames, Oxon, UK), which are the suggested tag model for marking of Antarctic seals (Erickson et al., 1993). Tags were placed in the inter-digital membrane of the hind flippers. These tags have a very small size and weight (length = 45 mm; maximum width = 18 mm; thickness = 2 mm, 3.5 mm near the hole; pivot length = 20 mm; weight = 2 grams) and, due to their elongated shape, should not affect the flippers hydrodynamic performance. They are a very effective way of marking seals (Testa and Rothery, 1992), and their loss rate is very low (Galimberti and Boitani, 1999). Pain involved in tagging is very short lasting. Notwithstanding the large re-sighting effort spent along the years, I never observed any sign of infection due to tagging; I have no indication of any long term detrimental effects. Wounds due to lost tags always healed. Dye marking was carried out using black hair dye approved for human use (New Rollcolor Creme Professional 1N, Nuova Ropel, Genova, Italy). Dye marking was carried out on resting animals, produces no pain at all, has no adverse effect on the animals, and the marks are lost during the moult a few months after the breeding season. A full technical account of the research protocol and a specific report on the ethical background of the research are available on-line (www.eleseal.it/es_lit.htm).

Audio recordings of male aggressive vocalizations (Sanvito and Galimberti, 2000a) were obtained by standard solicitation, in which a person approached the animal, eliciting the typical stereotyped aggression pattern that the seals use during natural encounters with other males, which comprises the emission of the aggressive vocalization (Sanvito and Galimberti, 2000a). I recorded 103 hours of vocalizations from males of all age classes, from 3 to 16 years old (typically I considered juveniles those animals from 3 to 5 years old, subadults from 6 to 9 years old and adults 10 years old and older; see also

Clinton, 1994), with 1 to 64 vocalizations recorded per male per year (total = 7405 vocalizations). To obtain balanced samples, I randomly selected 5 recordings per male per year, except in 2002, for which I analyzed two vocalizations per male per week, for a total of 2380 vocalizations from 284 different males, with some males present in more than one breeding season (range 1-6 seasons; mean = 1.7 ± 1.1). Fifty-five males were recorded over 3 or more years, and 29 were followed throughout their entire vocal development, beginning from when they exhibited plastic, non-structured vocalizations to fully structured adult calls. Males were defined as “holders”, *i.e.*, males that had almost exclusive access to females of their harem during the breeding season, and “peripherals”, *i.e.*, males that were present in the breeding areas and stayed around harems, trying to get access to females, but rarely succeeding in doing so (Galimberti et al., 2000a).

Sounds were recorded on DAT, digitally transferred to a computer, and analyzed with Canary software (v. 1.2; Macaulay Library, Cornell Laboratory of Ornithology, Ithaca, New York). I used the following settings for spectral analyses (Charif et al., 1995; Sanvito and Galimberti, 2000a): Hamming window function with frame length of 21.33 ms (1024 pts) and corresponding filter bandwidth of 190.31 Hz; frame overlap of 50% with time-grid resolution of 10.67 ms; and frequency-grid resolution of 11.72 Hz (FFT = 4096 pts).

Male aggressive vocalizations are composed of a series of sound emissions called pulsing bouts (bouts hereafter, for brevity), which are repeated in sequence a certain number of times (Figure IV.1). Each bout is further subdivided into “syllables” (*i.e.*, a single acoustic event with a continuous spectrographic trace with respect to the time axis) and “syllable parts” (*i.e.*, that portion of a syllable characterized by constant pulse rate). A

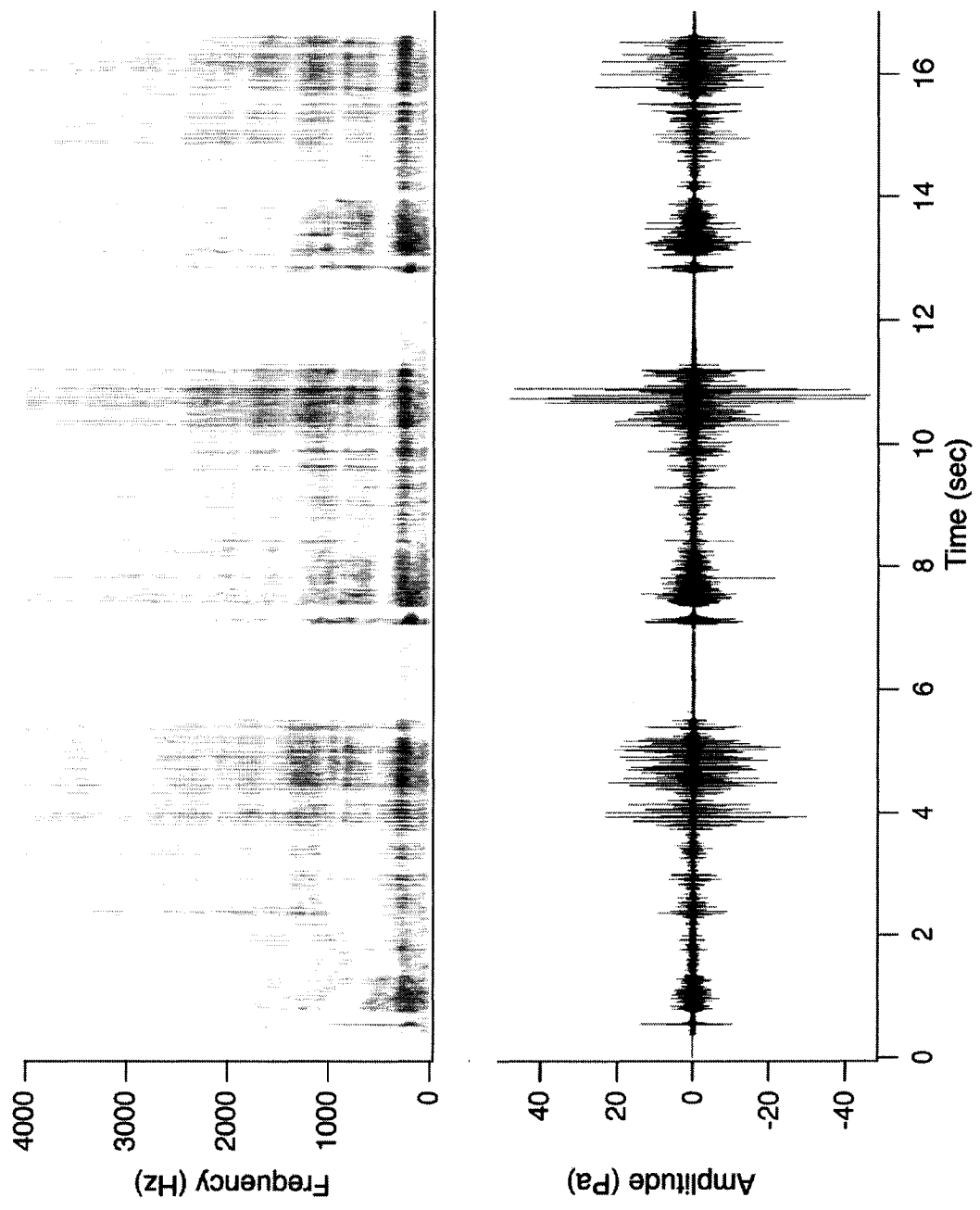

Figure IV.1 – Male elephant seal vocalization, composed of three bouts

detailed description of male aggressive vocalizations acoustic structure is available elsewhere (Sanvito & Galimberti 2000a). Each vocalization was classified as a vocal type by visual inspection of waveforms, using features of bout duration, plus overall diversity and temporal patterning of syllables and syllable parts. The main vocal types recognized in this study are shown in Figure VI.1.

For each vocalization, I measured 15 variables, from waveforms, spectrograms and power spectra, which have been used in my previous studies (full details on sound processing and measurement in Sanvito & Galimberti 2000a and 2000b): number of bouts per vocalization; bout duration; total vocalization duration; relative peak time (= ratio between absolute peak time, *i.e.*, the time from the beginning of the bout at which the highest amplitude in the bout occurs, and the bout duration); duration of syllable part with maximal peak pressure; relative peak intensity (= ratio between peak intensity per hertz, *i.e.*, the maximum intensity/Hz in the bout, calculated from the spectrogram, and peak pressure, *i.e.*, the pressure in the selected bout that has the maximum absolute value, calculated from waveform); peak frequency; fundamental frequency; dominant frequency; first formant; 12 dB bandwidth; minimum frequency at -12 dB; number of syllables per bout; syllable rate; and number of syllable types per bout. I calculated 8 more new variables from power spectra: 12 dB bandwidth proportion occupied by signal (proportion of frequency bandwidth in which spectrum exceeded threshold amplitude of -12 dB); dominance of peak intensity (ratio of relative average intensity of whole bout to peak pressure); energy below 1 kHz (area of power spectrum below 1 kHz, as per cent of total spectrum); power spectrum total slope (slope of regression line fitted through whole spectrum, from 0 to 24 kHz); power spectrum ascending slope (slope of regression line

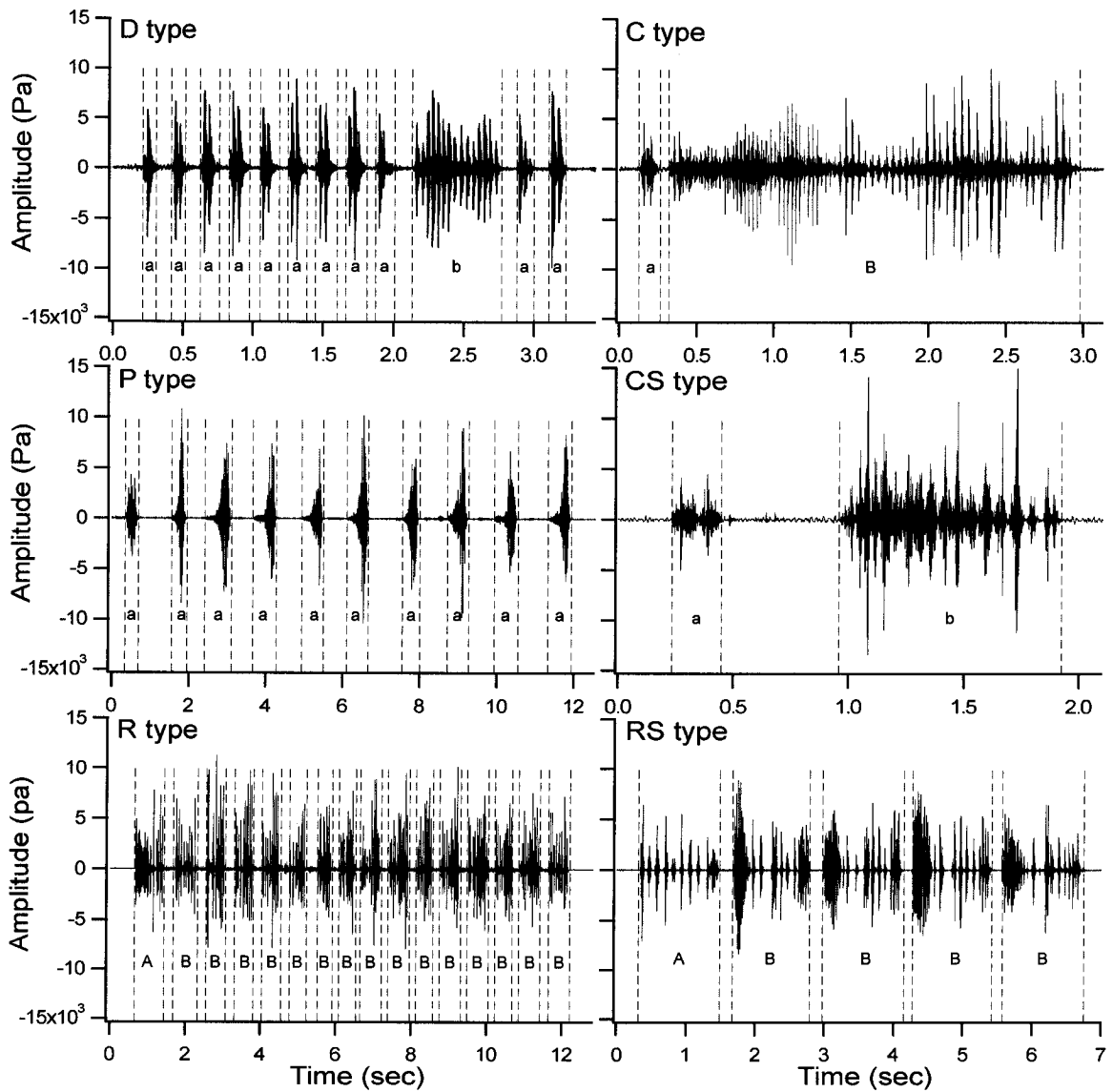

Figure IV.2 - Vocal types differed greatly in temporal attributes, frequency attributes, syllable diversity, and syllable organization. Waveforms of a typical bout of each of the six main vocal types are shown: D = drumming; C = continuous; CS = continuous simplified; R = repetitive; RS = repetitive slow; P = pulsing. Note the different time scales for different vocal types. Each bout is divided into its syllables. Small letters indicate syllables in which the pulse rate is constant (i.e. F₀ is constant), while capital letters indicate syllables in which the pulse rate changes (i.e. they are made of more than one syllable part). Equal letters indicate the same syllable type within each bout (i.e. an "A" syllable of the R type is not the same as an "A" syllable of the RS type).

fitted through spectrum, from beginning to peak) and its coefficient of determination (= the proportion of variance explained by the relationship, R^2); power spectrum maximal amplitude to 4 kHz slope (slope of regression line fitted through spectrum, from peak to 4 kHz) and its coefficient of determination (R^2).

To compare acoustic structure among vocal types I used a non-parametric MANOVA with Bray-Curtis distance and Monte Carlo test (Anderson, 2001). To test the observed vs. expected variation in proportions of different vocal types among years (see results), I used non-parametric exact tests. When I expected a decreasing or increasing trend I used a Cochran-Armitage trend test (Armitage, 1955). When I expected a bell-shaped trend, with a gradual increase, a plateau, and then a gradual decrease, I used a permutation test with arbitrary scores (Good, 1994), with monotonic increasing scores for the first three years, equal scores for the two middle years, and monotonic decreasing scores for the last three years.

When the calculation of exact probability was not feasible, I calculated a Monte Carlo approximation (Manly, 1997). Data exploration, basic statistics, and discriminant analysis were performed in SPSS (version 11, SPSS Inc., www.spss.com). Exact and Monte Carlo tests were performed in StatXact (version 4, Cytel Corporation Inc., www.cytel.com).

IV.4 RESULTS

Vocalizations were present in 68.6% of 31236 agonistic interactions between males. For each interaction I determined the behavioural module that was shown by the winner

immediately before the retreat of the loser. I defined this behavioural module as the module that “settled the contest”, to separate the effect of different signals (e.g., optical vs acoustical). Vocalization settled 48.3% of the agonistic interactions (see Galimberti et al. 2003 for rationale). Vocalization was very often a uni-directional process, with the actor (= the initiator male) vocalizing in 98.0% of cases, and the reactor in just 6.0%. The acoustic environment of younger males was overwhelmingly determined by the aggressive vocalizations of harem holders. Harem holders were involved in 57% of all social interactions. In 76.2% of the interactions in which a vocal component was present, a harem holder was vocalizing. In the interactions involving a harem holding male, it vocalized in 75.5% of cases.

I recognized six main vocal types shared by two or more males over 8 years (Figure IV.2). Bouts of the pulsing (P), repetitive (R) and repetitive slow (RS) vocalizations generally were longer than the bouts of the other types. Bouts of the drumming (D), P and R vocalizations were characterized by many syllables, whereas continuous (C) and continuous simplified (CS) bouts generally had only 2 - 3 syllables; RS bouts were intermediate. C and CS vocal types were similar to one another in macrostructure (*i.e.*, the arrangement of syllables and syllable parts within the bout). CS was the simplest vocal type and was a simplified version of C, with the same number and pattern of syllables (one short syllable followed by one or two longer ones), but a less complex frequency structure (longer syllables had only one syllable part in CS and 3 or more in C). Of the vocal types with many syllables, D was characterized by the repetition of 1 -2 short uniform syllables, plus a single longer one towards the end of the bout, all with uniform pulse rates (they were made of one part only). P type consisted only of a

series of one kind of brief syllable with constant pulse rate, repeated many times, slowly, at a constant rate (approximately 1.1 syllables per second). R and RS types were similar one another, with one initial syllable (that might differ among males) followed by the repetition of a complex syllable made of different parts. The repeating syllables were briefer, more numerous, and repeated faster in R than in RS, imparting a slower rhythm to the latter. Some males had structured vocalizations that were not shared with any of the other males recorded (UNQ, for unique), with varied patterns of syllables and syllable parts. Finally, some males (mostly < 6 yr of age) had no fixed structured vocal pattern (“non-structured” vocalizations hereafter), and their bouts had variable patterns of syllabic structure; in this case the same male was emitting bouts with very different and randomly changing syllable patterns, while males with structured vocalizations always emit the same syllable pattern. Once a male reached vocal maturity (*i.e.*, its vocalizations became “structured”), he always emitted only one type of vocalization (*i.e.*, the same syllable pattern), and no male changed vocalization type during its life. Before reaching this stage, it was not possible to recognize specific vocal types, since syllable patterns were always changing. Variations on vocal types were present, but the patterns were distinct enough to allow unequivocal and repeatable classification of types by visual inspection. Reliability of vocal-type classification was in fact high. In a blind recognition trial, in which the operator was asked to classify the same sound of a set of 20 for three times with a randomized presentation of them, classification was congruent in 100% of cases.

Vocal types differed greatly, based on non-parametric MANOVA with 23 variables (10000 resamplings; $p = 0.0001$). Each variable, except vocalization duration,

was significantly different among types (univariate ANOVAs with randomization test, 10000 resamplings, sequential Bonferroni correction with Holm (1979) method; $p < 0.05$ in each case). Variables that differed most among vocal types were related to bout macrostructure (syllable rate, number of syllables and number of types of syllables) and simple temporal attributes of bouts (bout duration; duration of syllable part with maximal peak pressure). Finally, frequency, intensity, and power spectra “shape” variables differed among vocal types, indicating that the differences in macrostructure were also related to differences in the frequency domain.

Discriminant analysis with cross-validation achieved good classification success, with a mean of 82.1% of vocal types classified correctly, *i.e.* in the same vocal type as the visual classification (57.9-93.3% for different vocal types). D and B types were classified best (85.9% and 93.3% respectively); these have a distinctive and simple macrostructure, with brief syllables and constant pulse rate (Figure VI.1). The worst performance was for the C and RS types (57.9% and 58.9% respectively), which have complex long syllables and variable pulse rate (Figure VI.1). Types C and CS partially overlapped because CS was a simplified version of C, with the same number and pattern of syllables, but less complex frequency structure.

Mature males had structured vocalizations and retained their vocal types over successive years, whereas young males had non-structured vocalizations (Sanvito and Galimberti, 2000b). The proportion of males with non-structured vocalizations decreased with age, from 100% at age 3 to 1% at age 10 (Figure VI.3; Exact Cochran-Armitage test for trends in proportions: trend parameter = -0.8654, 95% exact confidence interval = -1.073, -0.6742; $p = 0.0001$).

I tested the hypothesis of imitation of harem holders by comparing the observed frequencies of vocal types in the eight years of study with the frequencies expected from the appearance and disappearance of successful males with particular vocal types. I hypothesized that new vocal types should arise in the population, and their spread would depend on the competitive success of males using these types, because males holding large harems would be imitated by many young males. The process could be amplified if any of the young imitators became themselves harem holders, whereas the vocal type would disappear from the population through natural mortality of the males showing that vocal type, if it is not imitated or is imitated only by young males that later fail to hold a harem. Hence, I expected (1) frequencies of vocal types to change over years; (2) the oldest vocal types (types C and D, already present in the population at the beginning of my study) to be at some point of the increasing/decreasing trend of vocal types' appearance, showing either a bell-shaped or a decreasing trend in their frequencies; (3) new vocal types to appear in the population and spread if they belonged to reproductively successful males

Frequencies of vocal types were not homogeneous among years (Chi-square test for independence, with randomization: $\chi^2 = 184.2$; $p_{10k} = 0.0001$). Observed proportions of males with different vocal types, expected variation, and corresponding statistical results, are shown in Table VI.1. All observed trends in proportions of different vocal types were statistically different from zero, and in accordance with my expectations.

Vocal type D was the most common of the old vocal types and showed a bell-shaped trend, according to our hypothesis; it was still present in the population, although at low frequency, 2 years after the end of this study (personal observations). The other old vocal

type, C, was decreasing when I started the study and has disappeared from the population. New vocal types appeared and some have spread in the population. For example, type R had a particularly clear pattern of spread in the population. It was noted first in male APRIM; during the 1999 and 2000 breeding seasons he was a subadult (6 and 7 years old respectively) peripheral male with low breeding success, and was the only male with vocal type R. In 2001 he was an 8-year-old subadult and became harem holder briefly; again he was the only male with vocal type R. In 2002 he became holder of the main harem of my study site, with 6-8 peripheral males in attendance on different days. During that breeding season, vocal type R was uttered by several subadult males that had non-structured vocalizations in the previous year, and one of them held a small harem later that season, furthering the process of spread (Table VI.1). Vocal types CS and RS followed a similar pattern: initially they were unique, then they spread after the males that used them became main breeders. Seven (12.5%) of the 56 males with unique vocal types in my study were harem holders in one or more seasons. Four of them became holders of main harems with many peripheral males, and in all cases their vocal types spread subsequently. Each of the other three males was present for only one season with a marginal small harem, and their vocal types were not imitated by any other male, hence disappeared from the population with them. None of the males with unique vocalizations that died before becoming a harem holder were imitated by other males.

In a sample of 21 young males previously recorded with non-structured vocalizations, and that showed a stable association with a specific harem holder during the breeding season (based on individual daily records), 57.1% adopted the vocal type of the holder (Exact binomial test, with expected proportion = $1/7 = 0.1429$: $p < 0.0001$;

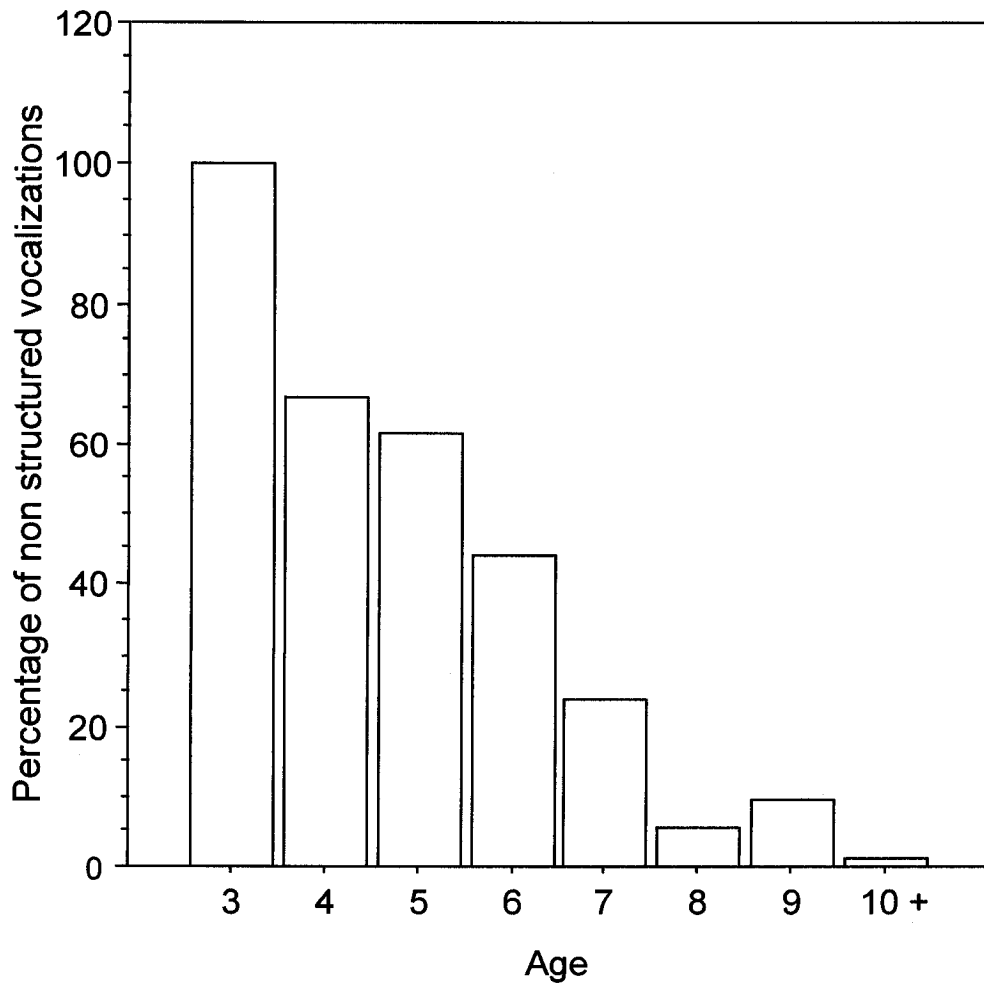

Figure IV.3 - Vocalizations changed from non-structured and variable to structured and stereotyped over development. Bar diagram shows per cent of males with non-structured vocal types for each age (year) class.

Table IV.1 - Percentages of vocal types changed over the 8-year study. The last column indicates the number of males with structured vocalizations in each breeding season. Initially only vocal types C and D were present, but these declined in frequency and nearly disappeared as new vocal types appeared and spread. I used exact permutation tests with scores increasing then decreasing to test the bell-shaped trend for vocal type D, and Cochran-Armitage exact-trend test for increasing or decreasing trends for other vocal types (observed trend parameters and exact p values for each test are shown)

Breeding season	D	C	CS	P	R	RS	n
1995	67.7	32.3	0.0	0.0	0	0	31
1996	53.8	41.0	2.6	0.0	0	2.6	39
1997	65.1	25.6	2.3	4.7	0	2.3	43
1998	75.5	12.2	2.0	4.1	0	6.1	49
1999	62.0	16.0	6.0	4.0	2	10	50
2000	65.5	1.8	7.3	7.3	1.8	16.4	55
2001	52.2	0.0	13.0	13.0	4.3	17.4	23
2002	19.4	3.2	19.4	16.1	29	12.9	31
Expected pattern	Bell-shaped	Decreasing	Increasing	Increasing	Increasing	Increasing	
Obs trend parameter	0.0027	-0.499	0.481	0.443	1.340	0.366	
Exact p		0.0000	0.0002	0.0007	0.0007	0.0005	

95% exact confidence limits for the proportion: 0.3402 - 0.7818). It should be noted that the 1/7 expected proportion is conservative, because all males adopting a specific vocal type, not shared by anybody else, are pooled in the UNQ vocal type. Therefore, in the calculation of the expected proportion, a male that adopted a UNQ vocal type, and which harem holder also had a UNQ vocal type, is counted as adopting the same vocal type of his harem holder, which is not the case since UNQ types are different from one another by definition.

IV.5 DISCUSSION

Vocal learning and imitation of the macrostructure of conspecific vocalizations can explain my observations on temporal changes in male elephant seal vocal types. Other explanations are possible but rather unlikely, due to the constraints of the breeding biology and social system of my study population. For example, the vocal pattern could be inherited. In my study, however, none of 6 males with known father (as determined by microsatellite analysis, Fabiani et al., 2004), inherited its vocal type (unpubl. data). Therefore, it is rather unlikely that the vocal type has a strong genetic determination. The spread of new vocal types also could result from repeated or multiple immigration of individuals from other populations that differ vocally (Le Boeuf and Petrinovich, 1974b), but at Sea Lion Island immigration of breeding individuals is extremely rare (Fabiani et al., 2003; Galimberti and Boitani, 1999). In addition, my results are based on individuals with very well known breeding history, so the bias due to undetected immigration, if any, should be small. In conclusion, vocal learning by imitation of the most successful

breeding males (*i.e.*, those holding the largest harems) is the most reasonable and parsimonious explanation for my observations.

Experimentation, including playback, often is used to study vocal learning (Janik & Slater, 2000; Nelson, 2000; Schusterman, 1978), but is not always applicable in natural settings. Hence Rendell and Whitehead (2001) advocated an “ethnographic” approach, using observed vocal variation within and across conspecific social groups that cannot be explained by genetic or environmental factors. Application of this approach to marine mammals has uncovered vocal variation at different social and spatial levels (Noad et al., 2000; Rendell and Whitehead, 2003; Van-Parijs et al., 2003). The indirect and suggestive evidence for vocal learning offered by this approach can be strengthened by longitudinal data on known individuals, including early stages of vocal ontogeny, as in my study. The evidences I provide are obviously correlational, as in any observational study, but show a rather strong concordance between expected and observed patterns. These observations can, potentially, be strengthened by playback experiments. Unfortunately, this is not a realistic option for wild elephant seals, because the exceptionally high sound level of southern elephant seal vocalizations (Sanvito and Galimberti, 2003) makes very difficult to devise a realistic playback protocol.

A puzzling aspect of elephant seal social behaviour is the presence on land during the breeding season of young and subadult males. These males have almost no chance to reproduce but pay a high cost for attendance because they fast while on land, suffering a substantial loss of body mass (Galimberti et al., submitted). Breeding effort of these males is similar to the one of main breeding males, but their reproductive success is much lower (Deutsch et al., 1994). It has been suggested that fasting costs are offset by gains in

social experience, which may improve competitive abilities in subsequent years (Deutsch et al., 1994). This hypothesis is suggestive, but has never been demonstrated before. At Sea Lion Island, vocal imitation by young male elephant seals through copying of vocal characteristics of other individuals (especially reproductively successful ones), may be an important component of the development of social competence. The breeding ground is the only place where young elephant seals can learn and practice the vocalizations that are so important in their later social life. As noted, seals are solitary and silent when at sea, and interact and vocalize little during the period of terrestrial moult (Fletcher et al., 1996). Moreover, the different age classes differ in when they moult, so young moulting males have few chances to be able to listen to structured vocalizations of older males outside the breeding season (Carrick et al., 1962; Hindell and Burton, 1988; Laws, 1956).

Male elephant seals differ greatly in reproductive success within and across breeding seasons and on a lifetime basis (Le Boeuf and Reiter, 1988). At Sea Lion Island, variation in mating success across males, measured from demographic and behavioural data, is the highest ever recorded for a vertebrate (Galimberti et al., 2002) and is reflected in the distribution of true genetic paternities (Fabiani et al., 2004). Dominance hierarchies show a strong linearity (Galimberti et al., 2003) and access to females is strictly related to competitive success and dominance rank. Therefore, traits related to competition among males are likely under very strong selection. Vocalizations have a key role in establishing and maintaining dominance relationships in elephant seals (McCann, 1981; Sandegren, 1976). Specific features of vocal behaviour that are important in dominance relationships among males are little known. Vocalizations seem to transmit information about the resource holding potential of the emitter (Sanvito and Galimberti, 2003). Therefore, the

copying of syllable structure of the vocalization of a more successful male may be a form of cheating. On the other side, components other than syllable structure of the sound, including frequency and intensity, seems to have a main role in the transmission of information about the male phenotype (Sanvito and Galimberti, 2003; Chapter 5) making unlikely the spread of truly dishonest signals. In any case, vocal communication plays integral roles in the social biology of elephant seals, and vocal-production learning seems to be an important mechanism by which male vocal attributes are acquired. An adaptive basis to the phenomenon could be related to short-term advantages of dishonest signalling, or general longer-term advantages of acquiring vocal types that are familiar to individuals in the population. However, female choice does not seem to happen at all in this species (Galimberti et al., 2000b), hence at the actual stage of knowledge, it seems most parsimonious to explain the phenomenon as a non-adaptive by product of the tendency of young males to copy vocalizations of those males that they hear most frequently.

IV.6 LITERATURE CITED

Armitage P., 1955. Tests for linear trends in proportions and frequencies. *Biometrics*.

11:375-386.

Bartholomew G.A., Collias N.E., 1962. The role of vocalization in the social behaviour of the Northern Elephant Seal. *Animal Behaviour*. **10**:7-14.

Boughman J.W., 1998. Vocal learning by greater spear-nosed bats. *Proc. R. Soc. Lond. B.*

Biol. Sci. **265**:227-233.

Boughman J.W., Moss C.F., 2003. Social sounds: vocal learning and development of mammal and bird sounds. In: *Acoustic communication. Springer handbook of auditory research* (Simmons A., Popper, A. N. & Fay, R.R. ed). New York: Springer; 138-224.

Carrick R., Csordas S.E., Ingham S.E., Keith K., 1962. Studies on the southern elephant seal, *Mirounga leonina* (L.). III. The annual cycle in relation to age and sex.

C.S.I.R.O. Wildlife Research. **7**:119-160.

Charif R.A., Mitchell S., Clark C.W., 1995. *Canary 1.2 user's manual*. Ithaca, NY:

Cornell Laboratory Of Ornithology.

Crockford C., Herbinger I., Vigilant L., Boesch C., 2004. Wild Chimpanzees Produce Group-Specific Calls: a Case for Vocal Learning? *Ethology*. **110**:221-243.

Deecke V.B., Ford J.K.B., Spong P., 2000. Dialect change in resident killer whales: Implications for vocal learning and cultural transmission. *Animal Behaviour*.

60:629-638.

- Deutsch C.J., Crocker D.E., Costa D.P., Le Boeuf B.J., 1994. Sex- and age-related variation in reproductive effort of Northern Elephant Seals. In: *Elephant seals. Population ecology, behavior, and physiology* (Boeuf B.J.L., Laws R.M. eds). Berkeley (CA): Un. California Press; 169-210.
- Eaton R.L., 1979. A beluga whale imitates human speech. *Carnivore*. **2**:22-23.
- Egnor R.S.E., Hauser M.D., 2004. A paradox in the evolution of primate vocal learning. *TRENDS in neurosciences*. **27**:649-654.
- Erickson A.W., Bester M.N., Laws R.M., 1993. Marking techniques. In: *Antartic seals. Research methods and techniques* (Laws R.M. ed). Cambridge: Cambridge University Press; 89-118.
- Fabiani A., Galimberti F., Sanvito S., Hoelzel A.R., 2004. Extreme polygyny among southern elephant seals at the Falkland Islands: behavioral estimates and genetic paternity. *Behavioral Ecology*. **15**:961-969.
- Fabiani A., Hoelzel A.R., Galimberti F., Meulbert M.M.C., 2003. Long-range paternal gene flow in the Southern elephant seal. *Science*. **299**:676.
- Fletcher S., Le Boeuf B.J., Costa D.P., Tyack P.L., Blackwell S.B., 1996. Onboard acoustic recording from diving northern elephant seals. *J. Acoust. Soc. America*. **100**:2531-2539.
- Galimberti F., Boitani L., 1999. Demography and breeding biology of a small, localized population of southern elephant seals (*Mirounga leonina*). *Marine Mammal Science*. **15**:159-178.
- Galimberti F., Boitani L., Marzetti I., 2000a. The frequency and costs of harassment in southern elephant seals. *Ethology Ecology & Evolution*. **12**:345-365.

- Galimberti F., Boitani L., Marzetti I., 2000b. Female strategies of harassment reduction in southern elephant seals. *Ethology Ecology & Evolution*. 12:367-388.
- Galimberti F., Fabiani A., Boitani L., 2003. Socio-spatial levels in linearity analysis of dominance hierarchies: a case study on elephant seals. *Journal of Ethology*. 21:131-136.
- Galimberti F., Fabiani A., Sanvito S., 2002. Measures of breeding inequality: a case study in southern elephant seals. *Canadian Journal of Zoology*. 80:1240-1249.
- Galimberti F., Sanvito S., Boitani L., Fabiani A., 2001. Viability of the southern elephant seal population of the Falkland Islands. *Animal Conservation*. 4:81-88.
- Galimberti F., Sanvito S., Braschi C., Boitani L., submitted. The cost of success: reproductive effort in male southern elephant seals. *Behavioral Ecology and Sociobiology*.
- Hindell H.A., Burton H.R., 1988. Seasonal haul-out patterns of southern elephant seal (*Mirounga leonina* Linn.) at Macquarie Island. *Journal of Mammalogy*. 69:81-88.
- Holm S., 1979. A simple sequentially rejective multiple test procedure. *Scand. J. Stat.* 6:65-70.
- Janik V.M., Slater P.J.B., 1997. Vocal learning in mammals. *Advances in the Study of Behavior*. 26:59-99.
- Janik V.M., Slater P.J.B., 2000. The different roles of social learning in vocal communication. *Animal Behaviour*. 60:1-11.
- Laws R.M., 1956. The elephant seal (*Mirounga leonina* Linn.). II. General, social, and reproductive behaviour. *Scient. Rep. Falkland Is. Depend. Surv.* 13:1-88.
- Le Boeuf B.J., Peterson R.S., 1969. Dialects in elephant seals. *Science*. 166:1654-1656.

- Le Boeuf B.J., Petrinovich L.F., 1974 a. Elephant seals: interspecific comparisons of vocal and reproductive behavior. *Mammalia*. **38**:16-32.
- Le Boeuf B.J., Petrinovich L.F., 1974 b. Dialects of northern elephant seals, *Mirounga angustirostris*: origin and reliability. *Animal Behaviour*. **22**:565-663.
- Le Boeuf B.J., Reiter J., 1988. Lifetime reproductive success in northern elephant seals. In: *Reproductive success. Studies of individual variation in contrasting breeding systems* (Clutton-Brock T.H. ed). Chicago: University of Chicago Press; 344-362.
- Manly B.F.J., 1997. *Randomization, bootstrap and Monte Carlo methods in biology*. London: Chapman and Hall.
- McCann T.S., 1981. Aggression and sexual activity of male Southern elephant seals, *Mirounga leonina*. *Journal of Zoology London*. **195**:295-310.
- Noad M.J., Cato D.H., Bryden M.M., Jenner M.-N., Jenner K.C.S., 2000. Cultural revolution in whale songs. *Nature*. **408**:537.
- Poole J.H., Tyack P.L., Stoeger-Horwath A.S., Warwood S., 2005. Elephants are capable of vocal learning. *Nature*. **434**:455-456.
- Ralls K., Fiorelli P., Gish S., 1985. Vocalizations and vocal mimicry in captive harbour seals, *Phoca vitulina*. *Canadian Journal of Zoology*. **63**:1050-1056.
- Rendell L.E., Whitehead H., 2003. Vocal clans in sperm whales (*Physeter macrocephalus*). *Proceedings of the Royal Society Biological Sciences Series B*. **270**:225-231.
- Sandegren F.E., 1976. Agonistic behavior in the male Northern Elephant seal. *Behaviour*. **57**:136-158.

- Sanvito S., Galimberti F., 2000a. Bioacoustics of southern elephant seals. I. Acoustic structure of male aggressive vocalizations. *Bioacoustics*. **10**:259-285.
- Sanvito S., Galimberti F., 2000b. Bioacoustics of southern elephant seals. II. Individual and geographical variation in male aggressive vocalizations. *Bioacoustics*. **10**:287-307.
- Sanvito S., Galimberti F., 2003. Source level of male vocalizations in the genus *Mirounga*: repeatability and correlates. *Bioacoustics*. **14**:45-57.
- Shipley C., Hines M., Buchwald J.S., 1981. Individual differences in threat calls of northern elephant seal bulls. *Animal Behaviour*. **29**:12-19.
- Shipley C., Hines M., Buchwald J.S., 1986. Vocalizations of northern elephant seal bulls: development of adult call characteristics during puberty. *Journal of Mammalogy*. **67**:526-536.
- Testa J.W., Rothery P., 1992. Effectiveness of various cattle ear tags as markers for Weddell seals. *Marine Mammal Science*. **8**:344-353.
- Van-Parijs S.M., Corkeron P.J., Harvey J., Hayes S.A., Mellinger D.K., Rouget P.A., Thompson P.M., Wahlberg M., Kovacs K.M., 2003. Patterns in the vocalizations of male harbor seals. *Journal of the Acoustical Society of America*. 3403-3410.
- Whitehead H., 1998. Cultural selection and genetic diversity in matrilineal whales. *Science*. **282**:1708-1711.

V - Ontogeny of male elephant seal vocalizations: maturation and learning

(Submitted to *Behaviour*)

V.1 ABSTRACT

Male vocalizations are an important component of elephant seal agonistic behaviour. Acoustic and behavioural features of vocalizations show gross differences between young and old males, but the variation with actual age depends on the specific feature. The ontogeny of acoustic features that are independent from structural phenotype should show scant or no relationship with age, while features that are constrained, because they depend on the vocal tract size and shape, should show a development with age. In southern elephant seals, the formants, which are constrained by the vocal tract length and, therefore, by body size, show a clear pattern of reduction in frequency with age (*i.e.* F5 ranges from 2086 Hz for juveniles to 1326 Hz for adults), while temporal and structural features of sounds, which potentially are unconstrained, show no trend. Formants ontogeny seems therefore to be mainly a production of body maturation, and, hence, formants may be reliable signals of age. On the contrary, simpler acoustic features, including temporal features and syllable structure are free to vary, and, hence, may serve as the raw material for vocal learning and individual recognition.

V.2 INTRODUCTION

Vocal ontogeny, *i.e.*, the change in the structure of sound and in the use of vocalizations with growth, is a well established phenomenon in animal communications, and has been demonstrated in many taxa (Snowdon and Hausberger, 1997), including birds at large (Smallwood et al., 2003) and songbirds in particular (Liu and Kroodsma, 1999), various species of primates (Egnor and Hauser, 2004; Elowson et al., 1992; Hammerschmidt et al., 2001), bats (Van Parijs and Corkeron, 2002), dolphins (Tyack, 1997) and cetaceans (Snowdon and Hausberger, 1997). On the other side, there are many occurrences of songs or acoustic features that seem to appear abruptly, without any development phase (Hammerschmidt et al., 2001). The presence of some vocal development during ontogeny has been shown in various species of the *Pinnipedia* (Miller, 1991; Shipley et al., 1986), but most of the information available regards the development of calls in pups during the first phase of life, *i.e.*, in a rather short part of the lifespan (Job et al., 1995).

Southern elephant seal (*M. leonina*, SES hereafter) breed on land during a concentrated breeding season, females gather in large groups (called *harems*), and males compete to establish a more or less linear dominance hierarchy, that regulates the access to breeding females (Galimberti et al., 2003; Le Boeuf and Laws, 1994). The resulting intensity of competition and inequality in breeding success are among the highest recorded for Vertebrates (Galimberti et al., 2002). SES males emit vocalizations during agonistic encounters (McCann, 1981; Sanvito and Galimberti, 2000a) that play a pre-eminent role in the settlement of contests, and in the setup of dominance relationships. Agonistic behaviour of elephant seals has both a conventional and a direct component,

and behavioural sequences includes visual and vocal displays, chases, and direct aggression (McCann, 1981). Although fights are usually involved in confrontation between males with similar resource holding potential (Braschi, 2004), the vast majority of social interactions between males include a vocal display, and a large percentage of contests are settled by vocalization only (Chapter 4). A very important aspect of male competition in elephant seals is the age of the contestants, and the interactions between males of different age classes are usually settled by the vocalizations of the older individuals (Braschi, 2004). Studies by other authors (Sandegren, 1976) and previous preliminary results (Sanvito, 1997) indicated that various behavioural and acoustic features of elephant seals male vocalizations change with age. The ontogeny of vocalizations, and the relationship between their acoustic features and age, suggest that sounds may act as honest signals of the age component of elephant seal male resource holding potential (Fitch and Hauser, 2002).

Vocal ontogeny can be the product of two main processes, the vocal learning of acoustic features (*i.e.*, the within-individual change in acoustic features of vocalizations due to auditory experiences; (Egnor and Hauser, 2004), for example by imitation of older individuals (Chapter 4), and the maturation process due to the change in morphology and body size (*i.e.*, the structural phenotype) during growth that affects the size and shape of the structures used to produce the sounds. Some hypotheses can be formulated about the direction of change of specific acoustic features with growth that may permit us to discriminate between these two processes. Vocal learning should be focused on acoustic features that are not constrained by structural phenotype, such as to be able to develop independently from morphology and size, following the acoustic and social habitat in

which the individual development happens. The vocal learning process is expected to increase stereotypy within individuals, but the mean of a vocal feature may potentially change in any direction because of the lack of constraints. On the other hand, the physical maturation process should be prevalent for acoustics features that depend on morphology and body growth. In this case, a directional change in the mean of the acoustic feature with age is expected, while no increase in stereotypy should happen, since the variation of the feature is constrained mechanically by the individual morphology at any age. Moreover, no specific trend in the among-individuals variability is expected, because the level of variation of acoustic features will depend on the spread of the male structural phenotypes. As a general rule, the morphologically constrained features should reflect the morphological and dimensional variation of the age classes, while learned features should be independent from it. The constrained features should also have smaller within-individual variation than learned features at each age due to the structural constraints.

Although there are some evidences of vocal ontogeny in male northern elephant seals (*M. angustirostris*, NES hereafter, Shipley, (1981); 1986), they are somehow limited due to the small time span in which the data was collected, the small number of acoustic features considered, and the lack of information on the structural phenotype of the individuals involved. The study of the ontogeny of vocalizations requires a longitudinal data set, in which both the structural phenotype and the vocalizations are measured in a sample of recognized males that can be followed during their growth. In this paper I describe the development of vocalizations in a large sample of SES males of a small and localized breeding colony of the Falkland Islands. I analyze the variation with age of acoustic and behavioural features of male vocalizations, I study the change in both

within-individual and among-individuals variability of acoustic features, and I compare the observed ontogenetic trends of features with different level of structural constraints with the expectations of the vocal learning and physical maturation processes.

V.3 METHODS

Data were collected during eight breeding seasons (September-November, 1995 to 2002) at Sea Lion Island (Falkland Islands; SLI hereafter), which shelters a small and localized population of southern elephant seals (Galimberti and Sanvito, 2001), comprising about 550 breeding females and about 60 breeding males. All males were individually recognized, because they were marked with cattle tags during previous breeding seasons, some of them at birth, and the rest upon arrival on land during their first breeding season. All breeding males were also marked with hair dye to permit fast and safe recognition during each breeding season. Further details on the marking protocol may be found elsewhere (Galimberti and Boitani, 1999). The full research protocol of the SLI elephant seal project is available online (www.eleseal.it).

V.3.1 Estimation of age

Age was known for males tagged as pups and estimated with 1 year precision for the other males using external morphology. Both in southern (Galimberti and Boitani, 1999) and northern (Clinton, 1994) elephant seals, the external morphology permits the placement of individual males into age categories. I placed males in 8 age categories based on the scarring of the chest and development of the proboscis, and independently

from body size. Categories ranged from juvenile (JUV1 to JUV3 = 3 to 5 years old, pooled in a single JUV class for the current study) to sub-adults (from SAM1 to SAM4 = 6 to 9 years old) and adults (AD = 10 years old or older). I checked my age categories classification using four criteria: intra-observer reliability, inter-observer reliability, internal consistency, and correspondence with actual age. Reliability was calculated using the Kendall coefficient of concordance, a rank-based measure of agreement (Siegel and Castellan, 1988), on the age category attributed to marked males during a random sample of 10 daily censuses carried out during the three week period around the peak of the breeding season. Mean intra-observer reliability was 0.95, and inter-observer reliability ranged from 0.93 to 0.99 for two to four observers. Congruence of the whole classification was checked using lifetime records of the males that were present for three or more breeding seasons, and by comparing age category to actual age for males tagged at birth. In the analysis where age is involved, I only used males for which I either knew the true age or that have been followed for a number of seasons sufficient to obtain a reliable estimate of age from morphological development (Clinton, 1994). Males were classified as “young” (= up to age 8) and “old” (= age 9 or older).

V.3.2 Sound recording

Recording of male agonistic vocalizations was carried out by standard stimulation of the animals, following the protocol described in Sanvito and Galimberti (2000a). I used portable digital recorders (DAT recorder TCD-D7 and TCD-D100, Sony Inc.) with a frequency response of 20-22000 Hz \pm 1 dB and a dynamic cardioid microphone (Sennheiser MD 441), with a frequency response of 30-20000 Hz. Recordings were

digitized at 48 KHz sampling frequency and 16 bit resolution of the original recording.

I recorded male aggressive vocalizations during the whole three months of the breeding seasons every year. I recorded a total of 103 hours of vocalizations from males belonging to all the age classes, with 1 to 64 vocalizations recorded per male per year, for a total of 7405 vocalizations. From these recordings, I extracted and measured 2007 vocalizations, belonging to 196 different males (402 males/year) of known age, with some males present in more than one breeding season (1 to 6; mean = 1.7 ± 1.1). A total of 55 males were recorded for 3 or more seasons and 29 were followed for their entire vocal development, from the initial unstructured and plastic vocalization to the fully structured, final, vocalization. In order to analyze balanced samples, I randomly selected 5 recordings per male per year, apart from the 2002 season, when I analyzed two vocalizations per male per week to study intra-seasonal variation.

V.3.3 Spectral analysis

I performed spectral analysis by Fast Fourier Transform (FFT; Figure V.1) using the following settings (Charif et al., 1995): Hamming window function with frame length of 21.33 ms (1024 pts) and corresponding filter bandwidth of 190.31 Hz; frames overlap of 50% with a time grid resolution of 10.67 ms; frequency grid resolution of 11.72 Hz (FFT = 4096 pts). I carefully chose the spectral settings to resolve the pulse train structure of the elephant seals vocalizations and to maintain a good frequency resolution (Sanvito and Galimberti 2000 a and b). Along with waveforms and spectrograms, I analyzed the amplitude spectra, computed using the above settings. Since in SES male vocalizations, frequency modulation inside the bout is very scarce (Sanvito and Galimberti, 2000a), I

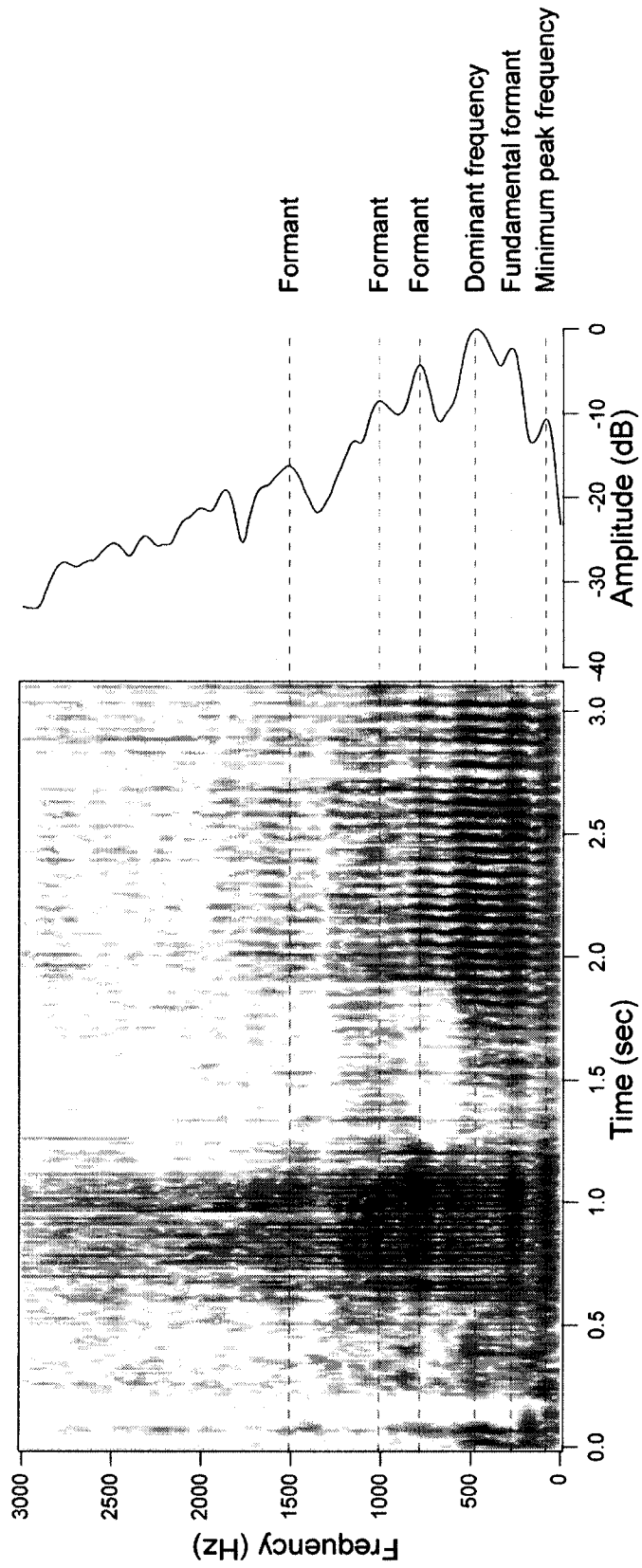

Figure V.1- Spectrogram and average power spectrum of one bout of a male agonistic vocalization

calculated average spectra on the whole duration of each bout (Phillips and Stirling, 2000).

V.3.4 Acoustic measurements

Sound measurement and spectral analysis were carried out using various computer programs, including Canary 1.2 (v. 1.2; Macaulay Library, Cornell Laboratory of Ornithology, Ithaca, New York; <http://www.birds.cornell.edu/brp/SoundSoftware.html>), procedures written in Igor Pro 4.0.9 (WaveMetrics Inc., www.wavemetrics.com), and custom programs written in Revolution 2.0 scripting language (Runtime Revolution Limited, www.runrev.com). Male elephant seals aggressive vocalizations are composed of a series of different numbers of sound emissions, called "bouts", which are further subdivided into "syllables" and "syllable parts" (Sanvito and Galimberti 2000a). A syllable is a single acoustic event, with a continuous spectrographic track, with respect to the time axis. A syllable part is a portion of a syllable characterized by constant pulse rate. Hence, the fundamental frequency is constant in each syllable part.

I considered five classes of variables: temporal, frequency, sound amplitude, energy distribution in frequency and internal structure of bouts. If not differently specified, I always measured the acoustic parameters at the bout level, and then calculated average values for vocalizations and for males for further analysis. I measured many different variables from each bout and vocalization, whose full list is presented below (see Sanvito and Galimberti 2000 for further details on the measurement protocol). Although seismic components of vocalizations may have a role in communication between elephant seal males (Shipley et al., 1992), in this paper I concentrated on

airborne components only.

V.3.4.1 Temporal parameters

The following temporal parameters were measured on the waveform of the vocalizations:

- Number of bouts per vocalization
- Bout length (sec): time between the beginning and the end of a single bout
- Interval between bouts (sec): time between the end of a bout and the beginning of the following one
- Vocalization length (sec): time between the beginning of the first bout and the end of the last bout of a vocalization
- Ratio signal length/total length (sec): ratio between the total duration of all the bouts of a vocalization and the total duration of the vocalization (proportion of vocalization with signal)
- Relative peak time: ratio between absolute peak time (i.e. the time from the beginning of the bout, at which the highest amplitude in the bout occurs) and the bout length
- Syllable part with maximum peak pressure length (sec; Max syllable part hereafter): length of syllable part in which the maximum peak pressure occurs.

V.3.4.2 Intensity parameters

Intensity parameters were measured from average power spectra, spectrograms and waveforms of bouts. All the measures in dB are referred to 20 μ Pa. I only considered relative measures of sound intensity, since I recorded vocalizations from variable distances.

- Instantaneous relative peak intensity: ratio between instantaneous peak intensity per hertz (= the maximum intensity/Hz in the bout, calculated from the spectrogram) and

peak pressure (= the pressure in the selected bout that has the maximum absolute value, calculated from waveform). This variable measures the instantaneous effect of the frequency band with maximum energy on the whole energy emitted on all frequency bands

- Peak intensity predominance: ratio between the relative average intensity of the whole bout and peak pressure. The value varies from 0 to 1. A value of 1 means that the peak of intensity is as intense as the average of the whole bout, whereas lower values indicate the peak of intensity is more and more predominant over the average for the bout

V.3.4.3 Frequency parameters

The following frequency parameters were measured from average power spectra of bouts and from waveforms (see Figure V.2 for details on some of the frequency parameters):

- Dominant frequency (Hz): the frequency at which, on average, the highest amplitude in a bout occurs (calculated as the frequency of the highest peak in the amplitude spectrum of a bout)

- Fundamental frequency (F0 Hz): calculated from the waveform in the predominant "part" of the bout (longer/more intense), as the pulse rate in that part of the bout (Zuberbuhler et al., 1997)

- Peak frequency (Hz): the frequency at which the highest amplitude in a bout occurs, at instantaneous level (calculated on the spectrogram of a bout as the frequency at which the highest amplitude peak occurs)

- 3, 6, 12, 18 dB bandwidth (Hz): width of the frequency band around the dominant frequency where the signal in the amplitude spectrum attenuates by 3, 6, 12, 18 dB (calculated on the average spectrum of a bout by finding two frequencies F_a and F_b

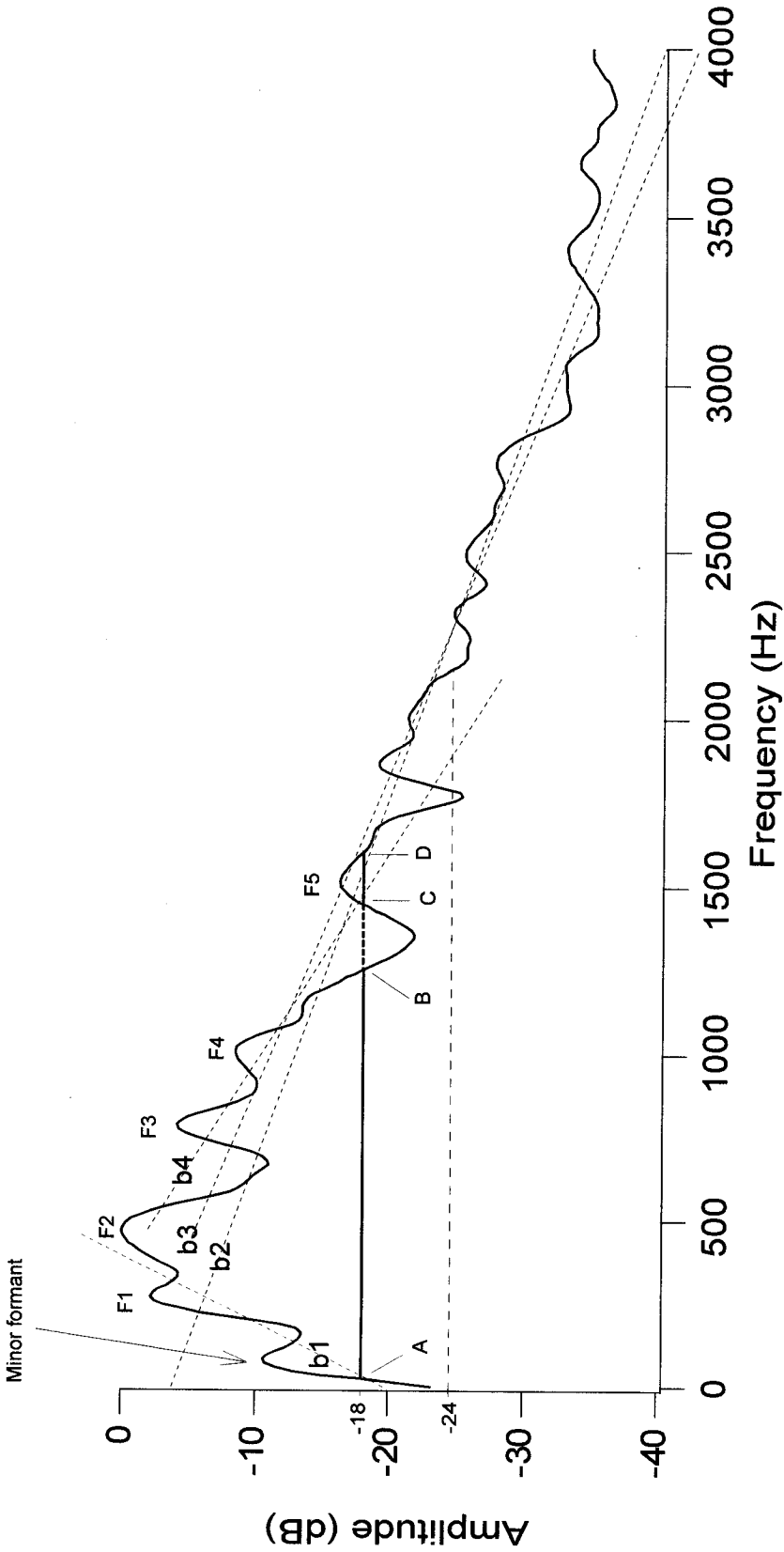

Figure V.2 - Some of the frequency and spectrum overall shape parameters. The frequency of the spectral peaks indicated as F1 to F5 are the formant frequencies. Formant dispersion is calculated as $(F5-F1)/4$. Minor formant is the frequency of the very first spectral peak, usually below 100 Hz, and not always present in the power spectrum. In this case, the dominant frequency occurs at F2. Parameters relative to frequency bandwidth are indicated only for -18 dB. The -3, -6 and -12 dB parameters are estimated in the same way. The frequencies at the points A and C are respectively the minimum and maximum frequency at -18 dB. AD represents the -18 dB bandwidth. The 18 dB bandwidth proportion is calculated as $(AB+CD)/(AD)$. The proportion can be equal to 1 when there are no spectral troughs going below 18 dB from the highest spectral peak, within the -18 dB bandwidth. b1 = power spectrum ascending slope; b2 = power spectrum 0/4000 Hz slope; b3 = power spectrum max amplitude/4000 Hz slope; b4 = power spectrum max amplitude/-24dB slope

around the dominant frequency ($F_a < \text{dominant frequency} < F_a$) where the spectrum level is 3, 6, 12, 18 dB below the peak value; the bandwidth is defined as the difference $F_b - F_a$)

- Minimum frequency at -3, 6, 12, 18 dB (Hz): F_a of the previous definition (i.e., the minimum frequency at which the power spectrum goes 6 dB below the amplitude of the highest peak)

- Maximum frequency at -3, 6, 12, 18 dB (Hz): F_b of the previous definition (i.e., the maximum frequency at which the power spectrum goes 6 dB below the amplitude of the highest peak)

- 3, 6, 12, 18 dB bandwidth proportion occupied by signal (3, 6, 12, 18 bandwidth proportion hereafter): the proportion of the frequency bandwidth in which the spectrum is actually above the amplitude of -3, 6, 12, 18 dB

- Formant like frequencies (F_1 to F_5 hereafter; Hz)

Formants are parts of the frequency spectrum that are “reinforced” by resonant properties of the vocal tract (Miller and Murray, 1995). In spectra and spectrograms of male elephant seal vocalizations there are evident frequencies that are “enhanced” over the others, and appear as dark bands (Sanvito and Galimberti, 2000a). I do not know exactly the specific mechanism that produces these frequencies in elephant seals, but I assume that they are formant-like frequencies, analogous to the true formants observed in human speech (Fry, 1979; Reby and McComb, 2003) and, hereafter, I simply call them “formants” for brevity. Presumably, they reflect the resonant frequencies of the vocal tract, just as they do in humans. Formants were measured from average amplitude spectra, calculated at the male level, as the first 5 evident frequency peaks (F_1 to F_5 ; see below for further details on formant estimation).

- Formant dispersion (Hz): $(F5-F1)/4$. It indicates the average spacing between consecutive formants (Fitch 1997).
- Minor formant (F_m hereafter; Hz): in some cases I founded a very first peak in the power spectrum, at lower frequency and reduced intensity with respect to $F1$ and just preceding it. Its frequency was often below 100 Hz, and in many cases it was not present, or just slightly evident as a “shoulder” on the lower side of the power spectrum.

V.3.4.4 Spectrum overall shape

The energy distribution of a sound (as frequency and amplitude of spectral peaks) is very important in human and animal communication, but also difficult to summarize. Overall spectral shape features encode the global spectrum and might capture the full set of information available in the emitted signal (Owren and Linker, 1992). Hence, I calculated some measures of the overall spectrum shape (Figure V.1):

- Power spectrum ascending slope (Spectrum ascending slope hereafter): the slope of a linear regression line fitted through the spectrum, from the beginning to the maximum peak
- Power spectrum 0/4000 Hz slope (Spectrum 0/4000 Hz slope hereafter): the slope of a linear regression line fitted through the spectrum, from 0 to 4000 Hz
- Power spectrum max amplitude/4000 Hz slope (Spectrum max/4000 Hz slope hereafter): the slope of a linear regression line fitted through the spectrum, from the highest peak to 4000 Hz
- Power spectrum max amplitude/-24dB slope (Spectrum max/-24 dB slope hereafter): the slope of a linear regression line fitted through the spectrum, from the highest peak to the point where the spectrum goes 24 dB below it

V.3.4.5 Internal structure of a bout

The following structural parameters were measured from waveforms and spectrograms:

- Number of syllables per bout: total number of syllables (equal or not) forming each bout
- Syllable rate (syllable/s): number of syllables per second in a bout
- Number of types of syllable per bout: number of different syllables in one bout
- Shannon index: Shannon index of evenness calculated for the syllable composition of the bout to obtain a concise measure about the structural complexity of bouts. I calculated an evenness measure based on the frequency of different kind of syllable in the bout, using the Shannon index divided by the maximum possible index, obtaining a measure independent from the number of syllables (Krebs, 1989).

V.3.5 On estimation of formants

The problem of the objective estimation of formants in animal sounds is still debated. Many different methods has been proposed, going from visual assessment of spectrograms and spectra (Insley, 1992), to the use of Linear Predictive Coding or LPC (Fitch and Reby, 2001; Owren and Linker, 1992; Owren and Bernacki, 1988; Reby and McComb, 2003; Riede and Fitch, 1999), to custom made methods tailored to specific vocalizations (Darden et al., 2003). Although LPC is gaining momentum in animal vocalizations studies (Fischer et al., 2004; Reby and McComb, 2003), I decided to not apply it in my elephant seal study, because the application of LPC requires a pre-established model of the vocal tract, which is not currently available for elephant seals, because the internal anatomy of their tract is almost unknown. Moreover, male elephant seals bear a proboscis which role in the production of vocalizations is uncertain (Chapter

4). The proboscis may have a role in sound production, because it is connected to the oral part of the tract (Laws, 1953; personal observations). This means that the sounds produced at the level of the larynx may potentially be filtered by two resonators that interfere with each other, and this may make a big difference compared to the single resonator mechanism involved in the sound production in other mammals (Fitch, 1997; Fitch and Reby, 2001; Riede and Fitch, 1999). Even in human speech studies, the evaluation of true formants in case of nasal sounds is complicated due to the effect of the nasal tract (Miller et al., 1991; Monsen and Engebretson, 1983).

LPC was originally devised as a sound data compression method, specifically targeted to the streaming coding of human speech (Press et al., 1989), and based on rather strong assumptions about the structure of the sound source and filters. While the estimation of formants on power spectra and spectrograms is based on the filtering properties of the actual vocal tract, the LPC technique extracts formants on the basis of an existing quantitative model of the vocal tract (Markel and Gray, 1976; Robb and Cacace, 1995). If the vocal tract structure is not known in detail, as in my case, both the model and the parameters used in LPC analysis are arbitrary, and the choice of different parameters may lead to completely different and unreliable results. Moreover, a key assumption of LPC is that the signal can be characterized in terms of frequency peaks alone, without paying attention to the spectrum troughs, where frequency energy has been attenuated by vocal tract filtering. Such anti-resonances are likely to occur in elephant seal vocalizations, because the nasal path through the nostrils may play a role in sound production (Owren and Linker, 1992). In conclusion, I decided to avoid applying a strongly parametric method in a situation in which such application is dubious, and to

investigate the energy distribution of my sounds using the traditional non-parametric power spectra obtained by FFT. A parametric method is, in principle, more precise than a non parametric one, because it is intrinsically more efficient at using the quantitative information present in the data, but this increase in precision come at a cost. If the assumptions on which the parametric model is based are not met, *i.e.* the process generating the data is different from the one assumed by the model, the estimates obtained will be precise but the fitting of the data will be poor. Due to the lack of hard data on the mechanism generating the elephant seal sounds, the potential increase in precision gained by LPC is not enough to to balance the risk to fit the wrong model. All together, currently LPC doesn't seem to be a valid alternative for elephant seal formant calculations and energy distribution analysis, and this will hold at least until the internal anatomy of the vocal/nasal tract will be better known.

V.3.6 Modelling of the variation of acoustic features with age

A visual inspection of scatterplots of some acoustic features versus age with fitted LOWESS smoother (Trexler and Travis, 1993) showed a clear bending point in some cases. Therefore, I fitted the following piecewise linear model with unknown bending point (Muggeo, 2003; see also Chapter 3):

$$Trait = a_0 + (b_1 * Age) + (b_d * (Age - BP) * (Age > BP))$$

where BP is the bending point, a_0 is the intercept of the regression line before the bending point, b_1 is the slope of the regression line before the bending point, b_d is the difference in the slope of the regression line before and after the bending point, $Age > BP$ is a logic condition returning 0 for ages $\leq BP$, and 1 for ages $> BP$. Therefore, the slope of the

regression line after the bending point (b_2) is equal to $b_a + b_1$. I tested the difference between the slope before and after the bending point, by testing the null hypothesis $H_0: b_a = 0$ (for which b_1 and b_2 are the same). The piecewise models were fitted using the non-linear least squares module of SYSTAT software (version 11, Systat Inc.). Fitting was carried out using a least squares loss function and the Levenberg-Marquardt algorithm. Asymptotic standard errors were checked using bootstrap; due to the similarity between asymptotic and bootstrapped se I present only the former. Models were compared using the Akaike information criterion (AIC); a difference in AIC equal to or greater than 2 gives a moderate evidence that the model with the lower AIC should be preferred, while a difference ≥ 7 gives a compelling evidence (Burnham and Anderson, 1998).

V.3.7 Measurement error and repeatability of acoustic features

While most acoustic measures were automatically calculated by the analysing software (*i.e.*, in principle without measurement error), the choice of the starting and ending point of each bout was performed manually on the waveforms, and this is a potential source of error than can propagate to all other measures that depend from the bout starting and ending points. To estimate error due to the measurement process each vocalization of a set of 25 was measured three times, in random order. From these measurements, I calculated the measurement error using variance components estimated from a model II ANOVA (Bailey and Byrnes, 1990). Percentage measurement error was calculated as the percentage of the within bout measurement variance on the total variance (= within bout measurement variance + among bouts measurements variance).

I estimated the reliability of all the variables involved in the analysis using the

repeatability (R = intraclass correlation coefficient), which is the proportion of the among individuals variance on the total variance (= among individuals variance + within individuals variance). I calculated the repeatability using variance components from a Model II ANOVA (Lessells and Boag, 1987). I calculated confidence limits of repeatability using a jackknife delete-one procedure, and tested its difference from zero using randomization (10000 re-samplings).

V.3.8 Behavioural data collection and analysis

Data on the development of vocal behaviour were collected during 7852 hours of observation spanning eight breeding seasons, from 1995 to 2002, by 2-5 observers, during standard observation periods of two hours length. A total of 25671 social interactions between males were observed. The actual sequence of the behavioural modules shown by the interacting males was recorded for 5099 social interactions. All males were individually recognizable by dye marks and tags. During each observation period, and for each male present, I recorded the total number of interactions, the number of won interactions, the number of interactions settled by vocalization, the number of interactions in which the male actually vocalized one or more times, the total number of vocalizations emitted, the number of behavioural transitions of each sequence involving the vocalization, and the number of bouts of each vocalization. For each of these variables, I counted the total occurrences, the occurrences when the male was the actor, and the occurrences when the male was the reactor. More details on the behavioural observation protocol can be found elsewhere (Braschi, 2004; Galimberti et al., 2000).

My basic data were counts, which were converted to percentages and means for

presentation, but retained unconverted for the actual analysis. To analyze the change with age of these count variables, I compared for each variable three models suitable for regression on count data (Cameron and Trivedi, 1998; Long, 1997): Poisson regression, negative binomial regression, and zero-inflated negative binomial regression, in all cases fitted by maximum likelihood using the canonical log link function. The Poisson regression is the basic model for count data, but it is suitable only when the mean is approximately equal to the variance. My data showed for all variables a variable degree of over-dispersion, making the negative binomial regression a more suitable model (Gardner et al., 1995). Moreover, due to the social constraints of the presence of older males, younger males may avoid interacting and/or vocalizing at all, and this process may produce an excess of zero counts; therefore, I also considered the zero-inflated variant of the negative binomial, with age as generating variable for the zero inflation process (Cheung, 2002). To avoid biased individual estimates I excluded, for each year, males that were observed for less than 20 hours. To account for the lack of balance in the sampling of males, which was unavoidable due to the different patterns of presence on land of males of different age classes (Galimberti et al., submitted), I incorporated an exposure factor in my regression models using the total number of observation periods in which a male was observed during each breeding season. I tested each model using a likelihood ratio (LR) test of the model including age versus the null model (intercept only). My data set was longitudinal and, therefore, the correlation within individuals may have produced a deflation of standard errors and inflation of significance of statistical tests (Diggle et al., 1994).

Therefore, I calculated robust standard errors (Huber-White sandwich estimator of

variance; Williams, 2000) that take into account the within-male clustering, and I calculated Wald tests on the regression coefficients. The results of the Wald tests were always in accordance with the LR tests, so I present only the latter. The Poisson and the negative binomial regression, which are nested models, can be compared by a LR test, but the negative binomial regression and its zero-inflated variant, which are not nested models, cannot. Therefore, I compared all models using the AIC, which is suitable both for nested and non-nested models. I checked the results of the AIC comparison using two parametric methods: for the Poisson vs negative binomial comparison I used a bounded LR test (Gutierrez et al., 2001) and for the negative binomial vs zero-inflated I used the Vuong (1989) test.

Regression coefficients calculated by count models are difficult to interpret in a meaningful way (Long and Freese, 2001). Hence, I transformed the coefficients to the expected percentage change in counts due to a unit change in the regressor (age), and to the expected percentage change due to a standard deviation change in the regressor. The usual post-fitting and residual checking techniques were applied to all models.

V.3.9 Personality

In order to obtain an index of individual “personality” and tendency to use vocalizations (versus other behavioural modules), I calculated scores from the reaction of each male to a standard stimulus, *i.e.*, an approaching human. Elephant seal males, when approached by human beings, show the same pattern of stereotyped behaviours that they show when approached by another male seal. To achieve standardization, the same person acted as stimulus during all trials. Trials were carried out during four breeding seasons, 1999 to

2002. I scored a total of 165 males for one or more seasons, and a total of 249 males/years (average of 8.6 ± 7.1 trials per male/year). A total of 178 males/years had more than 3 trials, and 102 males were scored for at least two years.

During each trial, I recorded the behavioural reaction of the male by taking note of the behavioural modules shown and their intensity. From these records, I extracted two kinds of measurements. A qualitative judgment of the male reaction, summarized as males that mainly tend to vocalize (= vocal), to attack (= aggressor), to use attack and vocalization equally (= mixed), to get distressed, showing a conflicted behaviour between displaying and leaving (= distressed), and to flee (= runaway). A quantitative measurement of male “aggressiveness” (= tendency to be aggressive, *sensu* Maynard Smith and Harper, 1988), was obtained by converting into scores, the behavioural modules showed during the stimulation trials. The scores ranged from -3 to 8, with a score of 0 for no reaction, positive increasing scores for visual display, vocalization, movement and aggression, and negative decreasing scores for distress, step back, submission and fleeing. I then calculated for each male the average score for each trial, and a seasonal grand mean, that was used as aggressiveness index.

V.3.10 Statistics

I present statistics as mean \pm standard deviation and least squares estimates as estimate \pm standard error (se). I visually inspected distribution of variables using boxplots and I tested normality using the Shapiro-Wilk test. I tested the homogeneity of means between the two years of study using the t-test with randomization, and the homogeneity of variances using the Brown-Forsythe test, again with randomization. Some variables presented a non-normal, clearly asymmetric distribution and, therefore, for these

variables, I calculated standard errors and confidence limits of parameters using a jackknife delete-one procedure (Mitchell-Olds and Shaw, 1987), and I carried out significance tests using randomization (Manly, 1997). The number of re-samplings used in randomization tests is stated as a subscript of the “P” label; the observed value of the statistic was included in the re-sampled statistics (Manly, 1997). In case of multiple non-independent test I calculated adjusted probabilities using a sequential Bonferroni procedure (Hochberg and Benjamini, 1990). Data exploration, calculation of measurement error and repeatability, linear regression, random effect model fitting, count regression model fitting, and randomization tests were carried out using STATA software (version 9, Stata Corporation Inc., www.stata.com).

V.4 RESULTS

V.4.1 Measurement error, repeatability and seasonal changes of acoustic features

The percentage measurement error for begin and end time of bouts was 1%. Mean repeatability of the different parameters in the full dataset was 0.513 ± 0.155 , ranging from 0.210 to 0.861 for the various acoustic features. Only 21% of the repeatabilities were below 0.400 and 8% below 0.300. The higher repeatabilities were found for the structural features and the bout duration. Repeatability of many acoustic features increased with age (Figure V.3). Visual inspection of scatter plot with fitted LOWESS smoother of acoustic features versus the day of the breeding season did not reveal any seasonal trend. The absence of linear trends was confirmed by linear regression analysis ($H_0: b = 0, p > 0.05$ in all cases).

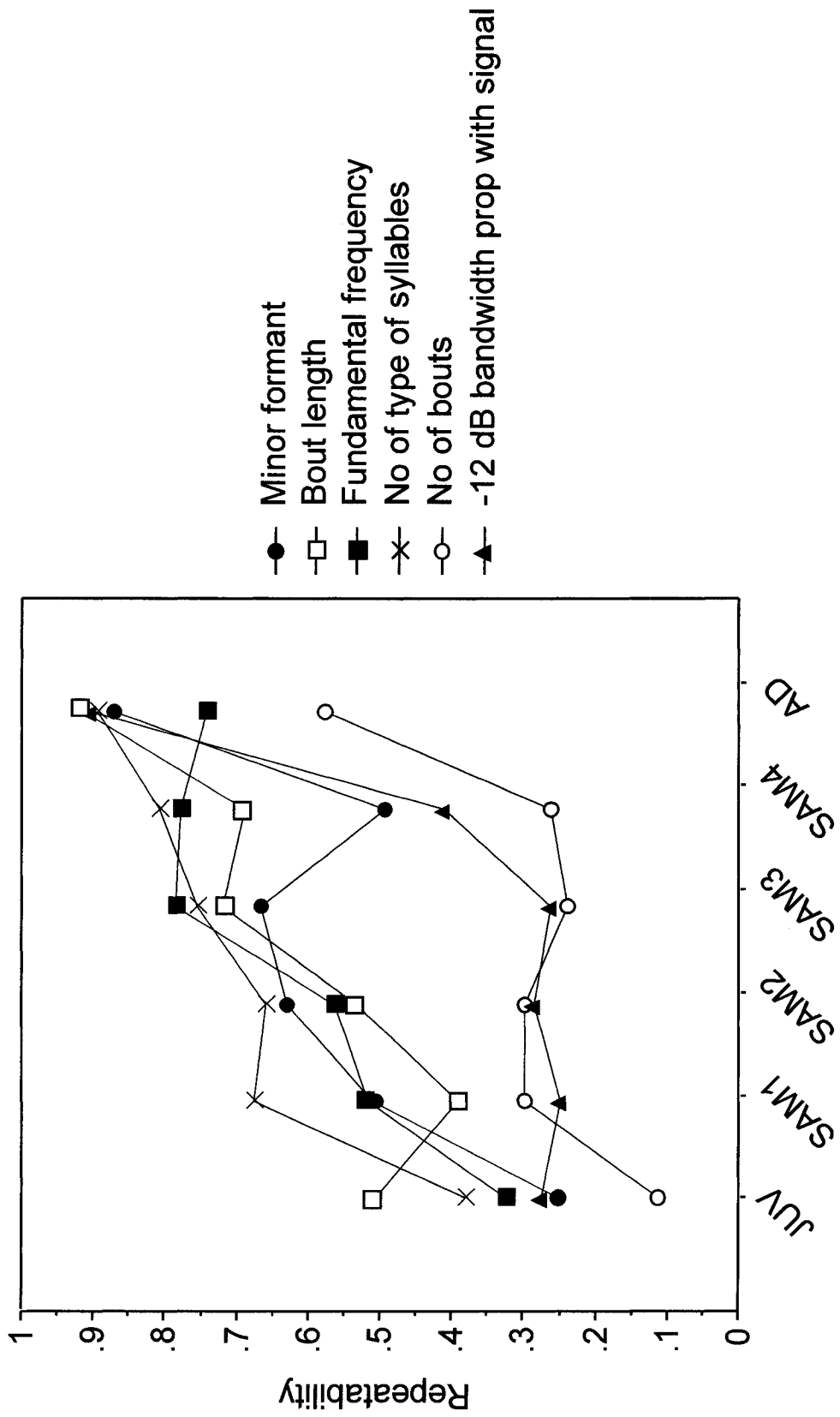

Figure V.3- Variation with age of the repeatability of some acoustic features of the vocalizations. Repeatability calculated from variance components (see Methods) using males of each class with at least five (seasonal) measures of the acoustic feature

V.4.2 Age specific variation of acoustic features

In a preliminary comparison of vocalizations between young (up to 8 years old) and old (9 years old and older) males, I found statistically significant differences in many acoustic features, including temporal, structural, frequency and intensity ones (Table V.1). Temporal and structural variables were bigger and most frequency variables were lower for old males.

I then carried out a more detailed analysis considering true age. Only a few of the acoustic features analyzed showed a clear age-specific variation (see Tables V.2 and V.3 for a summary of the age specific statistics for all variables measured). The visual inspection of scatterplots of acoustic features over age showed an ontogenetic trend for only a few of them. The dispersion within each age class was very high, making it difficult to detect a pattern of change with age. In order to take into account the longitudinal structure of my data, I ran a preliminary random effect regression model analysis for all the acoustic features, including the male identity as random effect. Formant frequencies were the only features showing a clear ontogenetic trend with age, decreasing from younger towards older age (Table V.4; Figure V.4).

Apart from these frequency characteristics, a few other temporal and structural features showed a weak trend of change with age, in particular the whole vocalization length and the number of types of syllables per bout, which increased with age, but the dispersion of the data was very high and percentage of variance explained by the models was rather small. In all cases but the minor formant a Breush-Pagan test showed that the variance component due to the random (within individual) effect was significant (at $P < 0.05$ level; Table V.4).

Table V.1 - Comparison of young and old males acoustic parameters. In the table I present only the parameters that are statistically different in the two groups. P_{10k} = probability of the randomization test (10000 replicates). Statistics are mean \pm standard deviation. * = significant at alpha = 0.05 (sequential Bonferroni correction, Holm method).

Acoustic parameter	n_Y	n_O	Young	Old	Diff	P_{10k}
Fundamental frequency (Hz)	233	132	29.7 \pm 14.0	27.1 \pm 7.8	2.5	0.0442
Max frequency at -12 dB (Hz)	234	132	793 \pm 421	880 \pm 366	-87	0.0466
12 dB bandwidth (Hz)	234	132	687 \pm 442	780 \pm 383	-93	0.0415
3 dB bandwidth proportion	234	132	0.91 \pm 0.14	0.88 \pm 0.13	0.03	0.0236
6 dB bandwidth proportion	234	132	0.88 \pm 0.14	0.85 \pm 0.13	0.03	0.0343
F1 (Hz)	220	130	273 \pm 40	259 \pm 28	15	0.0003*
F2 (Hz)	220	130	619 \pm 130	549 \pm 83	70	0.0001*
F3 (Hz)	220	129	962 \pm 187	799 \pm 118	163	0.0001*
F4 (Hz)	220	130	1298 \pm 271	1067 \pm 146	230	0.0001*
F5 (Hz)	219	130	1619 \pm 308	1341 \pm 195	278	0.0001*
Formant dispersion (Hz)	220	130	336 \pm 73	271 \pm 48	65	0.0001*
Minor formant (Hz)	204	111	87 \pm 26	77 \pm 17	11	0.0001*
No of bouts per vocalization	246	156	1.9 \pm 1.0	2.3 \pm 1.1	-0.4	0.0001*
Vocalization length (sec)	246	156	8.22 \pm 4.78	10.43 \pm 6.03	-2.21	0.0000*
Relative peak time	246	156	0.569 \pm 0.164	0.616 \pm 0.149	-0.050	0.0038
Peak intensity predominance	246	156	0.821 \pm 0.029	0.832 \pm 0.041	-0.010	0.0013*
Spectrum max/4000 Hz slope	234	132	-0.006 \pm 0.001	-0.007 \pm 0.001	0.00032	0.0110
Spectrum max/-24 dB slope	234	132	-0.036 \pm 0.027	-0.030 \pm 0.021	-0.00600	0.0289
No of syllable per bout	233	132	5.75 \pm 3.00	6.44 \pm 3.34	-0.69	0.0460
No types of syllables per bout	233	132	2.17 \pm 0.64	2.41 \pm 0.67	-0.23	0.0008*

Table V.2 - Average values of frequency domain parameters for different age classes. Sample size in brackets below the column headings.

Acoustic parameter	JUV (18)	SAM1 (55)	SAM2 (95)	SAM3 (78)	SAM4 (60)	AD (96)
Dominant frequency (Hz)	375	342	297	301	310	321
Fundamental frequency (Hz)	31.2	30.3	29.4	29.1	28.0	26.6
Peak frequency (Hz)	402	387	308	329	319	349
3 dB bandwidth (Hz)	187	192	134	196	168	211
6 dB bandwidth (Hz)	331	354	252	340	305	385
12 dB bandwidth (Hz)	766	797	560	733	756	796
18 dB bandwidth (Hz)	1362	1342	1059	1345	1373	1357
Min frequency at -3 dB (Hz)	292	236	229	223	236	235
Min frequency at -6 dB (Hz)	243	187	187	180	189	183
Min frequency at -12 dB (Hz)	146	99	107	99	102	98
Min frequency at -18 dB (Hz)	70	42	50	49	46	43
Max frequency at -3 dB (Hz)	478	427	363	419	404	446
Max frequency at -6 dB (Hz)	574	541	439	520	495	568
Max frequency at -12 dB (Hz)	912	897	667	833	858	894
Max frequency at -18 dB (Hz)	1433	1384	1109	1394	1419	1400
3 dB bandwidth proportion	0.95	0.90	0.94	0.87	0.90	0.86
6 dB bandwidth proportion	0.92	0.86	0.91	0.85	0.87	0.83
12 dB bandwidth proportion	0.85	0.82	0.87	0.86	0.83	0.86
18 dB bandwidth proportion	0.86	0.88	0.85	0.84	0.85	0.88
F1 (Hz)	322	289	266	259	259	258
F2 (Hz)	759	668	600	575	554	546
F3 (Hz)	1168	1050	945	872	810	792
F4 (Hz)	1667	1431	1264	1159	1086	1055
F5 (Hz)	2086	1757	1593	1444	1364	1326
Formant dispersion (Hz)	441	367	332	297	276	268
Minor formant (Hz)	106	88	85	85	78	76

Table V.3 - Average values of temporal, intensity and structural parameters for different age classes. Sample sizes in brackets below the column headings.

Acoustic parameter	JUV (18)	SAM1 (55)	SAM2 (95)	SAM3 (78)	SAM4 (60)	AD (96)
No of bouts per vocalization	1.4	1.6	1.9	2.2	2.1	2.4
Bout length (sec)	3.39	3.64	3.57	3.84	3.69	3.48
Interval between bouts (sec)	2.20	2.15	2.11	2.21	2.16	2.04
Vocalization length (sec)	5.29	6.96	8.20	9.81	9.45	11.04
Ratio signal/total length	0.671	0.727	0.724	0.726	0.732	0.730
Relative peak time	0.513	0.543	0.567	0.601	0.582	0.637
Max syllable part length (sec)	0.63	0.50	0.51	0.60	0.51	0.61
Inst. relative peak intensity	0.75	0.75	0.76	0.76	0.76	0.75
Peak intensity predominance	0.82	0.81	0.83	0.82	0.83	0.84
Spectrum total slope	-0.00184	-0.00193	-0.00185	-0.00189	-0.00192	-0.00192
Spectrum 0/4000 Hz slope	-0.00658	-0.00635	-0.00678	-0.00649	-0.00663	-0.00686
Spectrum ascending slope	0.06174	0.06183	0.07511	0.07454	0.07005	0.06752
Spectrum max/4000 Hz slope	-0.00668	-0.00612	-0.00637	-0.00628	-0.00645	-0.00674
Spectrum max/-24 dB slope	-0.03817	-0.03216	-0.03810	-0.03435	-0.03053	-0.02882
No of syllable per bout	5.12	5.44	5.98	5.87	6.35	6.50
Syllable rate	1.76	1.68	1.78	1.74	1.91	1.95
No of types of syllables per bout	1.90	2.07	2.20	2.28	2.37	2.43
Shannon index	0.817	0.814	0.816	0.822	0.801	0.776

Table V.4 - Random regression model analysis of some acoustic parameters (the only ones for which a trend was apparent) with age. R^2 = coefficient of determination; a and b = model parameters (intercept and slope); $se(b)$ = standard error of the regression coefficient calculated with a jackknife delete-one procedure; 95% CL(b) = 95% confidence limits of the regression coefficient; P_{10k} = significance of the regression coefficient calculated with randomization; P = probability of the Breusch-Pagan test on the significance of the random effect (*i.e.*, the male identities). * = significant at $\alpha = 0.05$ (sequential Bonferroni correction, Holm method).

Acoustic parameter	R^2	a	b	$se(b)$	95%CI(b)	P_{10k}	P
F1	0.0857	321.751	-6.633	1.12249	-9.804,-5.388	0.0001*	0.0000
F2	0.1320	805.589	-25.719	3.50418	-35.042,-21.258	0.0001*	0.0000
F3	0.2543	1314.608	-49.657	4.86313	-62.534,-43.405	0.0001*	0.0000
F4	0.2774	1828.181	-74.142	7.88737	-95.003,-63.977	0.0001*	0.0000
F5	0.2925	2278.525	-92.987	9.45475	-121.042,-83.851	0.0001*	0.0000
Formant dispersion	0.2775	489.097	-21.567	2.19934	-27.994,-19.343	0.0001*	0.0000
Minor formant	0.0672	108.177	-2.997	0.60713	-4.170,-1.780	0.0001*	0.1877
Fundamental frequency	0.0131	35.100	-0.755	0.31716	-1.503,-0.256	0.0250*	0.0002
No of bouts per vocalization	0.0564	0.925	0.132	0.02492	0.093,0.191	0.0001*	0.0000
Vocalization length	0.0733	2.126	0.825	0.13668	0.688,1.226	0.0001*	0.0000
Relative peak time	0.0382	0.477	0.013	0.00452	0.002,0.019	0.0001*	0.0237
No of types of syllables per bout	0.0596	1.529	0.088	0.01836	0.057,0.129	0.0001*	0.0000

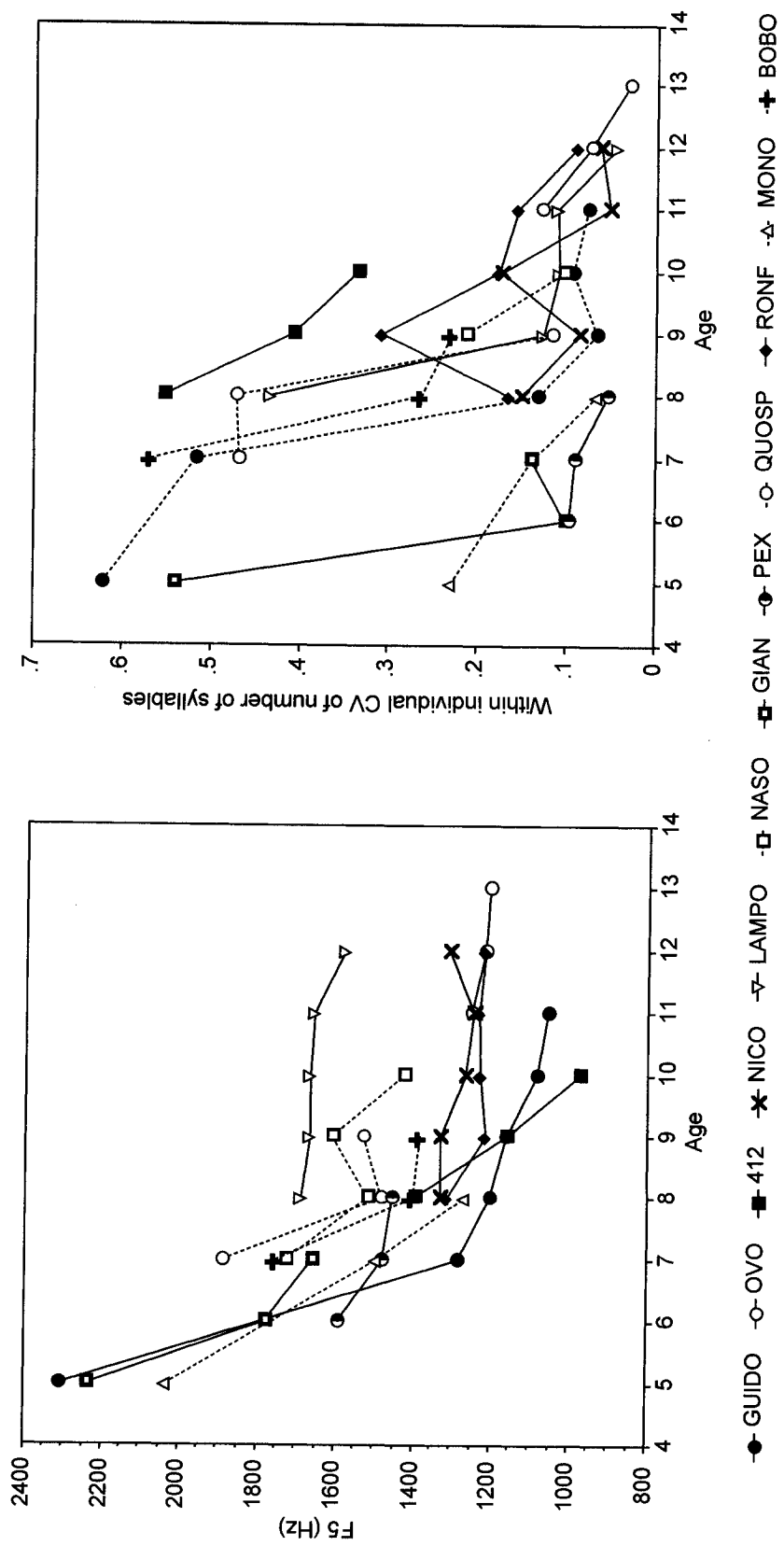

Figure V.4 - Individual variation of acoustic parameters. A) Age specific variation of the mean of the fifth formant in a sample of males recorded for three or more breeding seasons; B) Age specific variation of the relative variability in the number of syllables for the same males.

All formant frequencies appeared to decrease with increase in age, but the trend was more evident, and the relationship with age stronger, for the upper formants and for dispersion of formants. The examination of LOWESS smoother applied to the data suggested the presence of a threshold effect in the relationship between the different formants and age. All formants frequencies and the formant dispersion decreased almost linearly until approximately age 7-9, from where they either stopped decreasing, or showed a greatly reduced decrease rate. Therefore, I fitted piecewise regressions with unknown bending point (see Methods). For all the formants I obtained a better fit with the piecewise model than with the simple linear model (as from AIC difference), with the regression lines after the bending point less steep, and its regression coefficient always significantly different than before (Table V.5; Figure V.5).

The examination of residuals confirmed the better fit of the piecewise models. For the linear models, residuals were not homogeneous along the age axis, with a curvilinear shape, excess positive residuals for extreme ages and excess negative ones for middle ages. On the contrary, residuals from the piecewise regressions were homogeneously distributed around zero. To check the effect of the longitudinal component of the data, I ran random regression models before and after the bending point, finding that the slopes were not significantly different from the ones calculated for the linear piecewise model (in which I were unable to control for longitudinal effect). The percentages of variance in the formant frequencies explained by age were higher for upper formants: 8.6% for the minor formant, going from 18.4% for the first formant up to 40% for the fifth one, and 37.2% for formant dispersion (Table V.5).

Table V.5 - Piecewise linear models (see Methods) of formant frequencies versus age. The t test regards the hypothesis $H_0: b_{\text{dif}} = 0$, i.e., the significance of the change in slope after the bending point BP. R^2 = coefficient of determination; 95% CI = confidence interval; P = significance of the regression coefficient. * = significant at $\alpha = 0.05$ (sequential Bonferroni correction, Holm method).

Acoustic parameter	R^2	BP	a_0	95% CI(a_0)	b_1	95% CI(b_1)	b_{dif}	95% CI(b_{dif})	b_2	t	P
Minor formant	0.0860	6.00	195.8	126.96,264.62	-18.04	-20.19,-15.89	15.66	13.13,18.19	-2.39	12.175	0.0001*
F1	0.1840	7.23	450.9	399.3,502.5	-26.50	-34.47,-18.53	26.20	17.75,34.64	-0.31	6.102	0.0001*
F2	0.2010	7.33	1126.7	961.8,1291.7	-75.51	-100.98,-50.04	68.62	41.64,95.60	-6.89	5.002	0.0001*
F3	0.3300	8.52	1616.7	1465.2,1768.3	-94.26	-115.88,-72.64	86.45	58.92,113.99	-7.81	6.176	0.0001*
F4	0.3800	7.60	2588.1	2274.4,2901.8	-189.92	-238.37,-141.47	166.10	114.76,217.43	-23.83	6.364	0.0001*
F5	0.4000	8.30	2908.4	2670.1,3146.6	-185.71	-219.71,-151.71	172.69	129.44,215.93	-13.02	7.854	0.0001*
Formant dispersion	0.3720	8.37	626.4	568.3,684.5	-41.73	-50.02,-33.45	38.58	28.03,49.13	-3.15	7.193	0.0001*

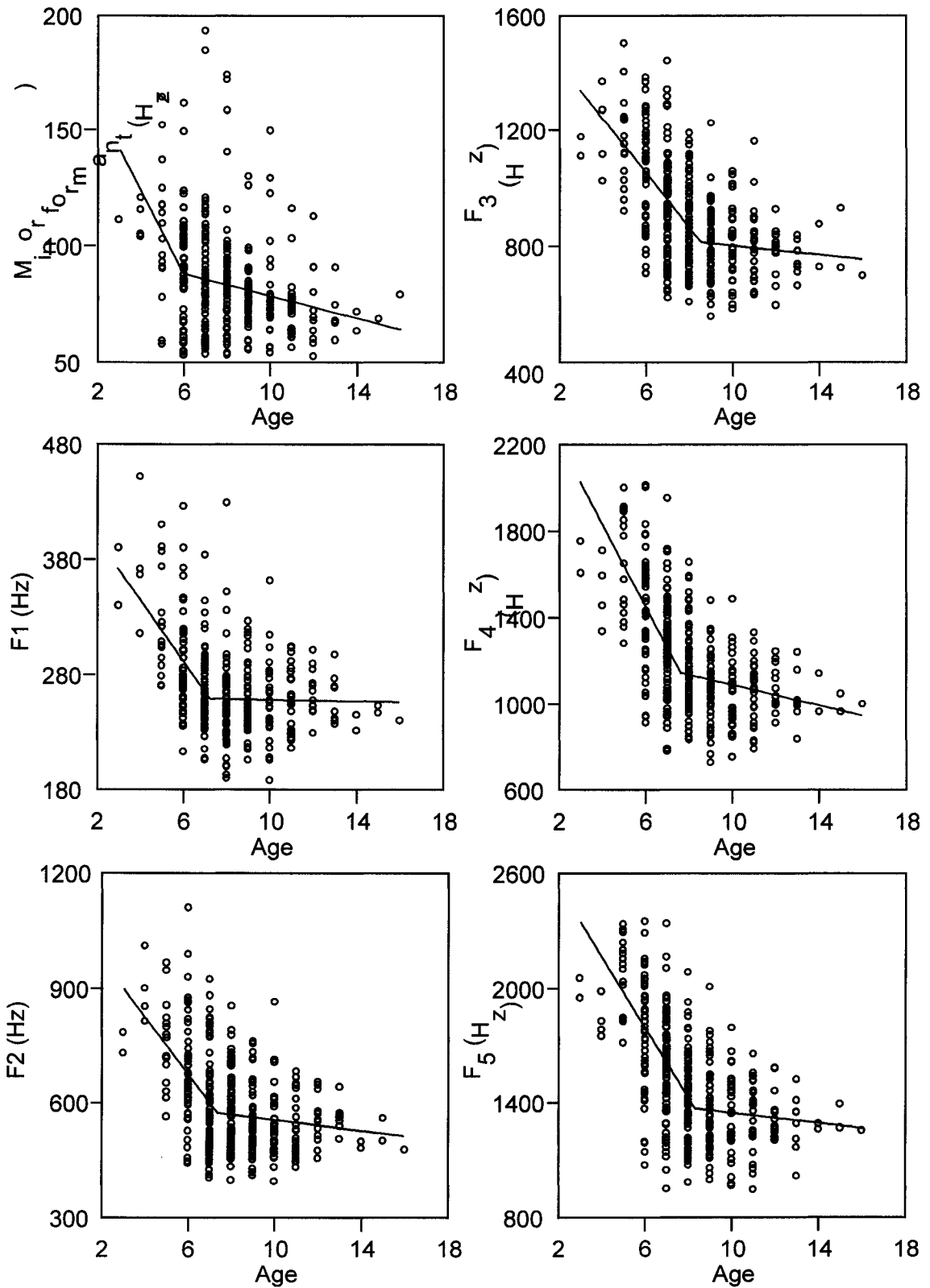

Figure V.5 - Age specific change in formant frequencies. The figure shows piecewise regression lines fitted using a four parameter, unknown change point model fitted by non-linear least squares (see Methods). Points are individual males (some represented for more than one breeding season). All measurement in Hz.

V.4.3 Age related change in within-individual variability

I already showed (Chapter 4) that vocalizations tend to become more stereotyped in their macrostructure with age. Older animals present much more structured vocalizations than younger ones, which often show non-structured, extremely variable vocalizations. In order to test if this is true also for specific acoustic features of the sounds, I measured the within individual variability of each acoustic feature, and I compared these measures among different age classes. As a relative variability measure I calculated the coefficient of variation (CV) of each parameter for each male, based on its measured vocalizations (5 per males).

I firstly compared young versus old animals. I found statistically significant differences (t test with randomization, $p_{10K} < 0.05$ in all cases, sequential Bonferroni correction) in within male CV for all the macrostructure features (number of syllables, syllable rate, number of types of syllables and Shannon index), for many temporal features (bout length, interval between bouts length, relative peak time and max syllable part), and for only three of the frequency features (fundamental frequency; -3dB bandwidth and 3 bandwidth proportion). None of the formant frequencies showed a significant difference in within male CV between young and old animals. In all cases, but the -3dB bandwidth and 3 bandwidth proportion, within male variation was higher for young animals than for older ones (Figure V.6).

In order to take into account the longitudinal component of my dataset, I then used a random regression model of individual CVs on age, with male identities as random effect. The mean individual CVs apparently decreased with age for different variables, in particular for some temporal and structural ones (Table V.6; Figure V.4), but their

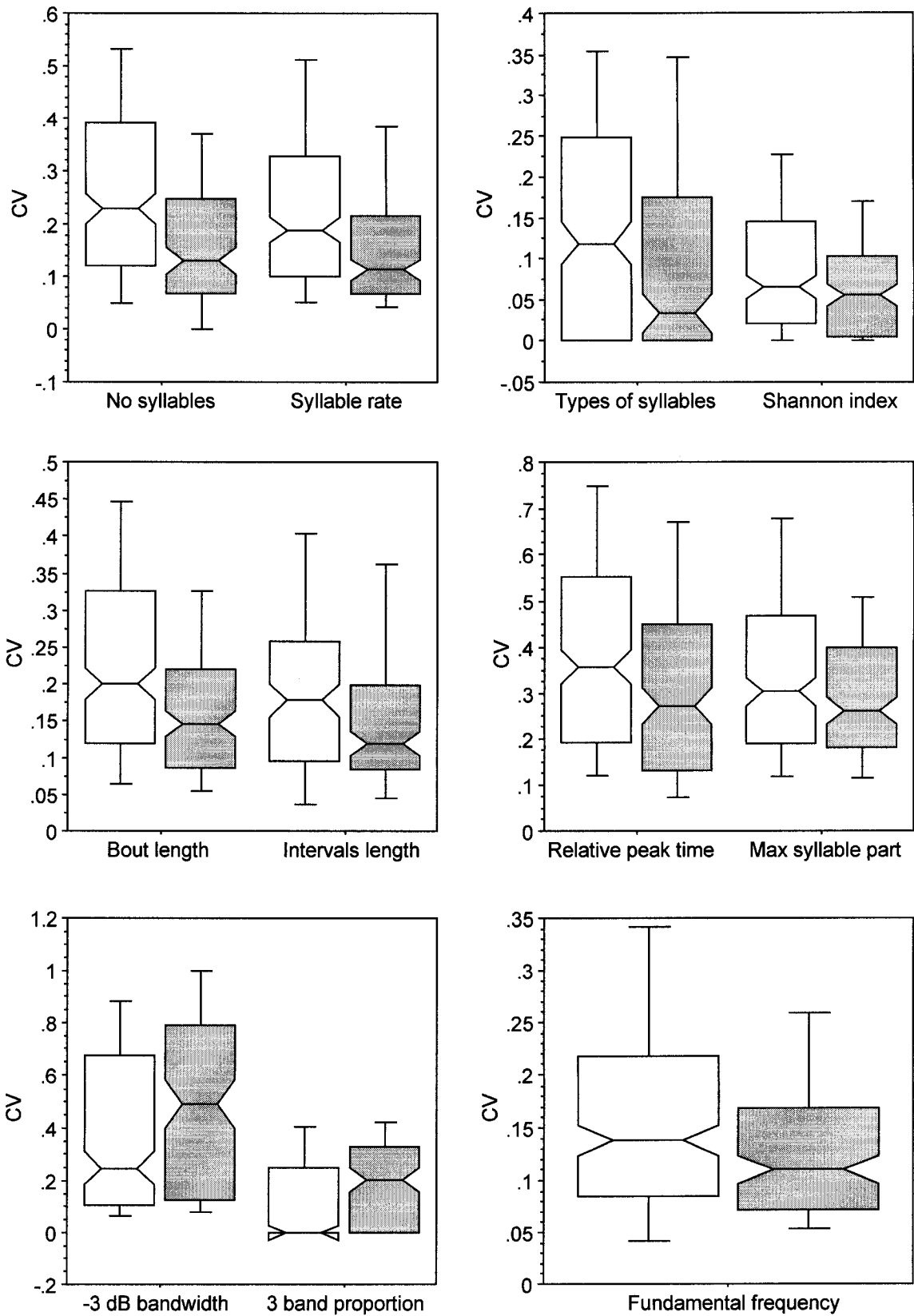

Figure V.6 - Boxplots of within-individual acoustic variation of some acoustic parameters in young and old animals. White boxes for young males and grey for old ones

Table V.6 - Mean within male CVs for different age classes. I included only the acoustic variables for which it was possible to detect a trend of mean CVs with age: all variables, except number of bouts, present decreasing trends. Sample sizes in brackets below the column headings. P_{10k} = significance of a regression coefficient calculated with randomization, of a mixed linear model ran using individual CV of the acoustic variables as dependent variable and age as independent ; * = significant at alpha = 0.05 (sequential Bonferroni correction, Holm method).

Acoustic parameter	JUV (18)	SAM1 (55)	SAM2 (94)	SAM3 (78)	SAM4 (60)	AD (96)	CV Trend	P_{10k}
Bout length	0.252	0.249	0.237	0.216	0.199	0.148	decreasing	0.0001*
No of bouts per vocalization	0.243	0.374	0.389	0.447	0.457	0.429	increasing	0.0257
Interval between bouts length	0.251	0.227	0.182	0.197	0.205	0.135	decreasing	0.0019*
Relative peak time	0.459	0.477	0.426	0.329	0.418	0.274	decreasing	0.0002*
Syllable part with max peak pressure length	0.380	0.369	0.361	0.336	0.332	0.286	decreasing	0.0164
No of syllables per bout	0.455	0.301	0.268	0.223	0.208	0.160	decreasing	0.0001*
Syllable rate	0.363	0.271	0.250	0.197	0.216	0.150	decreasing	0.0001*
No of types of syllables per bout	0.233	0.154	0.142	0.116	0.107	0.102	decreasing	0.0001*
Shannon index	0.183	0.105	0.093	0.068	0.069	0.071	decreasing	0.0002*
Spectrum max amplitude/4000 Hz slope	-0.159	-0.160	-0.160	-0.153	-0.151	-0.132	decreasing	0.0278
Fundamental frequency	0.176	0.198	0.167	0.152	0.137	0.135	decreasing	0.0030*

dispersion was very high within each age class, hence the random regression models, although indicating a significant trend in the expected direction, gave a poor fit.

On the whole dataset, temporal and structural parameters showed the highest average within-male CVs, in particular for measures of the whole vocalization (vocalization length and number of bouts, respectively with 0.555 and 0.413), bout duration (0.207) and syllable structure features (0.220 for syllable rate and 0.238 for number of syllables per bout). On the contrary, intensity and frequency features showed the lower within individual variations (0.016 for the peak intensity predominance and 0.024 for the relative peak intensity; 0.069 for F1; 0.150 for dominant frequency and 0.157 for fundamental frequency).

V.4.4 Age related change in among- individual variability

I compared the total among-males variation of the acoustic features between young and old animals. Various features showed statistically significant differences in among-individual CV in the two groups (Table V.7). In all cases, except the spectral slopes and the intensity distribution, variability of acoustic features was higher in young than in old males. In particular, all formant frequencies and three of the parameters related to the -6, -12 and -18 dB bandwidth, showed higher variation among young than among old animals (test t with permutation, following (Sokal and Braumann, 1980), $P_{10K} < 0.05$, sequential Bonferroni correction). Only one temporal feature, the relative peak intensity, showed a difference in variation between young and old, while none of the simple temporal features, such as bout and vocalization length, nor any of the structural features (related to syllable structure) showed a different level of variation between the two age groups.

Table V.7 - Among-male variation in acoustic features of young and old males. Statistics are mean \pm standard deviation of the coefficient of variations calculated for each male. P_{10k} = probability of a randomization test on the difference between the mean CVs, following Sokal and Braumann 1980; * = significant at alpha = 0.05 (sequential Bonferroni correction, Holm method).

Acoustic parameter	n_Y	n_O	Young	Old	Diff	P_{10k}
Min frequency at -6 dB	234	132	0.372 \pm 0.027	0.281 \pm 0.019	0.091	0.0426
Min frequency at -12 dB	234	132	0.561 \pm 0.046	0.438 \pm 0.033	0.123	0.0041*
18 dB bandwidth proportion	234	132	0.124 \pm 0.008	0.095 \pm 0.006	0.029	0.0116
F1	220	130	0.146 \pm 0.01	0.110 \pm 0.007	0.037	0.0375
F2	220	130	0.200 \pm 0.014	0.152 \pm 0.01	0.048	0.005
F3	220	130	0.188 \pm 0.013	0.149 \pm 0.01	0.039	0.0251
F4	220	130	0.202 \pm 0.014	0.140 \pm 0.01	0.063	0.0018*
F5	220	130	0.178 \pm 0.012	0.145 \pm 0.01	0.033	0.0391
Minor formant	204	111	0.322 \pm 0.027	0.230 \pm 0.019	0.092	0.0499
Spectrum 0/4000 Hz slope	234	132	-0.185 \pm 0.012	-0.136 \pm 0.009	-0.048	0.0068
Spectrum max/4000 Hz slope	234	132	-0.193 \pm 0.013	-0.159 \pm 0.01	-0.035	0.0485
Relative peak time	246	156	0.299 \pm 0.018	0.242 \pm 0.015	0.057	0.0264
Peak intensity predominance	246	156	0.039 \pm 0.002	0.049 \pm 0.003	-0.01	0.0392

V.4.5 Ontogeny of vocal behaviour

Behavioural data were available for 183 individually recognized males, present during 1 to 6 breeding seasons (for a total 334 males/seasons, and a mean of 1.83 seasons per males), spanning a range of ages from 6 to 14. Most measures of general agonistic and vocal behaviour showed a rather clear ontogenetic trend (Table V.8; Figure V.7), usually increasing with age.

For most variables the regression model that best fitted the data was the negative binomial (Table V.9) confirming the presence of over-dispersion. For four variables, including the number of bi-directional interactions, the number of interactions in which both males use vocalizations, the number of interactions in which the reactor replies to a vocalizing actor with a vocalization, and the number of interactions in which the reactor vocalizes at all, the Poisson regression gave a better fit than the negative binomial; but only for the first of these variables, the Poisson model including age fitted the data well (with a small decrease trend, percent change per one year change in age = -8.0%), while for the other three variables no effect of age was detected. The remaining variables were well fitted by a negative binomial model, and the model including age produced a significant improvement of the fit with respect to the null (intercept only) model (all LR test $p < 0.0001$; Table V.9). An increasing trend with age was observed for the following components of the social and vocal behaviour: the number of interactions in which the male is the actor (percent change per one year change in age = 49.6%); the number of interactions won (52.3%); the number of interactions settled by ritualized displays (= without direct contact, chase or fight; 12.2%); the number of interactions settled by vocalization (13.6%); the number of interactions in which the male uses vocalization

Table V.8 - Age specific statistics for various behavioural measures of social interaction and vocalization. int. = interaction, seq. = behavioural sequence; VO = vocalization.

Age	6	7	8	9	10	11	12	13	14	All
Number of males	42	83	66	57	42	24	9	8	3	334
% of males	12.6	24.9	19.8	17.1	12.6	7.2	2.7	2.4	0.9	
Mean number of interactions	52.9	80.7	102.4	129.6	209.5	238.5	290.2	338.9	392.0	132.0
Mean % bi-directional int.	8.0	9.8	9.9	10.2	6.9	5.5	7.1	8.5	2.7	8.8
Mean % int. in which male = actor	14.3	20.7	34.7	47.5	60.8	75.7	94.1	89.1	98.1	40.5
Mean % int. won	11.7	19.2	33.8	47.9	60.8	75.0	93.8	88.6	97.4	39.7
Mean % int. settled by VO	32.6	37.8	44.9	43.3	47.6	46.8	47.3	45.5	53.4	42.0
Mean % int. settled by VO and won	2.1	4.4	14.0	19.6	28.1	34.1	44.2	42.9	51.3	16.1
Mean % int. settled by VO with VO only	1.4	6.7	15.0	20.1	26.5	29.2	32.1	34.0	47.9	15.8
Mean % int. with VO	5.7	14.2	25.2	35.8	50.1	62.0	62.1	74.0	82.4	30.3
Mean % int. with bi-directional VO	1.4	3.9	6.2	5.7	10.3	4.6	4.3	3.6	0.0	5.1
Mean % int. male = actor and with VO	4.6	11.6	20.1	29.0	43.0	58.2	58.7	69.8	80.9	25.9
Mean % int. male = reactor and with VO	1.1	2.6	5.2	6.8	7.1	3.9	3.4	4.2	1.5	4.4
Mean % int. male react to VO with VO	0.8	1.4	2.4	3.5	4.7	2.6	0.8	3.1	0.0	2.4
Mean number of VO per seq.	0.039	0.214	0.084	0.163	0.456	0.604	0.789	1.360	1.003	0.345
Mean number of VO as actor per seq.	0.010	0.203	0.072	0.147	0.428	0.574	0.786	1.340	0.994	0.325
Mean number of VO as reactor per seq.	0.029	0.010	0.013	0.016	0.028	0.030	0.002	0.020	0.010	0.020
Mean number of bouts per seq.	0.039	0.426	0.160	0.315	0.907	1.084	1.548	1.680	1.502	0.637
Mean number of bouts as actor per seq.	0.010	0.410	0.140	0.289	0.879	1.066	1.547	1.660	1.486	0.615
Mean number of bouts as reactor per seq.	0.029	0.017	0.020	0.025	0.028	0.018	0.002	0.020	0.017	0.022

Table V.9 - Comparison of count regression models applied to the behavioural measures of social interaction and vocalization, and parameters and test of the best fitting model. P = Poisson regression, NB = negative binomial regression, ZINB = zero-inflated negative binomial regression, AIC = Akaike information criterion, Model = model chosen using AIC difference; LR test = likelihood ratio test of the model including age versus the null (intercept only) model (df = 1), * = significant at alpha = 0.05 (sequential Bonferroni correction, Holm method), b = regression coefficient, se(b) = robust standard error of the regression coefficient (see Methods), 95% CI(b) = 95% confidence interval of the regression coefficient; % unit = percentage change in the variable due to a unit (one year) change in age; % SD = percentage change in the variable due to a one standard deviation change in age. int. = interaction, trans. = behavioural transition, VO = vocalization.

Variable	P vs NB	NB vs ZINB	Model	LR test	b	se(b)	95% CI(b)	% unit	% SD
Total number of interaction	27.161	no 0	NB	$\chi^2 = 37.6, P < 0.0001^*$	0.075	0.017	0.042, 0.108	7.8	14.4
Bi-directional interactions	1.773	0.014	P	$\chi^2 = 65.3, P < 0.0001^*$	-0.083	0.010	-0.104, -0.063	-8.0	-14.0
Male is actor	30.797	0.007	NB	$\chi^2 = 215.5, P < 0.0001^*$	0.403	0.027	0.349, 0.456	49.6	106.8
Male win	31.187	0.044	NB	$\chi^2 = 208.6, P < 0.0001^*$	0.421	0.027	0.346, 0.477	52.3	113.7
Interaction is ritualized	21.674	-0.008	NB	$\chi^2 = 34.5, P < 0.0001^*$	0.116	0.022	0.072, 0.159	12.2	23.2
Interaction settled by VO	22.053	0.000	NB	$\chi^2 = 35.4, P < 0.0001^*$	0.127	0.024	0.080, 0.175	13.6	25.8
Male vocalize	26.168	0.000	NB	$\chi^2 = 117.7, P < 0.0001^*$	0.502	0.053	0.398, 0.606	65.2	147.5
Vocalization is bi-directional	0.143	0.036	P	$\chi^2 = 3.0, P = 0.0858$	-0.060	0.046	-0.150, 0.031	-5.8	-10.2
Male replays with VO to VO	0.001	0.000	P	$\chi^2 = 2.1, P = 0.1505$	-0.071	0.054	-0.178, 0.035	-6.9	-12.1
Male act (initiate) with VO	26.475	0.001	NB	$\chi^2 = 117.0, P < 0.0001^*$	0.534	0.057	0.422, 0.645	70.5	172.1
Male react with VO	0.241	0.042	P	$\chi^2 = 2.9, P = 0.0878$	0.477	0.033	-0.017, 0.112	4.9	9.0
Number of VO in trans.	26.280	0.105	NB	$\chi^2 = 42.5, P < 0.0001^*$	0.862	0.127	0.613, 1.110	136.7	373.8
Num. of VO in trans. as actor	25.945	0.101	NB	$\chi^2 = 43.7, P < 0.0001^*$	0.900	0.139	0.629, 1.171	146.0	408.1
Number of bouts in VO	54.947	0.106	NB	$\chi^2 = 37.2, P < 0.0001^*$	0.912	0.147	0.623, 1.200	148.9	418.8
Num. of bouts in VO as actor	54.604	0.105	NB	$\chi^2 = 37.6, P < 0.0001^*$	0.948	0.165	0.625, 1.271	158.1	453.7

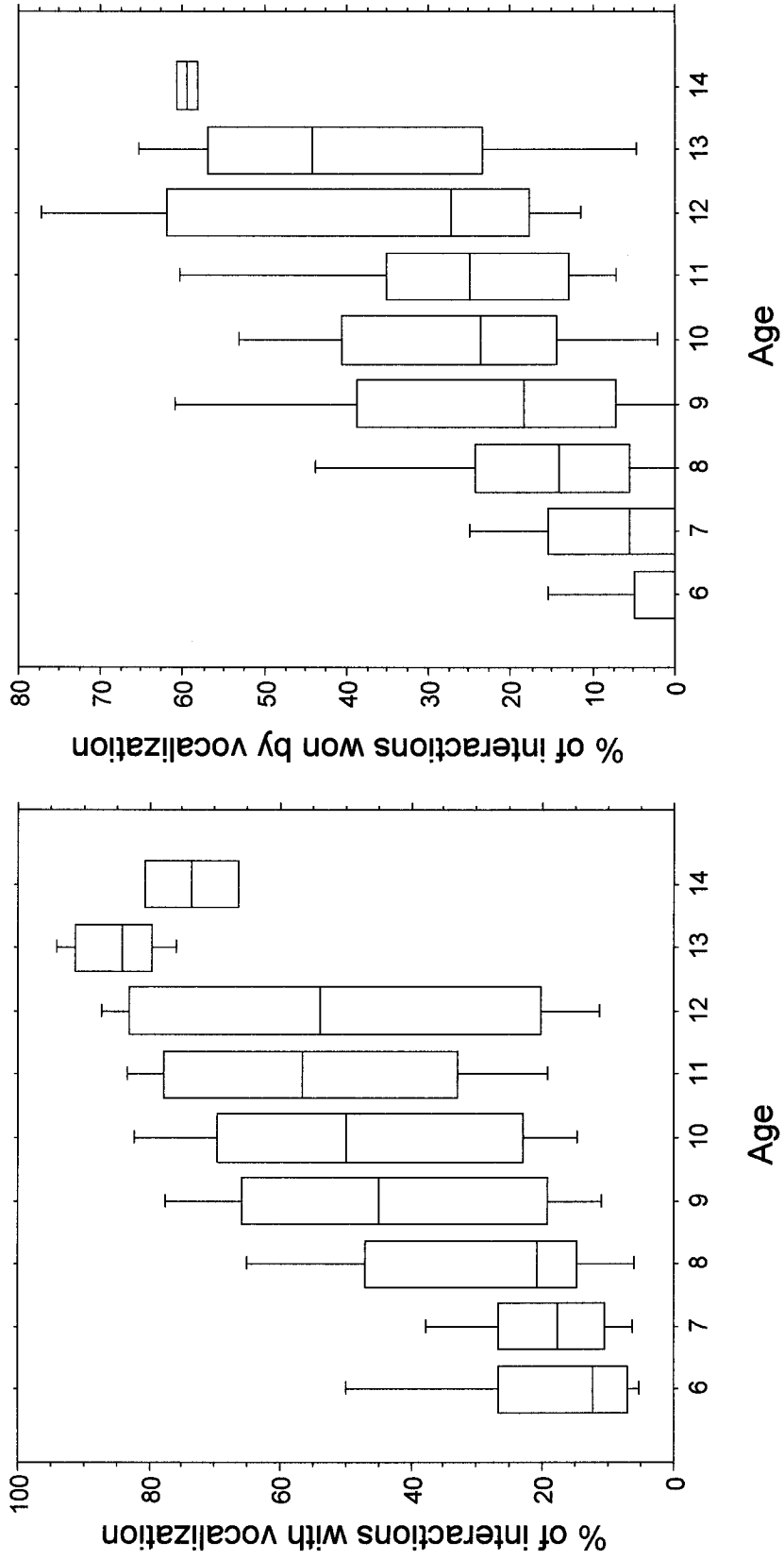

Figure V.7 - Boxplots of the age specific percentage of interactions in which the male emits one or more vocalization, and the percentage of interactions in which the vocalization actually let the male win the interaction.

(65.2%); the number of interactions in which the male uses vocalization to initiate the interaction (70.5%). To quantify the role of vocalization in the behavioural sequence of agonistic contests I calculated, for each sequence, the number of behavioural transitions involving a vocalization, and the number of bouts per vocalization. I found a strong positive increase with age in the following variables: the number of transitions involving vocalizations (136.7%); the number of behavioural transitions in which the male is the initiator and the behavioural module shown is the vocalization (146.0%); the number of bouts emitted (148.9%); the number of bouts emitted when the male is the initiator of the behavioural transition (158.1%).

V.4.6 Ontogenesis of personality

Mean repeatability of personality scores in the full dataset (from 1999 to 2002, 2143 measures) was 0.511 (95% CI = 0.44821-0.57459, $P_{10k} = 0.0001$), ranging from 0.400 to 0.745 depending on the year. Aggressiveness scores were not normally distributed (Shapiro-Wilk test, $W = 0.9625$, $p = 0.0001$), with three modes around scores -1, 1 and 4. The median value for the pooled dataset was 2.8 (MAD = 1.6), *i.e.*, a medium positive level of aggressiveness. The most frequent personality was the vocal (58.4% of the whole dataset), followed by the distressed (23.6%), and then the mixed, aggressor and runaway (respectively 10%, 4.8% and 3.2%).

Aggressiveness scores increased linearly with age, even though the proportion of variance in scores explained by age was rather low ($R^2 = 0.215$; $b = 0.616$; $se(b) = 0.068$; 95% CI = 0.481-0.751; $P_{10k} = 0.0001$), and the residuals from the linear model showed a large variation in aggressiveness among each age class. To examine the effect of the

longitudinal component of the database, I ran a random effect regression model, with male identity as random effect. The slope of this model was almost equal to the simple regression ($b = 0.703$; $se(b) = 0.078$; 95% CI = 0.556-0.864; $P_{10k} = 0.0001$). A Lagrange multiplier test showed that the variance component due to within individual effect was in any case significant ($\chi^2 = 6.70$, $df=1$, $P = 0.0096$).

Personality changed with age. Frequencies of personality types were not homogeneous among age classes (Chi-square test for independence, with randomization: $\chi^2 = 35.23$; $P_{10k} = 0.0219$; Figure V.8). The proportion of vocal, aggressor and mixed males increased with age, while proportions of distressed and runaway males decreased. The observed trends in proportions of all the different personalities, except aggressor, were statistically different from zero (Cochran-Armitage exact test: all exact $P < 0.02$), and in accordance with the expectation of an increasing level of vocal and aggressive behaviour with age. Only around 40% of juvenile males were vocal, while the proportion increased up to more than 64% for old subadult and adult males. On the other hand, more than 60% of juvenile males had distressed or runaway personality, while the percentage decreased to around 10% for adults and old subadults. The trend in proportion for the aggressor personality was in accordance with the prediction (increasing), but not statistically significant, possibly due to the small total sample size for this personality.

V.5 DISCUSSION

Male vocalizations are a crucial component of the agonistic behaviour of southern elephant seals, being present in most interactions between males for access to breeding

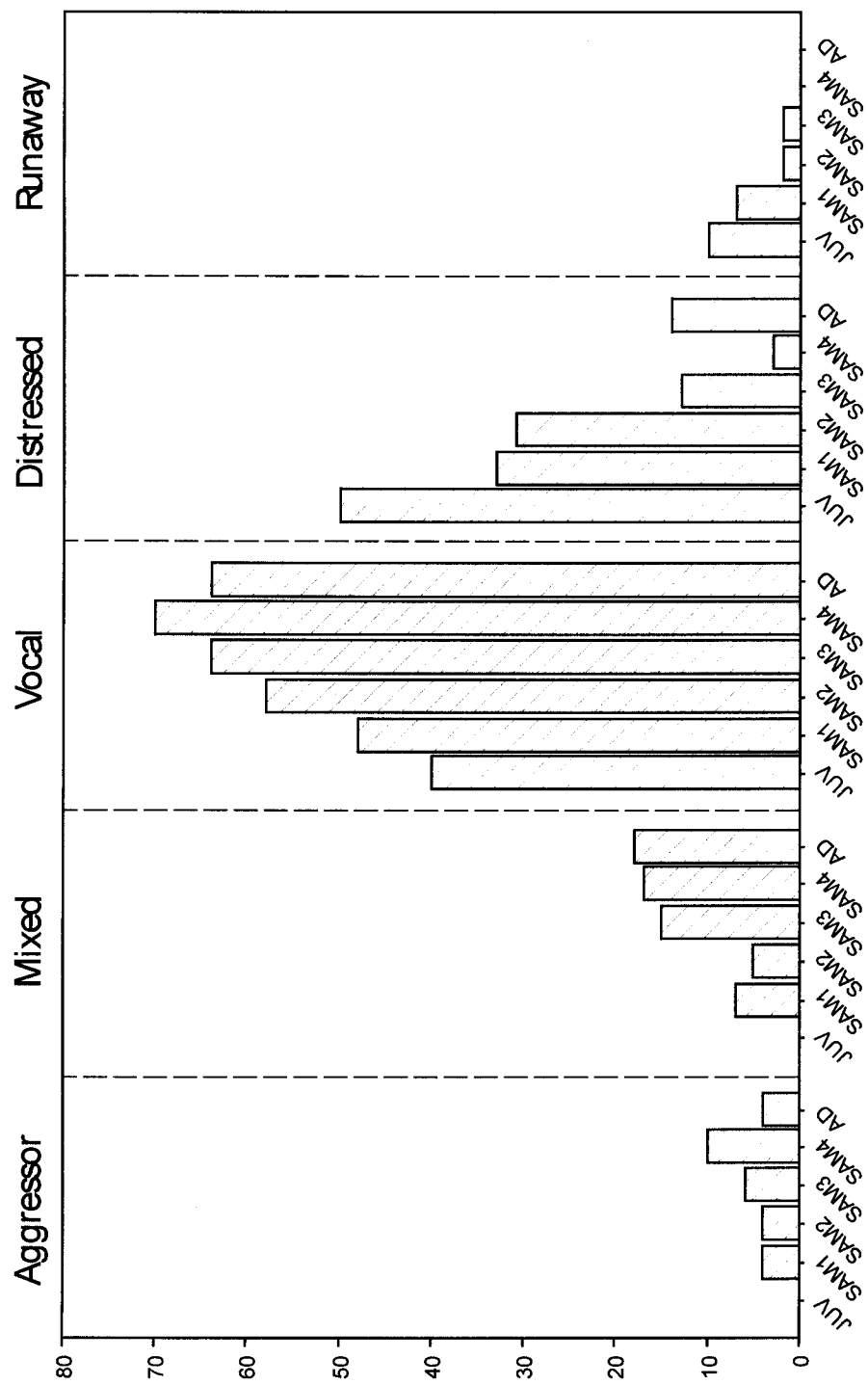

Figure V.8 - Bar charts of the variation among age categories of the percentage of males showing different personalities (see Methods for definition)

females (McCann, 1981; Sandegren, 1976; Chapter 4). SES males at Sea Lion Island showed a rather clear ontogenetic trend in the involvement in social interactions, in the use of ritualized forms of agonistic behaviour, in the use of vocalizations and in the effectiveness of its use in the resolution of agonistic contests. Competition between elephant seal males is intense and produces impressive results on the distribution of matings (Galimberti et al., 2002; Le Boeuf and Reiter, 1988). This competition has two costs, energetic and physical damage. The absolute energetic cost of competition of elephant seals is the highest observed in vertebrates (Deutsch, 1990; Galimberti et al., submitted), with some males losing up to 50% of their body weight during the breeding season. Male elephant seals fast for up to more than 100 days while on land for breeding. From an energetic point of view, the main cost of reproduction for elephant seal males, is maintenance, but the intensity of behavioural activity may affect the energetic expenditure of large animals adapted to an aquatic lifestyle. Although chases are rather frequent, and fights occasionally happens, a large proportion of agonistic interactions involve vocalizations, whose energetic cost is modest if compared to more direct forms of aggression. The cost due to wounds and physical damage is more difficult to assess (Geist, 1974). In elephant seal males, wounding due to fights is frequent (Braschi, 2004; Deutsch, 1990) but true lethal fights (Enquist and Leimar, 1990) seem to be very rare or absent (at Sea Lion Island just one lethal fight was observed on a ten year span, in which more than 1300 fights were observed). On the other side, even non-lethal wounds may largely affect the breeding success of males, reducing their capability to compete (*e.g.*, due to the effect of infections). The tendency towards the ritualization of agonistic

behaviour and the increase in the use and effectiveness of vocalizations can reduce these costs.

Various acoustic features of the agonistic vocalizations emitted by SES males showed an ontogenetic variation with age, in particular when the gross categories of young and adult males are compared. Similar results have been obtained in the northern species (Shiplely et al. 1986), although on a more limited data set, and a smaller number of acoustic features. On the other hand, just a few of these features showed a clear trend with actual age, and the dispersion around the trend was always rather large or even very large. Two components of the ontogeny of sounds should be evaluated: the change in the mean values of acoustic features, and the change in their relative variability, both within and among individuals. The interest in variability of behavioural patterns dates back to the very beginning of ethology (Barlow, 1977) and the coefficient of variation has been frequently used as a measure of “stereotypy” to quantify the decrease in variability during the ontogeny (Bekoff, 1977).

Vocal ontogeny can be the product of two main processes, the vocal learning of acoustic features (*i.e.*, the within-individual change in acoustic features of vocalizations due to auditory experiences), and the maturation process due to the change in the structural phenotype during growth that affects the structures used to produce the sounds (Egnor and Hauser, 2004; Fitch and Hauser, 2002). Vocal learning should be focused on acoustic features that are not strictly and directly constrained by structural phenotype, such as those able to develop independently from morphology and size, following the acoustic and social habitat in which the individual development happens. On the other

hand, the maturation process should be prevalent for acoustics features that depend on morphology and body growth.

The source-filter model of sound production, originally proposed and developed for human speech (Fant, 1960), was recently extended to all mammal vocalizations (Fitch, 1994; Fitch, 2000). Accordingly to this model, most mammal vocalizations are produced by the larynx (the periodic or quasi-periodic “source”) and then filtered by the vocal tract (the “filter”), before being emitted through the nostrils and lips. The rate of oscillation of the source is responsible for the "pitch" of the sound (= its fundamental frequency, F₀). The resonances of the vocal tract act as a filter on the original sound, selectively “amplifying” some frequencies by “damping” others, thus producing what are known as formant frequencies, *i.e.* frequencies in the amplitude spectrum of a sound that seem to be reinforced by the resonance of the vocal tract (Fitch, 1994; Fry, 1979; Miller and Murray, 1995). Overall, the formant frequencies and their spacing should decrease with increase in vocal tract length (Fitch, 1994; Fry, 1979), while the F₀ should decrease with increasing size and mass and decreasing tension of the vocal folds. The two processes are independent of each other (Fitch, 2000; Fry, 1979). While mammals seem able to change their vocal fold tension and length over a quite large range by the action of the laryngeal muscles (hence changing their F₀), their vocal tract length depends on the structural phenotype, being constrained by the bones of the skull (Fitch, 2000; Fitch and Hauser, 2002). Therefore, the formants, contrary to fundamental frequencies, should be more strictly dependent on the animal’s morphology. Temporal and structural features of the vocalizations, on the other hand, are almost free from physical constraint due to structural phenotype and, hence, can be the target of vocal learning (Chapter 4).

The maturation and learning processes should produce different ontogenetic changes of mean and variability of different acoustic structures. Therefore, hypotheses can be formulated about the age-specific variation of acoustic structures that may permit discrimination between them, as follows.

V.5.1 Variation of the mean value of acoustic features

The mean value of acoustic features that are constrained by the structural phenotype should present a trend of change with age, because of the change in body size and shape and, therefore, they should be mainly the result of a maturation process. In accordance with this hypothesis, the formants were the acoustic features showing the strongest ontogenetic trend of change with age, with a linear decrease up to age 7-8, and increasing strength of the trend for higher formants. Older males had lower frequency formants than younger males, although the relationship of formant frequencies with age was not homogeneous across the whole age span, as shown by the better fit obtained using piecewise regression models. Formants are rather strictly related to the structural phenotype of the male, because, accordingly to the source-filter model of sound production, they are determined and constrained by the size and shape of the vocal tract. On the other hand, the mean value of acoustic features that are not constrained by the structural phenotype should be free to change in any direction and, therefore, should show no clear ontogenetic variation, in particular if vocal learning leads to the adoption of individually distinct vocal features (Chapter 4). In accordance with this hypothesis, the temporal features and the syllable structure of the sounds showed no clear trend of change with age, and even the differences between young and old male were blurred. Moreover,

the frequency features that, in accordance with the source-filter model, are not related to the vocal tract length (*e.g.*, the fundamental frequency) showed no ontogenetic trend. In some species (*Papio cynocephalus*: Fischer et al. 2004) temporal components of the vocalizations show an ontogenetic trend that suggest that a constraint due to the structural phenotype is acting. In particular, the length and repetition rate of calls seems to increase with age. In these species the sound emission seems to be a significant cost for the males. On the contrary, in SES males, the cost of vocalizations is likely to be negligible if compared to the whole breeding effort (Deutsch, 1990; Galimberti et al., submitted) ,and the temporal aspects of vocalizations are not expected to be related to structural phenotype.

V.5.2 Within-male variation of the variability of acoustic features

The constrained acoustic features should show no ontogenetic trend of change, because these features are not free to change, depending on the structural phenotype and, therefore, should be almost steady within males at each age class. Due to such constraints, the level of stereotypy should be about the same at all ages. In accordance with this hypothesis, the relative variability of the formants, which are the most structurally constrained of all acoustic features, showed no change with age and no increase in stereotypy. On the contrary, the acoustic features that are not constrained by body size and are, in principle, targets of vocal learning, should show an increase level of stereotypy due to the learning process, by which each male increases his vocal competence. Most acoustic features related to the time domain and all features related to the syllable structure of the bouts showed a decrease with age in the within-male relative

variability (*i.e.*, an increase in stereotypy). Moreover, I expect the whole variability, pooled across ages, of the acoustic features that are constrained to be lower than the features that are not. In accordance with this hypothesis, the relative variability of frequency features was lower than the variability of structural and temporal features, in analogy to what has been found in other species (Insley, 1992; Miller, 1991).

V.5.3 Among-male variability of acoustic features

For structurally constrained features, I expect the among-male variability to mimic the variation in structural phenotype. Therefore, I expect to have a greater variability for these features among young males, that are growing and, therefore, show a greater variability in the distribution of phenotypes (Clinton 1994). The coefficient of variation of formants was, in fact, significantly greater in young than in old males. On the contrary, features that are not constrained by structural phenotype should show no systemic difference between young and old males. In accordance with this hypothesis, there was no significant difference between the coefficient of variation of young and old males for the temporal and structural acoustic features.

All together, the age specific variation of mean and variability of acoustic features seems to be in accordance with the presence of two simultaneous processes, maturation and vocal learning, the first one affecting the frequency component of sounds that depend on the vocal tract size and shape, and the second one working on temporal and structural features of sounds that are rather free to vary unconstrained by the individual phenotype.

The relationship between formants and age confirms that the formants are constrained by the structural phenotype and can be, in principle, honest signals of age,

conveying a reliable information about the resource holding potential of the emitter (Fitch and Hauser, 2002), at least in a rough way and for a part of the lifespan. Another acoustic feature of SES male vocalizations, the source level, has been shown to be related to the structural phenotype and, hence, to be a good candidate as honest signal (Sanvito and Galimberti, 2003; see Chapter 6). The relationship between formants and age was only moderate in strength, and the percentage of variance explained by the relationship was rather low, around 40% for the highest formant. These results are in line with some recent findings obtained in another polygynous mammal, with a similar mating system, the red deer (*Cervus elaphus*, Reby and McComb 2003). The same relationship of decrease in formant frequency with age was demonstrated, although, also in that case, the percentage of variance in formant frequency explained by age variation was rather low.

I have previously shown (Chapter 4) that young males tend to mimic and adopt the vocal type of older, more successful males. This result seems confirmed by the ontogenetic trend found for the temporal and structural features of their vocalizations. Young elephant seals seem to be able to produce the same pulse trains that are the building blocks of the vocalizations of mature males, but their vocalization are initially extremely variable and not structured (Chapter 4). The increase in structure of the vocalizations is likely to be related to an increase in competence to assemble the pulse trains in a structured complex (Shiple et al. 1986), *i.e.*, a vocal learning process. The result is the emission by adults of strongly structured vocalizations, specific for each individual and stereotyped, and different between individuals, with no clear constraint due to the structural phenotype. The reduction in relative variability of the acoustic features that are not constrained by structural phenotype of males, which is likely a

product of vocal learning, may improve individual recognition (Insley, 1992; Insley et al., 2003).

V.6 LITERATURE CITED

- Bailey R.C., Byrnes J., 1990. A new, old method for assessing measurements error on both univariate and multivariate morphometric studies. *Systematic Zoology*. **39**:124-130.
- Barlow G.W., 1977. Modal action patterns. In: *How animals communicate* (Sebeok T.A. ed). Bloomington: Indiana University Press; 98-134.
- Bekoff M., 1977. Mammalian dispersal and the ontogeny of individual behavioural phenotypes. *American Naturalist*. **111**:715-732.
- Braschi C., 2004. Confronti agonistici nell'elefante marino del sud: fattori coinvolti e ruolo delle asimmetrie tra due maschi (Male agonistic behavior in southern elephant seals: factors and asymmetries involved in conflict((PhD). Roma: Università La Sapienza di Roma.
- Burnham K.P., Anderson D.R., 1998. *Model selection and inference: a practical information-theoretic approach*. New York: Springer.
- Cameron A.C., Trivedi P.K., 1998. *Regression analysis of count data*. Cambridge, UK: Cambridge University Press.
- Charif R.A., Mitchell S., Clark C.W., 1995. *Canary 1.2 user's manual*. Ithaca, NY: Cornell Laboratory Of Ornithology.
- Cheung Y.B., 2002. Zero-inflated models for regression analysis of count data: a study of growth and development. *Stat Med*. **21**:1461-9.

- Clinton W.L., 1994. Sexual selection and growth in male Northern Elephant Seals. In: *Elephant seals. Population ecology, behavior, and physiology* (Boeuf B.J.L., Laws R.M. eds). Berkeley (CA): University of California Press; 154-168.
- Darden S.K., Pedersen S.B., Dabelsteen T., 2003. Methods of frequency analysis of a complex mammalian vocalisation. *Bioacoustics*. **13**:247-263.
- Deutsch C.J., 1990. Behavioral and energetic aspects of reproductive effort of male northern elephant seals (*Mirounga angustirostris*) (Ph.D. Thesis). Santa Cruz (CA): University of California.
- Diggle P.J., Kung-Yee L., Zeger S.L., 1994. *Analysis of longitudinal data*, 1 ed. Oxford: Clarendon Press.
- Egnor R.S.E., Hauser M.D., 2004. A paradox in the evolution of primate vocal learning. *TRENDS in neurosciences*. **27**:649-654.
- Elowson A.M., Snowdon C.T., Sweet C.J., 1992. Ontogeny of Trill and J-Call Vocalizations in the Pygmy Marmoset *Cebuella-Pygmaea*. *Animal Behaviour*. **43**:703-715.
- Enquist M., Leimar O., 1990. The evolution of fatal fighting. *Animal Behaviour*. **39**:1-9.
- Fant G., 1960. *Acoustic Theory of Speech Production*: Mouton, The Hague.
- Fischer J., Kitchen D.M., Seyfarth R.M., Cheney D.L., 2004. Baboon loud calls advertise male quality: acoustic features and their relation to rank, age, and exhaustion. *Behavioral Ecology and Sociobiology*. **56**:140-148.
- Fitch W.T., 1994. Vocal Tract Length Perception and the Evolution of Language (PhD): Brown University.

- Fitch W.T., 1997. Vocal tract length and formant frequency dispersion correlate with body size in rhesus macaques. *Journal of the Acoustical Society of America*. **102**:1213-1222.
- Fitch W.T., 2000. The Phonetic Potential of Nonhuman Vocal Tracts: Comparative Cineradiographic Observations of Vocalizing Animals. *Phonetica*. **57**:205-218.
- Fitch W.T., Hauser M.D., 2002. Unpacking "honesty": vertebrate vocal production and the evolution of acoustic signals. In: *Acoustic Communication* (Simmons A.M., Popper A.N., Fay R.R. eds). New York: Springer-Verlag.
- Fitch W.T., Reby D., 2001. The descended larynx is not uniquely human. *Proceedings of the Royal Society Biological Sciences Series B*. **268**:1669-1675.
- Fry D.B., 1979. *The physics of speech*: Cambridge Univ. Press.
- Galimberti F., Boitani L., 1999. Demography and breeding biology of a small, localized population of southern elephant seals (*Mirounga leonina*). *Marine Mammal Science*. **15**:159-178.
- Galimberti F., Boitani L., Marzetti I., 2000. The frequency and costs of harassment in southern elephant seals. *Ethology Ecology & Evolution*. **12**:345-365.
- Galimberti F., Fabiani A., Boitani L., 2003. Socio-spatial levels in linearity analysis of dominance hierarchies: a case study on elephant seals. *Journal of Ethology*. **21**:131-136.
- Galimberti F., Fabiani A., Sanvito S., 2002. Measures of breeding inequality: a case study in southern elephant seals. *Canadian Journal of Zoology*. **80**:1240-1249.
- Galimberti F., Sanvito S., 2001. Modelling females haul out in southern elephant seals (*Mirounga leonina*). *Aquatic Mammals*. **27**:92-104.

- Galimberti F., Sanvito S., Braschi C., Boitani L., submitted. The cost of success: reproductive effort in male southern elephant seals. *Behavioral Ecology and Sociobiology*.
- Gardner W., Mulvey E.P., Shaw E.C., 1995. Regression analyses of counts and rates: Poisson, overdispersed Poisson, and negative binomial models. *Psychological Bulletin*. **118**:392-404.
- Geist V., 1974. On fighting strategies in animal conflict. *Nature*. **250**:354.
- Gutierrez R.G., Carter S.L., Drukker D.M., 2001. On boundary-value likelihood-ratio tests. *Stata Technical Bulletin*. **60**:15-18.
- Hammerschmidt K., Freudenstein T., Juergens U., 2001. Vocal development in squirrel monkeys. *Behaviour*.
- Hochberg Y., Benjamini Y., 1990. More powerful procedures for multiple significance testing. *Statistics in Medicine*. **9**:811-818.
- Insley S.J., 1992. Mother-offspring separation and acoustic stereotypy: A comparison of call morphology in two species of pinnipeds. *Behaviour*. **120**:103-122.
- Insley S.J., Phillips A.V., Charrier I., 2003. A review of social recognition in pinnipeds. *Aquatic Mammals*. **29**:181-201.
- Job D.A., Boness D.J., Francis J.M., 1995. Individual variation in nursing vocalizations of Hawaiian monk seal pups, *Monachus schauinslandi* (Phocidae, Pinnipedia), and lack of maternal recognition. *Canadian Journal of Zoology*. **73**:975-983.
- Krebs C.J., 1989. *Ecological methodology*. New York: Harper & Row Publishers.
- Laws R.M., 1953. The elephant seal (*Mirounga leonina* Linn.). I. Growth and age. *Scient. Rep. Falkland Is. Depend. Surv.* **8**:1-62.

- Le Boeuf B.J., Laws R.H., 1994. *Elephant seals. Population ecology, behavior and physiology*, 1 ed. Berkeley, CA: University of California Press.
- Le Boeuf B.J., Reiter J., 1988. Lifetime reproductive success in northern elephant seals. In: *Reproductive success. Studies of individual variation in contrasting breeding systems* (Clutton-Brock T.H. ed). Chicago: University of Chicago Press; 344-362.
- Lessells C.M., Boag P.T., 1987. Unrepeatable repeatabilities: a common mistake. *Auk*. **104**:116-121.
- Liu W., Kroodsma D.E., 1999. Song development by chipping sparrows and field sparrows. *Animal Behaviour*. **57**:1275-1286.
- Long J.S., 1997. *Regression models for categorical and limited dependent variables*. Thousand Oaks, CA: Sage Publications.
- Long J.S., Freese J., 2001. *Regression model for categorical depend variables using STATA*. College Station, Texas: STATA Corporation.
- Manly B.F.J., 1997. *Randomization, bootstrap and Monte Carlo methods in biology*. London: Chapman and Hall.
- Markel J., Gray A., 1976. *Linear Prediction of Speech*. New York.
- Maynard Smith J., Harper D.G.C., 1988. The evolution of aggression — can selection generate variability? *Phil. Trans. Roy. Soc. Lond. B*. **319**:557-570.
- McCann T.S., 1981. Aggression and sexual activity of male Southern elephant seals, *Mirounga leonina*. *Journal of Zoology London*. **195**:295-310.
- Miller C., Roussel N., Daniloff R., Hoffman P., 1991. Estimation of formant frequency in synthetic infant CV tokens. *Clin. Ling. Phonet*. **5**:283-296.

- Miller E.H., 1991. Communication in pinnipeds, with special reference to non-acoustic signalling. In: *The behaviour of the Pinnipeds* (Renouf D. ed). London: Chapman and Hall; 128-235.
- Miller E.H., Murray A.V., 1995. Structure, complexity, and organization of vocalizations in harp seals (*Phoca groenlandica*). In: *Sensory systems of aquatic mammals* (Kastelein R.A., Thomas J.A., Nachtigall P.E. eds). Woerden, The Netherlands: De Spil Publishers; 237-264.
- Mitchell-Olds T., Shaw R.G., 1987. Regression analysis of sexual selection: statistical inference and biological interpretation. *Evolution*. **41**:1149-1161.
- Monsen R., Engebretson A., 1983. Accuracy of formant frequency measurements: a comparison of spectrographic analysis and linear prediction. *J. Speech Hear. Res.* **26**:89-97.
- Muggeo V.M., 2003. Estimating regression models with unknown break-points. *Stat Med.* **22**:3055-71.
- Owren M., Linker C., 1992. Some analysis methods that may be useful to acoustic primatologists. In: *Current Topics in Primate Vocal Communication* (Elke Z. ed). New York and London: Plenum Press; 1-28.
- Owren M.J., Bernacki R.H., 1988. The acoustic features of vervet monkey alarm calls. *Journal of the Acoustical Society of America*. **83**:1927-1935.
- Phillips A.V., Stirling I., 2000. Vocal individuality in mother and pup South American fur seals, *Arctocephalus australis*. *Marine Mammal Science*. **16**:592-616.
- Press W.H., Flannery B.P., Teukolsky S.A., Vetterling W.T., 1989. *Numerical recipes in Pascal: the art of scientific computing*. Cambridge: Cambridge Un. Press.

- Reby D., McComb K., 2003. Anatomical constraints generate honesty: acoustic cues to age and weight in the roars of red deer stags. *Animal Behaviour*. **65**:519-530.
- Riede T., Fitch T., 1999. Vocal tract length and acoustics of vocalization in the domestic dog (*Canis familiaris*). *Journal of Experimental Biology*. **202**:2859-2867.
- Robb M.P., Cacace A.T., 1995. Estimation of formant frequencies in infant cry. *International Journal of Pediatric Otorhinolaryngology*. **32**:57-67.
- Sandegren F.E., 1976. Agonistic behavior in the male Northern Elephant seal. *Behaviour*. **57**:136-158.
- Sanvito S., 1997. Struttura, ontogenesi e funzione dei vocalizzi maschili nell' elefante marino del sud (*Mirounga leonina*) [Structure, ontogeny and function of male vocalizations in southern elephant seals (*Mirounga leonina*)] (Degree Thesis). Milano, Italy: Università degli Studi di Milano.
- Sanvito S., Galimberti F., 2000a. Bioacoustics of southern elephant seals. I. Acoustic structure of male aggressive vocalizations. *Bioacoustics*. **11**:259-285.
- Sanvito S., Galimberti F., 2003. Source level of male vocalizations in the genus *Mirounga*: repeatability and correlates. *Bioacoustics*. **14**:45-57.
- Shiple C., Hines M., Buchwald J.S., 1981. Individual differences in threat calls of northern elephant seal bulls. *Animal Behaviour*. **29**:12-19.
- Shiple C., Hines M., Buchwald J.S., 1986. Vocalizations of northern elephant seal bulls: development of adult call characteristics during puberty. *Journal of Mammalogy*. **67**:526-536.

- Shiple C., Stewart B.S., Bass J., 1992. Seismic communication in Northern elephant seals. In: *Marine Mammal Sensory System* (al. J.T.e. ed). New York: Plenum press; 553-562.
- Siegel S., Castellan N.J., 1988. *Non parametric statistics for the behavioral sciences*. New York: McGraw Hill.
- Smallwood J.A., Dudajek V., Gilchrist S., Smallwood M.A., 2003. Vocal development in American Kestrel (*Falco sparverius*) nestlings. *Journal of Raptor Research*.
- Snowdon C.T., Hausberger M., 1997. *Social influences on vocal development (book review)*. Cambridge: Cambridge University Press.
- Sokal R.R., Braumann C.A., 1980. Significance tests for coefficients of variation and variability profiles. *Systematic Zoology*. **29**:50-66.
- Trexler J.C., Travis J., 1993. Nontraditional regression analysis. *Ecology*. **74**:1629-1637.
- Tyack P.L., 1997. Development and social functions of signature whistles in bottlenose dolphins *Tursiops truncatus*. *Bioacoustics*. **8**:21-46.
- Van Parijs S.M., Corkeron P.J., 2002. Ontogeny of vocalizations in infant black flying foxes, *Pteropus alecto*. *Behaviour*. **139**:1111-1124.
- Vuong Q.H., 1989. Likelihood ratio tests for model selection and non-nested hypotheses (STMA V31 0456). *Econometrica*. **57**:307-333.
- Williams R.L., 2000. A note on robust variance estimation for cluster-correlated data. *Biometrics*. **56**: 56: 645–646.
- Zuberbuhler K., Noé R., Seyfarth R.M., 1997. Diana monkey long-distance calls: messages for conspecifics and predators. *Animal Behaviour*. **53**:589-604.

VI - Source level of male vocalizations in the genus Mirounga: repeatability and correlates

(Published in *Bioacoustics*, 2003. 14:47-59)

VI.1 ABSTRACT

Male vocalizations have an important role in mating tactics, breeding strategies and sexual selection. Most studies of vocalizations are concentrated on the time and frequency domains, while the intensity of sound, an important acoustic parameter that should be related to body size, is almost completely ignored as a possible honest signal of resource holding potential (RHP), and cue for mate choice. In this paper, I analyse the repeatability, the correlations with age and size, and the relationship with breeding status of source level (SL) of male vocalizations in the two species of elephant seals (*Mirounga leonina* and *M. angustirostris*). I found a high repeatability of SL, equal or higher than the repeatability of frequency domain parameters estimated in a previous study. Southern elephant seal males were significantly larger and produced significantly more powerful vocalizations than northern males. Moreover, in each species SL was related to age, body size, and breeding status of males, but relationships were weak, and explained just a small proportion of variance of SL. I conclude that, although SL may be an honest signal of gross differences of RHP, it is not, by itself, a good candidate for the transmission of high resolution information on individual phenotype. A combination of SL and frequency components could be, on the contrary, an effective way to communicate RHP.

VI.2 INTRODUCTION

There is an increasing interest in the evolution and function of animal acoustic communication (Simmons et al., 2002). Male vocalizations have an important role in various aspects of mating tactics evolution and sexual selection, including individual recognition of neighbouring males (Fernández-Juricic et al., 1999), male competition for mates (Clutton-Brock and Albon, 1979; McElligott et al., 1999), and female choice (McComb, 1991). Most studies on the structural and functional correlates of male vocalizations were focused on time and frequency domains (Simmons et al., 2002). There is very limited information regarding another important aspect of vocalizations, the absolute intensity of sound, usually measured as source level (SL), *i.e.*, the sound pressure level (SPL = the logarithm of the ratio between the sound pressure emitted and a standard reference pressure, 20 μ Pa in air: Charif et al., 1995) measured at 1 m distance from the source, and on the acoustic axis.

There is very limited information on SL of animal species, and SL has very rarely been measured in wild-living mammal species in the air, although measurements are available for vocalizations emitted by marine mammals in the water (Rasmussen et al., 2002). SL was measured in the air in only one *Pinnipedia* species, the California sea lion (*Zalophus californianus*; Schusterman, 1978). The lack of information on absolute SL in free-ranging individuals is probably related to the practical problems involved in getting calibrated measurements of animal vocalizations, in particular in the field (Nelson, 2000). The measurement of SL requires a standardization of the distance from the source, a task

that is not easily accomplished in field work settings.

In humans, SL depends on the lung size that is, in turn, mainly related to body size, although the relationship is not strict, and many other factors are involved (Titze, 1994). This relationship can be expected to hold also in other mammals that have a similar sound production mechanism. Therefore, SL may convey information about the phenotype of the male, and can be an “honest” signal of its resource holding potential (Fitch and Hauser, 2002; Kotiaho et al., 1999). Notwithstanding this, the relationship between SL and body size has never been tested in any mammalian species, to my best knowledge (e.g., a standard textbook on animal communication, Bradbury and Vehrencamp, 1998, contained no reference on this relationship).

Male vocalizations are a very important component of competition for access to females in the species of the genus *Mirounga* (Bartholomew and Collias, 1962; Sanvito and Galimberti, 2000a). Male elephant seals interact at short distances (0-50 m) by facing one another and using a mixture of conventional display and direct fight, in which the audio component plays a main role (in one of the study populations more than 70% of agonistic interactions includes a vocal display; Fabiani, 1996). A specific problem of the use of amplitude cues in the transmission of information is that the perception of these cues, contrary to time and frequency domain cues, can be strongly affected by the orientation and distance of the emitter. The effect of orientation should be of minor importance in the *Mirounga* genus, because males interact by facing one each other at short distance. There is no published information about the capability of elephant seals to evaluate distances. Being a predator species, they should be able to well estimate the

actual distance of opponents, also because the mean interaction distance is short, its range is limited and the breeding habitat is fully open.

In this study, I present data on field measurements of SL in free ranging males of southern (*M. leonina*; hereinafter SES) and northern elephant seals (*M. angustirostris*; hereinafter NES). I calculate individual repeatability of SL, compare SL among the two species, and analyse the structural and functional correlates of SL, focusing on age class, body length, and breeding status.

VI.3 METHODS

Field work was carried out on southern elephant seals during four breeding seasons (1996-1998 and 2000) at Sea Lion Island (Falkland Islands; hereinafter SLI), and on northern elephant seals during one breeding season (2001) at San Benitos Islands (Baja California, Mexico; hereinafter SBI). In both cases, the local population was rather small, with 40-70 breeding males per season. Males were marked using commercial hair dye. At SLI, they were also tagged (Jumbo Rototags, Dalton Supplies Ltd.) to permit recognition among years. Additional information on the marking protocol is presented elsewhere (Galimberti and Boitani, 1999).

SL (in dB) was measured with a digital sound level meter (Model 1400, Quest Technologies), in a standard condition of solicitation of males (Sanvito and Galimberti, 2000a). Elephant seals react to human approach with the same stereotyped aggression pattern that they use during interactions with other males, starting with the emission of aggressive vocalizations. The sound level meter was fitted with a 1 meter long reference

pole, and the tip of the pole was kept between the lower canines of the male during measurement. To avoid the transmission of vibration the pole was not in contact neither with the animal nor the microphone of the sound level meter. I measured the maximum SL of each bout in a vocalization (using the peak hold function of the instrument), and then averaged the bout measurements to obtain an average vocalization SL (see (Sanvito and Galimberti, 2000a). The sound level meter was set to “C” weighing and “FAST” response, and fitted with a windscreen to reduce wind noise. At SLI, I measured the SL of 1342 vocalizations made by 162 males (mean = 7.1 to 9.6 vocalizations per male; details in Table VI.1). From vocalization SL I calculated the mean SL of each male, and I used these mean values (= “individual SL”) to analyse correlates of SL. Twenty-five males (18.4%) were present for 2-4 seasons (61 seasonal values, mean = 2.4 ± 0.65 per male), while 111 more were measured in one season only. Although I were aware of the risk of pseudo-replication (Bart et al. 1998), I considered independent the seasonal values of males that were measured in more than one season. Repeated values represented only 37.6% of the data set, and the number of repetitions per male was low, with just 2 males (1.5%) with four seasons, and 7 (5.1%) with three. Moreover, male elephant seals present a significant growth spur after puberty (McLaren, 1993) and, therefore, they experience such a large variation in structural and behavioural phenotype (Clinton, 1994), that consecutive yearly values may be considered biologically independent. To examine the effect of non-independence of individual data points across years, I replicated some of the analysis by selecting a single breeding season at random for males present in more than one, and I obtained qualitatively similar results to the full analysis, although the power of each statistical test was lower due to the smaller sample size. Hence, I am presenting the

Table VI.1 - Samples, SL repeatability, and individual SL statistics. Statistics of vocalizations per male presented as mean \pm standard deviation, with range in parentheses. R = repeatability; P = probability of the randomization test on R, 10000 replicates; 95% CI = 95% asymptotic confidence interval for R. SD = standard deviation, CV = coefficient of variation

Species/Site	Year	N° voc.	N° males	Voc. per male	R	P	95% CI	Mean	SD	Min	Max	CV
SES/SLI	1996	288	34	8.5 \pm 4.7 (2-22)	0.769	0.0000	0.664-0.874	110.5	3.34	102.9	116.0	0.030
	1997	460	48	9.6 \pm 5.5 (3-27)	0.715	0.0000	0.613-0.817	110.1	3.22	102.9	116.1	0.029
	1998	268	34	7.9 \pm 4.5 (3-22)	0.760	0.0000	0.653-0.870	110.7	3.16	104.9	118.3	0.029
	2000	326	46	7.1 \pm 4.4 (2-20)	0.627	0.0000	0.502-0.756	111.0	2.65	105.9	119.7	0.024
	All							110.6	3.07	102.9	119.7	0.028
NES/SBI	2001	245	17	14.4 \pm 7.3 (3-28)	0.740	0.0000	0.589-0.897	104.2	3.51	98.5	111.2	0.034

results of the full analysis only. At SBI I measured SL of 245 vocalizations made by 17 males (mean = 14.4 ± 7.3 vocalizations per male) during one breeding season only.

Males were classified in increasing age categories by two independent observers both at SLI and SBI, using a standard nomenclature in use for both northern and southern elephant seals (SAM1 = sub-adult male class 1, SAM2 = sub-adult male class 2, SAM3 = sub-adult male class 3, SAM4 = sub-adult male class 4, AD = adult male; e.g., Deutsch et al. 1994). Classes were based on morphology of the male, in particular scarring of the chest and development of the proboscis, and not on body size. Classification was found to be reliable at SLI (Galimberti and Boitani, 1999). To test reliability of the SBI classification, I ordered categories and converted them to ranks. Correlation among the independent classification of the two observers was very high (Spearman rank correlation, with randomization test: $\rho = 0.955$, $n = 57$ males, $P < 0.0001$).

I determined male size by visually comparing them in the field, and by using a photogrammetric method (Haley et al., 1991). Each observer produced an ordering of males by repeatedly comparing size among dyads of resting males. The ordering of each observer was then converted to ranks, and ranks were compared among observers. Agreement was very high (three breeding season, Spearman rank correlation, with randomization test: ρ ranging from 0.972 to 0.985, P always < 0.0001). A consensus rank (mean between ranks attributed by observers) was then used in the analysis. Nose to tail body length was calculated from pictures of males resting on packed sand taken from the side, and including a calibrated surveying pole in the frame. Repeatability of body length of SES males as measured using the photogrammetric method was high both in 1996 (90 measurements for 24 males, 3.8 ± 1.9 per male; $R = 0.839$, $P = 0.0000$, 95%

confidence interval = 0.736-0.942) and 1997 (76 measurements for 26 males, 2.9 ± 1.3 per male; $R = 0.869$, $P = 0.0000$, 95% confidence interval = 0.783-0.954). For NES males repeatability was also high, although the sample size was much smaller (28 measurements for 10 males, 2.8 ± 1.1 per male, $R = 0.942$, $P = 0.0000$, 95% confidence interval = 0.876-1.000).

Statistics are presented as mean \pm standard deviation. Repeatability was calculated using variance components (Lessells and Boag, 1987), and was tested for significance using randomization, to avoid bias due to uneven number of replicates per male. Being a ratio between variance components, repeatability is a relative measure that can be used to compare variables measured on different scales, and with different accuracy and precision (e.g., Becker, 1984). Calculations and tests were run in StatView 5 (SPSS Inc.) and Stata 7 (Stata Corp.).

VI.4 RESULTS

VI.4.1 Source level

Yearly statistics for individual SL are presented in Table VI.1. Repeatability of SL was high both at SLI and SBI (Table VI.1). Intra-individual variation of SL was low, with coefficient of variation in the range 0.001-0.047 (mean = 0.014). Individual SL had a normal distribution both at SLI (Shapiro-Wilk test: $W = 0.95-0.98$, $P > 0.14$ in all years) and SBI ($W = 0.98$, $P = 0.94$) and it was homogeneous among years at SLI ($F_{3,158} = 0.728$, $P = 0.54$).

VI.4.2 Differences among the species

SES males were larger than NES males (380.4 ± 27.8 cm, $n = 50$ vs 308.6 ± 29.0 , $n = 10$; mean difference = -71.8 cm; Unpaired samples t-test: $t_{58} = -7.412$, $P < 0.0001$). SL was much higher in the southern elephant seal than in the northern (mean difference = 6.4 dB; Unpaired samples t-test: $t_{177} = 8.070$, $P < 0.0001$), while variance was homogeneous (F test: $F_{16,161} = 1.301$, $P = 0.48$). The difference was significant also when comparing the northern species with each year of the southern (Figure VI.1).

VI.4.3 Correlations with male phenotype

At SLI, although there was an increase in SL with age (mean difference between SAM1 and AD = 2.2 dB), intermediate sub-adult classes had similar SL, there was a large overlap of confidence limits (Figure VI.2) and, as a whole, the difference between age classes was not significant (ANOVA: $F_{4,148} = 1.633$, $P = 0.1689$). Only A males had an higher SL than other males (mean difference = 1.103 dB; $t_{151} = 2.134$, $P = 0.0345$). At SBI, due the small sample, I were only able to compare SAM4 and AD. Adults had an higher SL (mean difference = 3.564 dB; Unpaired samples t-test: $t_{13} = 2.084$, $P = 0.0575$).

At SLI, the dataset included 27 to 34 males per year for which both individual SL and size rank were available. There was a negative (*i.e.*, increase of SL with increase in size), but non significant, correlation between SL and size rank in all four years of study (Spearman rank correlation: $\rho = -0.259$ to -0.308 , $P = 0.10$ to 0.11). A similar result was found in NES at San Benitos ($\rho = -0.396$, $n = 17$, $P = 0.11$). A photogrammetric estimate of body length was available for two breeding seasons at SLI, 1996 ($n = 18$

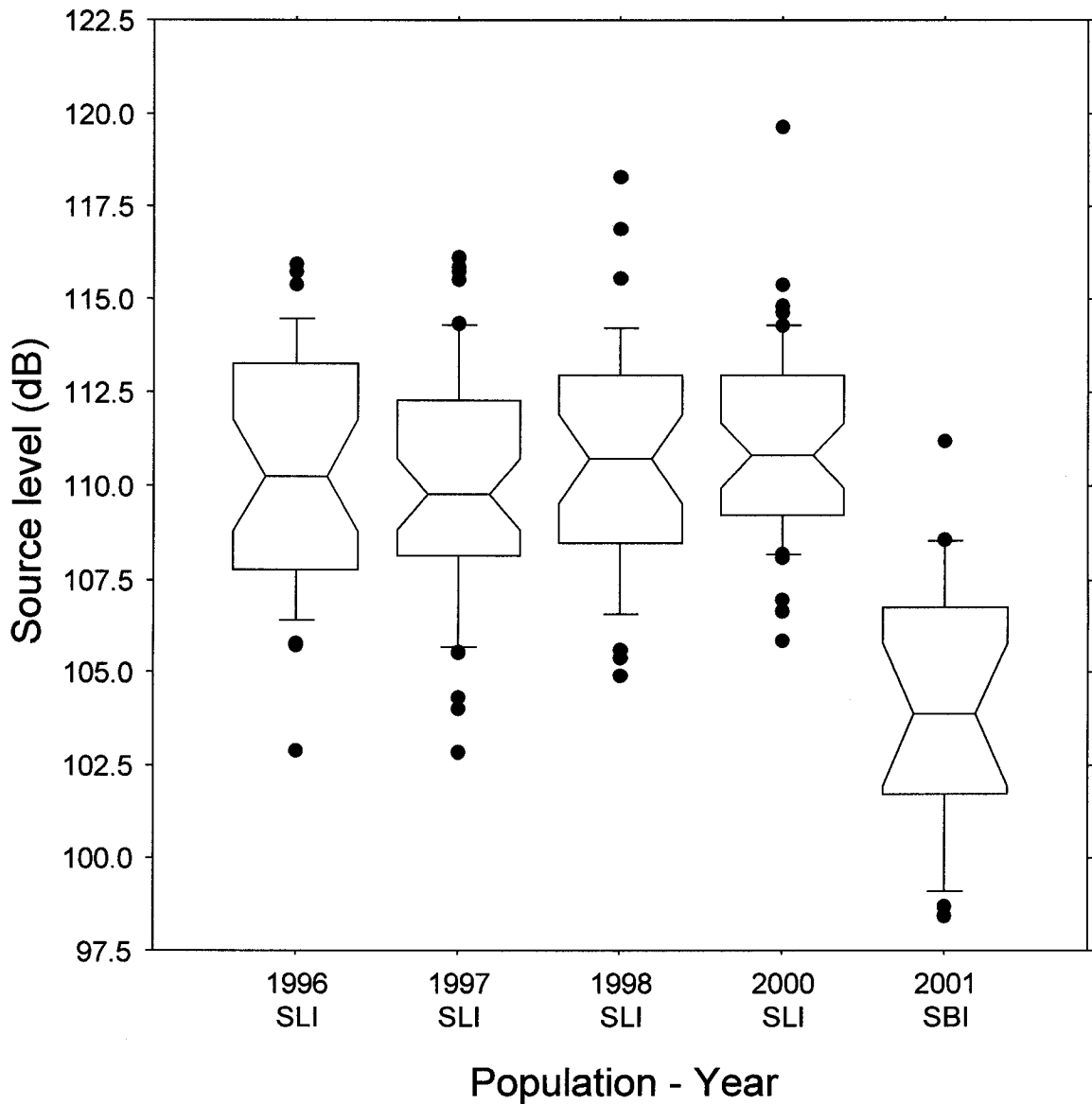

Figure VI.1 - Boxplots of SL split by population and year. Notches in the boxes represent 95% confidence intervals around the median (each box is notched at the median, and return to full width at the lower and upper confidence limits; McGill et al. 1978), so visual comparison of the notched boxes is a non-parametric test of differences between years and populations. 1996-1998 and 2000 southern elephant seals of SLI; 2001 northern elephant seals of SBI.

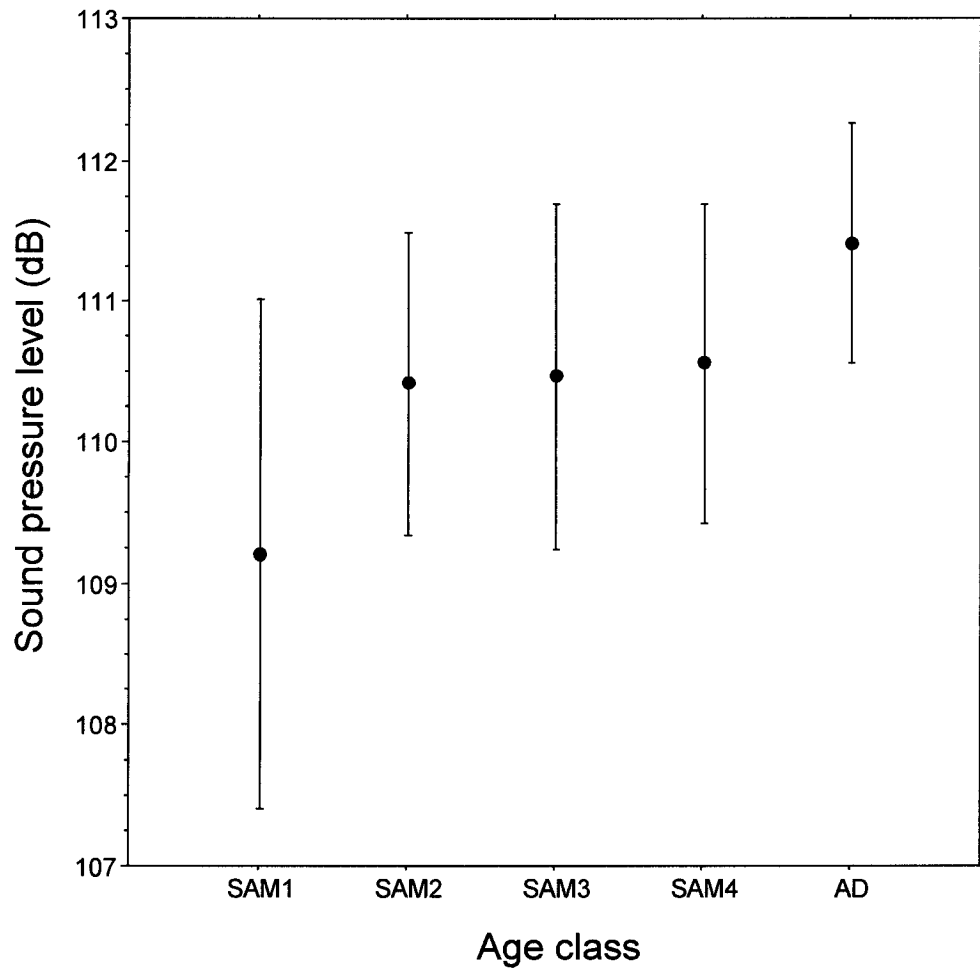

Figure VI.2 - Mean and 95% confidence interval of SL of southern elephant seal age classes.

males with measured SL) and 1997 (n = 17 males). Yearly sample size was small, and individual measures were homogeneous both for SL (mean difference = 0.333 dB; Unpaired samples t-test: $t_{33} = 0.310$, $P = 0.76$) and body length (mean difference = 6.2 cm; Unpaired samples t-test: $t_{33} = 0.744$, $P = 0.46$), so I pooled the data. SL significantly increased with body length (Linear regression: n = 35 males, $b = 0.061$, $se(b) = 0.019$, $t = 3.15$, $P = 0.0034$), but there was a large dispersion of points (Figure VI.3), the proportion of SL variance explained by body length variance was low ($R^2 = 0.232$), and the 95% confidence interval of the regression coefficient was rather large (0.022-0.101).

Harem holders had a higher SL than non-holders both at SLI (mean difference = 1.209 dB; Unpaired samples t-test: $t_{160} = 2.204$, $P = 0.0289$) and SBI, although in the latter case the difference was non significant (but note the high effect size and low power: mean difference = 3.065 dB; $t_{15} = 1.741$, $P = 0.1022$; effect size $d = 0.87$, post-hoc power = 0.47).

VI.5 DISCUSSION

To be a reliable signal of resource holding potential, source level should be a good individual trait, being stable within, and variable between, individuals. Moreover, it should be correlated to one or more structural trait of the individual phenotype that may affect the outcome of agonistic contests. In elephant seals, fighting success and dominance rank are related to age and body size, and determine mating success (Haley et al., 1994; McCann, 1981).

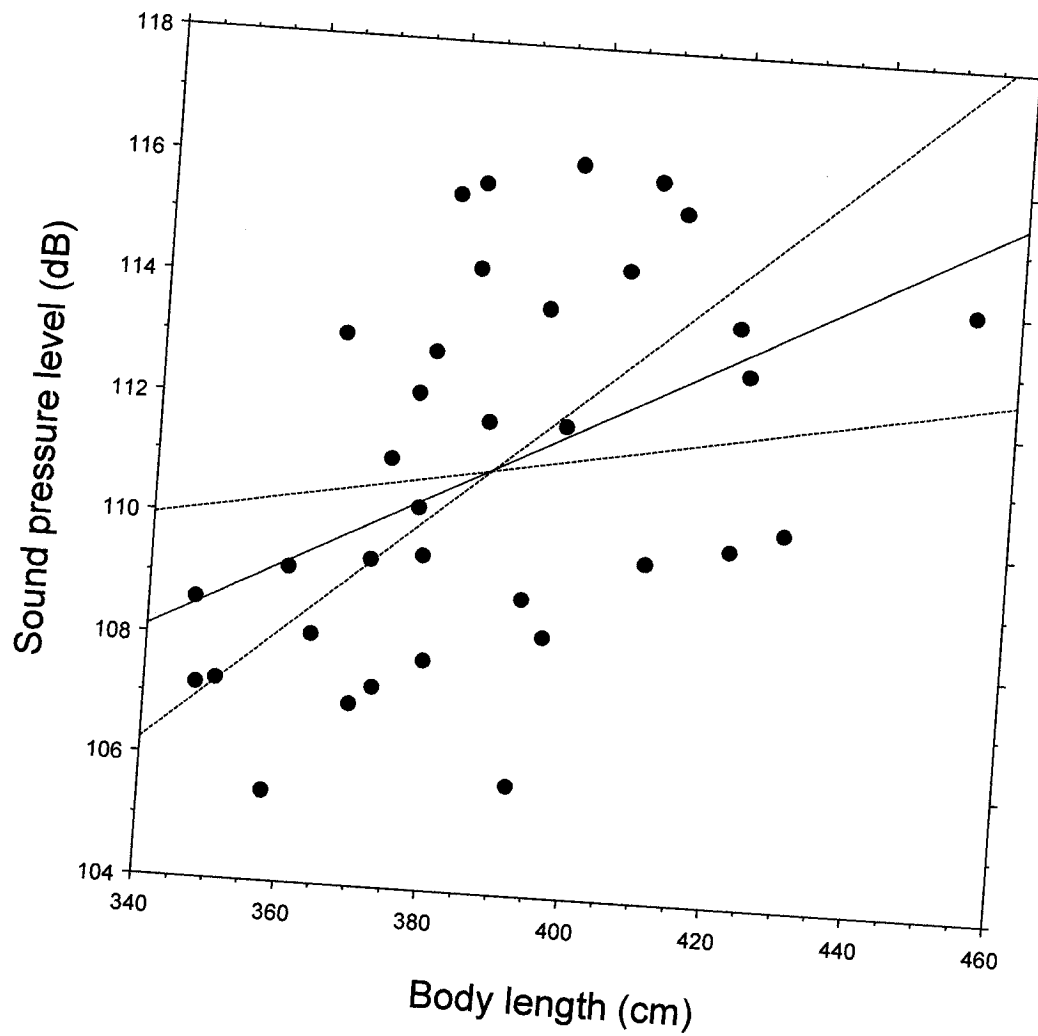

Figure VI.3 - Scatterplot of SL versus nose-tail length as estimated by the photogrammetric method in southern elephant seals. Solid line is linear regression, dashed lines are 95% confidence limits for the regression slope.

My study demonstrates that SL has a high repeatability both in southern and northern elephant seals. In a previous article (Sanvito and Galimberti, 2000b) I showed that various time and frequency domain aspects of elephant seal vocalizations are repeatable. SL is very repeatable at the individual level, even more than frequency characteristics of vocalizations, that are usually considered a good indicator of individual size. For example, in my sample of SES males, SL is more repeatable than fundamental frequency, which is related to vocal fold size (Titze, 1994) and, in frogs and toads, is a reliable index of body size (Ryan 1980; but contrasting results were found in some vertebrate species; Fitch, 1997). SL is also more repeatable than formant frequencies which, in primates and humans, are a good index of body size, being directly correlated with vocal tract size (Fitch, 1997; Riede and Fitch, 1999). SL in my study is stable enough within individuals to be considered a good individual trait and a potential cue of body size.

Information about the mechanism of vocalization production in elephant seals is almost completely lacking. The same holds in general for SL regulation in mammal vocalizations. In humans and primates, SL depends on lung size and pressure, size and shape of the sound source and the sound resonator (respectively the vocal folds and vocal tract), pressure developed in the rest of the vocal tract, and musculature (Åkerlund and Gramming, 1994; Titze, 1994). Since lung size and body size are correlated in vertebrates, any acoustic measure related to lung size is also related to body size (Fitch and Hauser, 2002). Elephant seals should have a similar SL regulation system, but further studies on the mechanism of vocalization production are badly needed. In elephant seals, SL is related to age class and size of the male, but the relationship is not very strong, and

it is quite variable. Only the extreme age classes present a significant difference, and just a small proportion of the variance in SL is explained by the variance in body size. On the other hand, when comparing the two species of the genus *Mirounga*, which may be considered the extremes of the body size range of the genus, the difference in SL is very large and significant. This seems to be in agreement with the results obtained in humans. Due to complexity of the mechanism of SL regulation, large adult males are able to emit more powerful sound than smaller and younger ones, but there is a lot of variation in this trend, because many factors other than size are involved (Titze, 1994). Moreover, age may reflect “training” and “experience”, two important factors in sound production. In humans, training in voice production affects SL performance (Åkerlund and Gramming, 1994). This may explain the increase of SL with age in elephant seals, that may adjust vocalizations to maximize SL during development. This is not surprising, since there is a clear development in the individual capability of vocal production in both species of the genus *Mirounga* (Sanvito, 1997; Shipley et al., 1986).

SL of male vocalizations may convey information on gross differences between phenotype classes, (i.e., adults versus non adults, big versus small), but is not enough correlated to the structural phenotype to be a good candidate for the transmission of high resolution information on resource holding potential of individuals. In humans, SL and fundamental frequency are closely related (Titze, 1994); if lung pressure is kept constant, SL increases with increased fundamental frequency, which explains why children and adult males may reach similar absolute SL, but at different frequencies. This probably holds for other mammals as well. A small oscillator can produce low frequency oscillations, but its capability to convert their energy to emitted acoustic energy is

physically constrained (Hauser et al., 2002). Therefore, there is a structural trade-off between low frequency and high power of sound emission, a trade-off that bigger animals are better suited to overcome than smaller ones. Older elephant seal males are, in fact, able to emit lower pitched vocalizations than younger ones, while maintaining high SL (Sanvito, 1997). Therefore, absolute SL alone may give only a rough indication of size, but the combination of frequency domain structure (fundamental frequency and formant frequencies in particular) and SL may be a much better index of it.

VI.6 LITERATURE CITED

- Åkerlund L., Gramming P., 1994. Average loudness level, mean fundamental frequency, and subglottal pressure: Comparison between female singers and nonsingers. *Journal of Voice*. **8**:263-270.
- Bartholomew G.A., Collias N.E., 1962. The role of vocalization in the social behaviour of the Northern Elephant Seal. *Animal Behaviour*. **10**:7-14.
- Becker W.A., 1984. *A manual of quantitative genetics*. Washington: Pullman.
- Bradbury J.W., Vehrencamp S.L., 1998. *Principles of Animal Communication*. Massachusetts: Publishers. Sunderland.
- Charif R.A., Mitchell S., Clark C.W., 1995. *Canary 1.2 user's manual*. Ithaca, NY: Cornell Laboratory Of Ornithology.
- Clinton W.L., 1994. Sexual selection and growth in male Northern Elephant Seals. In: *Elephant seals. Population ecology, behavior, and physiology* (Boeuf B.J.L., Laws R.M. eds). Berkeley (CA): University of California Press; 154-168.
- Clutton-Brock T.H., Albon S.D., 1979. The roaring of red deer and the evolution of honest advertisement. *Behaviour*. **69**:145-170.
- Fabiani A., 1996. Aspetti strutturali e funzionali del comportamento agonistico maschile nell' elefante marino del sud (*Mirounga leonina*) [Structural and functional aspects of male agonistic behaviour in southern elephant seals (*Mirounga leonina*)] (Degree Thesis). Roma, Italy: Università degli Studi di Roma "La Sapienza".

- Fernández-Juricic E., Campagna C., Enriquez V., Ortiz C.L., 1999. Vocal communication and individual variation in breeding South american sea lions. *Behaviour*. **136**:495-517.
- Fitch W.T., 1997. Vocal tract length and formant frequency dispersion correlate with body size in rhesus macaques. *Journal of the Acoustical Society of America*. **102**:1213-1222.
- Fitch W.T., Hauser M.D., 2002. Unpacking "honesty": vertebrate vocal production and the evolution of acoustic signals. In: *Acoustic Communication* (Simmons A.M., Popper A.N., Fay R.R. eds). New York: Springer-Verlag.
- Galimberti F., Boitani L., 1999. Demography and breeding biology of a small, localized population of southern elephant seals (*Mirounga leonina*). *Marine Mammal Science*. **15**:159-178.
- Haley M.P., Deutsch C.J., Le Boeuf B.J., 1991. A method for estimating mass of large pinnipeds. *Marine Mammal Science*. **7**:157-164.
- Haley M.P., Deutsch C.J., Le Boeuf B.J., 1994. Size, dominance and copulatory success in male northern elephant seals, *Mirounga angustirostris*. *Animal Behaviour*. **48**:1249-1260.
- Hauser M.D., N. C., Fitch T., 2002. The Faculty of Language: What Is It, Who Has It, and How Did It Evolve? *Science*. **298**:1569-1579.
- Kotiaho J.S., Alatalo R.V., Mappes J., Parri S., 1999. Honesty of agonistic signalling and effects of size and motivation asymmetry in contests. *Acta Ethologica*. **2**:13-21.
- Lessells C.M., Boag P.T., 1987. Unrepeatable repeatabilities: a common mistake. *Auk*. **104**:116-121.

- McCann T.S., 1981. Aggression and sexual activity of male Southern elephant seals, *Mirounga leonina*. *Journal of Zoology London*. **195**:295-310.
- McComb K., 1991. Female choice for high roaring rates in red deer, *Cervus elaphus*. *Animal Behaviour*. **41**:79-88.
- McElligott A.G., O'Neill K.P., Hayden T.J., 1999. Cumulative long-term investment in vocalization and mating success of fallow bucks, *Dama dama*. *Animal Behaviour*. **57**:1159-1167.
- McLaren I.A., 1993. Growth in pinnipeds. *Biological Reviews*. **68**:1-70.
- Nelson B.S., 2000. Avian dependence on sound pressure level as an auditory distance cue. *Animal Behaviour*. **59**:57-67.
- Rasmussen M.H., Miller L.A., Au W.W.L., 2002. Source levels of clicks from free-ranging white-beaked dolphins (*Lagenorhynchus albirostris* Gray 1846) recorded in Icelandic waters. *Journal of the Acoustical Society of America*. **111**:1122-1125.
- Riede T., Fitch T., 1999. Vocal tract length and acoustics of vocalization in the domestic dog (*Canis familiaris*). *Journal of Experimental Biology*. **202**:2859-2867.
- Ryan M.J., 1980. Female mate choice in a Neotropical frog. *Science*. **209**:532-535.
- Sanvito S., 1997. Struttura, ontogenesi e funzione dei vocalizzi maschili nell' elefante marino del sud (*Mirounga leonina*) [Structure, ontogeny and function of male vocalizations in southern elephant seals (*Mirounga leonina*)] (Degree Thesis). Milano, Italy: Università degli Studi di Milano.
- Sanvito S., Galimberti F., 2000a. Bioacoustics of southern elephant seals. I. Acoustic structure of male aggressive vocalizations. *Bioacoustics*. **11**:259-285.

- Sanvito S., Galimberti F., 2000b. Bioacoustics of southern elephant seals. II. Individual and geographical variation in male aggressive vocalizations. *Bioacoustics*. **11**:287-307.
- Schusterman R.J., 1978. Vocal communications in pinnipeds. In: *Behavior of captive wild animals* (Markowitz H.S., V.J. ed). Chicago: Nelson-Hall; 247-308.
- Shiple C., Hines M., Buchwald J.S., 1986. Vocalizations of northern elephant seal bulls: development of adult call characteristics during puberty. *Journal of Mammalogy*. **67**:526-536.
- Simmons A.M., Popper A.N., Fay R.R., 2002. *Acoustic communication*. New York: Springer-Verlag.
- Titze I.R., 1994. *Principles of voice production*. Engelwood Cliffs: Prentice hall.

VII - Vocal signalling of male southern elephant seals is honest but imprecise

(In press in *Animal Behaviour*)

VII.1 ABSTRACT

In the most common models of communication, it is assumed that animals provide reliable information about phenotype, hence can settle competitive contests without physical interactions like fights. This assumption has been tested rarely for wild mammals. Recent studies of mammals have revealed relationships of vocal attributes to age and body size. Here, I analyze relationships of frequency attributes of agonistic vocalizations to phenotype (age, body size, proboscis size, agonistic behaviour) in the southern elephant seal (*Mirounga leonina*), a species with intense male competition for access to females, and in which vocalizations are used frequently to settle male-male contests. I analyze formant structure and vocal-tract size, and suggest that nasal and oral components of the vocal tract contribute separately to vocal formants; hence the male's proboscis seems to serve to elongate the vocal tract. Next I demonstrate that formants in the upper part of the frequency spectrum (4th and 5th in particular) and formant dispersion convey significant information about age, size, and resource holding potential at large, and, therefore, can be honest signals of the phenotype of the emitter. Explained variance is statistically significant in our and similar studies but is not high (maximum of 40% of body length variance explained by F5, F2 and minor formant together using a stepwise

multiple regression model), so formant structure cannot serve as the sole basis of acoustic assessment. Other possible sources of information exchanged in elephant seal contests are non vocal acoustic signals (*i.e.* vibrations) and optical displays.

VII.2 INTRODUCTION

Vocal communication is an important component of sexual competition in many animal species (Andersson, 1994), often playing a crucial role in determining the outcome of agonistic contests. It has been frequently suggested that acoustic signals may convey information about the phenotype of the emitter and, hence, be *honest* signals (Clutton-Brock and Albon, 1979; Fitch and Hauser, 2002; Harper, 1991; Kitchen et al., 2003; Morton, 1977; Reby and McComb, 2003). Elephant seals (genus *Mirounga*) are an excellent model to study honesty of acoustic signals, due to the intense competition between males for access to females (Galimberti et al., 2002), and the widespread use of vocalizations (Sanvito and Galimberti, 2000a). Although males are sometimes involved in direct fights (Haley, 1994), the vast majority of social interactions between males include a vocal display, and a large percentage of contests are settled by vocalization only (Braschi, 2004). Although the role of vocalizations in male elephant seals behaviour was recognized from the very beginning (Bartholomew and Collias, 1962; Laws, 1956), no detailed information on the acoustic structure of male vocalizations was available until recently (Sanvito and Galimberti, 2000a and 2000b). Moreover, most of the research effort was concentrated on the northern species of the genus only (*M. angustirostris*; Le Boeuf and Peterson, 1969; Le Boeuf and Petrinovich, 1974; Sandegren, 1976; Shipley et al., 1981; Shipley et al., 1986). Although the literature contains various anecdotal statements about the role of male vocal behaviour in elephant seal reproduction (McCann, 1981; Sandegren, 1976), there was almost no attempt to test specific hypotheses about the function of vocalizations.

I recently showed that the source level of male elephant seals vocalizations is only a rough indicator of the emitter's RHP (Sanvito and Galimberti, 2003), while simple temporal and structural acoustic features are almost unrelated to male phenotype (unpublished data), and are likely produced by an imitative learning process, possibly favouring individual recognition (Chapter 5). The recent application of the "source-filter" theory of vocal production to mammals' vocalizations is giving a new opportunity to understand how mammal vocalizations may convey reliable information on the emitter's phenotype through their spectral structure. The source-filter model of voice production was initially developed for human speech (Fant, 1960), but it was later successfully extended to the vocalizations of other mammal species (Fitch, 1994; Fitch, 2000). Vocalizations emitted by mammals are produced in the larynx, and are then filtered by the vocal tract before being emitted through the nostrils and lips. The air stream produced by the lungs provides the energy to put in vibration the vocal folds (the "source"), thus producing a sound. This sound then travels through the supra-laryngeal vocal tract (the "filter"), where its spectrum is modified. The rate of oscillation of the source is responsible for the pitch of the sound, *i.e.*, for its fundamental frequency (F0). The resonances of the vocal tract act as a band-pass filter applied to the original sound, selectively "amplifying" some frequencies by damping others, thus producing what are known as formant frequencies or *formants*, *i.e.*, frequencies that are "reinforced" by the resonance of the vocal tract (Fitch, 1994; Fry, 1979; Miller and Murray, 1995). Formants are not related to the fundamental frequency of vibration of the source, and can vary independently from it during vocal production (Fitch, 2000; Fry, 1979). Therefore, both

source related acoustic features and filter related ones can give information about the phenotype of the emitter, in an almost independent manner.

The fundamental frequency depends directly on the mass, length and tension of the source vibrating structure, *i.e.*, the vocal folds in mammals. An increase in the mass and length of the vocal folds produces a decrease in F0, while an increase in the tension produces an increase in F0. In humans, and in mammals at large, these three aspects of the vocal folds can be modified over a considerable range by the action of the laryngeal muscles. Therefore, the same individual can easily change the fundamental frequency of the sounds produced (Fry, 1979; Rendall et al., 2005). This lack of a strict relationship between body size and vocal folds makes the F0 a rather unlikely candidate to give reliable information about the size of the emitter in mammal species (Fry, 1979; McComb, 1991; Reby and McComb, 2003). On the contrary, formants are constrained by the length of the vocal tract. Formants and their spacing (*i.e.*, the *formant dispersion*) decrease with increase in vocal tract length (Fitch, 1997; Fry, 1979). The human vocal tract can be modelled as a uniform tube closed at one end (the glottis) and opened at the other end (the mouth), and this same model has been successfully applied to other mammal species as well (Fischer et al., 2004; Fitch, 1997; Fitch, 2000; Reby and McComb, 2003). In this model, formants and the vocal tract length are structurally related and it is, therefore, possible to calculate the formants that should be produced by a certain vocal tract length, as well as estimating the vocal tract length from the observed formant frequencies. This structural relationship is due to the fact that the vocal tract is bounded by the bones of the skull, which size is in turn closely related to body size. Therefore, the formants can convey reliable information about the size of the emitter (Fitch, 2000), and

are good candidates as an honest signalling system in mammal vocalizations (Fitch and Hauser, 2002).

Although the basic source-filter model is quite effective, and is very attractive due to its simplicity, many variations of the uniform tube model exist in real sound production systems. In all these cases, the fundamental frequency still depends on the source, and the energy distribution of the emitted signal on the resonances of the vocal tract, but the actual frequency structure of the sound might change from the expectations based on the uniform tube model. In the simplest scenario, the tube might be not uniform in section. In this case the average spacing of the formants should still be closely related to the vocal tract length, but the formants will not be equally spaced (Fischer et al., 2004). The situation becomes more complex when more than one resonator is present. In humans, and in mammals at large, the nasal cavities can contribute to vocal production (Fitch, 1994; Fry, 1979), depending on the position of the *velum*, a flap of tissue than can open or close the nasal passage. When the velum is lowered, the air can pass through the nasal cavity, which becomes a part of the sound emission tract and affects the filtering of the emitted sound. If two different resonators are present, there will be interference between them, leading to the production of anti-resonances (Fry, 1979). When the two resonators are in phase, the energy is amplified, producing higher peaks, whereas when they are out of phase, the energy is damped, producing deeper troughs in the amplitude spectrum (Fant, 1960). In this case, the interpretation of the sound structure is difficult, because it is not easy to discriminate between formant frequencies produced by each of the two resonators, or by their interaction (Chen, 1996).

The anatomy of the elephant seal vocal tract is poorly known (Murphy, 1914). Moreover, elephant seals have a very prominent proboscis, which is present only in males, and which shows an impressive development during growth (Laws, 1953; Chapter 3). Although the proboscis seems a typical secondary sexual trait (Darwin, 1871), the functional role of the proboscis, in particular in relation to male vocalizations, is uncertain (Sandegren, 1976). I recently showed (Chapter 3) that, in my study population, the male proboscis is under a positive sexual selection pressure, that likely depends on its effect on the vocalizations emitted during agonistic contests. Contrary to anecdotal statements found in the literature (*e.g.*, Sandegren 1976), it is not unreasonable at all to assume a role of the proboscis in elephant seal vocalizations because the nostrils are typically open and air is emitted through them during male elephant seals vocalizations, as it is possible to observe during particularly cold days (personal observation). In different mammal species that have been studied using cineradiographic methods (dogs, goats, pigs and cotton-top tamarins: Fitch 2000), loud calls seem to be characterized by a closure of the velum, hence closing off the nasal passages, but in some cases (dog whines and pig grunts: Fitch 2000) the vocalizations appear to be nasally emitted. The proboscis increases the length of the vocal tract and, hence, permits the production of sounds which can exaggerate the perceived size of the emitter (Fitch and Hauser, 2002). Due to its big size (average total length of the outline = 74 cm for adults, maximum of 94 cm; Chapter 3) the proboscis can be a very important secondary resonator, affecting the whole interpretation of the formant structure. The presence of two resonators makes the system very flexible, due to the possible tuning between the two, resulting in a much more varied combination of formants than in the presence of a single resonator (Chen, 1996). Due to the greater

length and smaller diameter of the nasal tract with respect to the oral tract, and due to the energy absorption properties of the nasal side branches and nasal turbinates (Fitch, 2000; Fry, 1979), I expect the presence of some very weak and low frequency formants, not explained by the oral tract resonances.

In this paper, I analyze the relationship between formants of vocalizations and individual phenotype in a large sample of southern elephant seal (*Mirounga leonina*) males of the Falkland Islands. I consider single structural aspects of the phenotype (size and age in particular), as well as global measures of the resource holding potential. I evaluate to what extent vocalizations in this species may convey reliable information on the emitter, and which acoustic features are better at performing this task. Finally, I present a simple, preliminary, model of sound production for the species.

VII.3 METHODS

Data were collected during 10 breeding seasons (September-November, 1995 to 2004) at Sea Lion Island (Falkland Islands; SLI hereafter), which shelters a small and localized population of southern elephant seals (Galimberti and Sanvito, 2001), comprising about 550 females and about 60 breeding males. All males were individually recognized, because they were tagged (with at least two tags per individual, Jumbo Rototag, Dalton ID Systems Ltd, www.dalton.co.uk) during previous breeding seasons, some of them at birth and the rest upon arrival on land during their first breeding season. All breeding males were also marked with large hair dye marks to permit fast and safe recognition

during each breeding season. More details on the marking protocol are available elsewhere (Galimberti and Boitani, 1999).

VII.3.1 Recording protocol and acoustic analysis

Recording of male agonistic vocalizations was carried out by standard stimulation of the animals, following the protocol described in Sanvito and Galimberti (2000a). I recorded vocalizations during the whole length of the breeding season. In all I obtained recordings for 251 males (418 males/year), with some males recorded over different seasons (1 to 6; mean = 1.7 ± 1.1). I used portable digital recorders (DAT TCD-D100, Sony Inc.) and dynamic cardioid microphones (MD 441, Sennheiser), with a frequency response of 30-20000 Hz. Sound were recorded at 48 KHz sampling frequency and with 16 bit resolution, and digitally transferred to a computer for analysis. Sound measurement and spectral analysis were carried out using various computer programs, including Canary 1.2 (v. 1.2; Macaulay Library, Cornell Laboratory of Ornithology, Ithaca, New York; <http://www.birds.cornell.edu/brp/SoundSoftware.html>), procedures written in Igor Pro 4.0.9 (WaveMetrics Inc, www.wavemetrics.com), and custom programs written in Revolution 2.0 scripting language (Runtime Revolution Ltd, www.runrev.com). I used the following settings for spectral analysis (Charif et al., 1995): Hamming window function with frame length of 21.33 ms (1024 pts) and corresponding filter bandwidth of 190.31 Hz; frames overlap of 50% with a time grid resolution of 10.67 ms; frequency grid resolution of 11.72 Hz (FFT = 4096 pts).

I measured 8 frequency variables (see also Chapter 5 for details). Fundamental frequency (F0, Hz) was calculated from the waveform in the predominant "part" of the

bout (longer/more intense syllable portion characterized by constant pulse rate, Chapter 5), as the pulse rate in that part (Zuberbuhler et al., 1997). All the other variables were related to formants, which are parts of the frequency spectrum that are “reinforced” by resonant properties of the vocal tract (Miller and Murray, 1995), and have been measured on the pulsing bout average power spectrum (see Figure 1 Chapter 5): the first 5 formant frequencies, called formants for brevity (F1 to F5, hereafter; Hz); formants dispersion, as the average spacing between consecutive formants (Hz), which has been proposed in recent works as a good synthetic indicator of vocal tract length and body size, (Fitch, 1997); minor formant (Hz), which was the very first peak in the power spectrum, at lower frequency and reduced intensity with respect to F1 and just preceding it. Its frequency was often below 100 Hz. I calculated year specific male average values, for each of the acoustic variables considered. Additional details on the recording and acoustic analysis protocol can be found elsewhere (Sanvito and Galimberti, 2000a; Chapter 5).

I calculated formant dispersion as the average spacing between consecutive formants, instead of using the method proposed by Reby and McComb (2003), because the latter assumes the vocal tract to be well modelled by a uniform tube, an assumption that I am not able to make for elephant seals.

VII.3.2 Age estimation

Age was known for males tagged as pups, and estimated with 1 year precision for the other males using external morphology (Clinton, 1994; Galimberti and Boitani, 1999; Chapter 5). Mean intra-observer reliability in age classification using morphology was 0.95, and inter-observer reliability ranged from 0.93 to 0.99 for two to four observers.

Congruence of the whole classification was checked using lifetime records of the males that were present three or more breeding seasons, and comparing age category to actual age for males tagged at birth. In the analysis where age is involved, I only used males for which I either knew the true age or which have been followed for a number of seasons sufficient to obtain a reliable estimate of age from morphology. In all, I knew the age of a total of 188 males (355 males/year). For a sample of 91 males (126 males/year) I had full information on all the acoustic features, age, body size and behavioural performance.

VII.3.3 Body size estimation

Body length was estimated using a photogrammetric method (Bell et al., 1997; Haley et al., 1991) that permits the measurement of size without restraint of the animal, and with low disturbance. I took pictures of the side of the animal, lying straight on a flat sand surface, with a telescopic 4-m long (1 cm increments) surveying pole (Model 406 BIS/D – Salmoiraghi Strumenti Spa, Milano, Italy - <http://www.salmoiraghistrumenti.it>) held horizontally on the back of the animal. Pictures were then measured using the Object Image software, available at no cost from the author web site (<http://simon.bio.uva.nl/object-image.html>), using the pole as scale. More details on the application of the methods, including measurement error and repeatability, are available elsewhere (Galimberti et al., submitted).

VII.3.4 Proboscis traits measurements

I applied a similar photogrammetric method for the measurement of the proboscis size and shape. An operator held a 2-m segment of the same surveying pole described above

right in front of the animal, and elicited the adoption of a head up posture, verifying the alignment of the middle of the muzzle with the pole. A second operator took pictures from the side, with the pole included in the frame to be used as scale, at a distance of 2-3 m, adjusting the position of the camera as the animal moved, in order to achieve the best alignment. Pictures were then measured using the same software used for body size measurement. More details on the application of the methods, including measurement error and repeatability, are available elsewhere (Chapter 3).

In this paper I considered 3 different proboscis measurements: trunk length (the total maximum linear length of the trunk), and first and second bump outlines (the curvilinear length of the two bumps composing the proboscis, respectively; see Figure 2 of Chapter 3). I collected data on facial morphology during 1996 and 2002 breeding season only, for a total of 66 males.

VII.3.5 Behavioural observation and agonistic activity index

Social behaviour was observed during standard observation periods of two-hour length. During observation periods, agonistic interactions were observed using an all-occurrences sampling norm and a continuous recording norm (Altmann, 1974). For all interactions, identity of both males and of the winner was recorded. For each male I calculated an agonistic activity index, given by the mean number of interactions begun by the male over the observation periods in which the male was observed (although I tried to balance the number of observation periods, different males were in fact observed for a different number of periods). Only males observed for at least 20 periods were included in the behavioural analysis. From the serial records of agonistic interaction results, I built dyadic

interaction matrices, used to calculate a competition success index (see below). More details on the observation protocol are available elsewhere (Galimberti et al., 2003).

VII.3.6 Resource holding potential

The resource holding potential (RHP) is the capability of an individual to compete for a resource (Maynard Smith and Parker, 1976), females in the case of male elephant seals. RHP is difficult to estimate, because it depends on a large suite of structural and behavioural traits (Braschi, 2004; Galimberti, 1995; Haley, 1994). Some of these traits can be readily measured (*e.g.*, age and size), but others are more difficult or impossible to measure in the field (*e.g.*, motivation and personality). Moreover, RHP is a relative measure and depends on the distribution of phenotypic traits of the other males. Therefore, I used success in competition as a proxy for the suite of latent, often not measurable, traits that globally constitute RHP. I used the David's dominance score (DS, hereafter; Gammell et al., 2003) to measure competition success. Yearly scores were calculated from dyadic agonistic interaction matrices, and then converted to relative scores ranging from 0 (minimum David's score) to 1 (maximum David's score) to permit comparison among years. I estimated this index for 191 males (298 males/year).

To have another, more conventional measure of RHP, I ran a principal component analysis on the correlation matrix of the male traits (body length, age and agonistic activity index). The first component explained 80% of the variance of the three original variables. I calculated the scores of observations for this first component using a regression method, and used the scores as a summary measure of RHP (RHP index, hereafter).

VII.3.7 Vocal tract estimation

I first estimated the expected oral and nasal tracts from the observed formants, and then estimated these same measures from the observed external morphology of the males, in order to compare the two figures obtained.

VII.3.7.1 Expected vocal tract length from the formant frequencies

I approximated the vocal tract with a uniform tube, closed at one end (the glottis) and opened at the other end (either the mouth or the nostrils, depending on the path modelled). I calculated vocal tract length as:

$$VTL = ((2i-1)*c)/(4*F_i)$$

where F_i are the formant frequencies, c is the velocity of sound in air (approximated at 350 m/s) and VTL is the vocal tract length (modified from Reby and McComb, 2003). I calculated the expected oral tract length from F_5 , since upper formants should be in theory better related to vocal tract length than lower ones, and the expected nasal tract length from the minor formant, which is the only formant that is luckily to be produced nasally and that can be seen on the power spectrum (other nasally emitted formants should be masked by the more powerful orally emitted ones).

VII.3.7.2 Expected formant frequencies from the external morphology

Detailed descriptions of the fine anatomy of the larynx of elephant seals are available (Dong et al., 1993; Schneider, 1964), but there is no information on the actual position of the larynx, the length of the vocal tract, or its shape. Moreover, the autopsic description of specimens is probably not representative of the real vocal tract length during vocalizations (Fitch, 2000). The larynx, and vocal tract in general, are not completely

static structures, and they can be moved over a certain range. Humans are characterized by a "descended larynx", *i.e.*, a larynx that descends during puberty and rests at the back of the throat. It was believed to be peculiar to human beings, and it is an important prerequisite for the evolution of human speech. Recently, it has been discovered that other non human mammals have a descended larynx (chimpanzees; Nishimura et al., 2003; roaring cats: Pocock 1916; koalas: Sonntag 1921; deer: Fitch and Reby 2001). Cineradiographic studies has shown that the larynx is a dynamic structure, being lowered in the vocal tract during sound emission, and coming back to its resting position otherwise (dogs, pigs, goat, monkeys: Fitch 2000).

Elephant seal vocalizations are made up of pulse trains, and they are very rhythmic. In most cases it is possible to observe a "bump" in the male chest, moving back and forth rhythmically during vocal emission (Figure VII.1), likely corresponding to the larynx movements, similarly to what have been demonstrated using cineradiography in deer (Fitch and Reby, 2001). I used the position of this bump to obtain approximate estimate of vocal tract length for 16 adult males for which I had picture series clearly showing the movements of this bump. Measurements were carried out using the same photogrammetric methodology described above. I calculated an approximate path of air emission during vocalizations, both through the mouth (oral tract, from the larynx, to the throat and the lips) and through the nostrils (nasal tract, from the larynx, through the throat, the nasal passages and out from the nostrils; Figure VII.2). These estimates are approximate, but they should give a realistic range of variation of the vocal tract length in elephant seals, to be compared with the estimates obtained from the formants of the acoustic output.

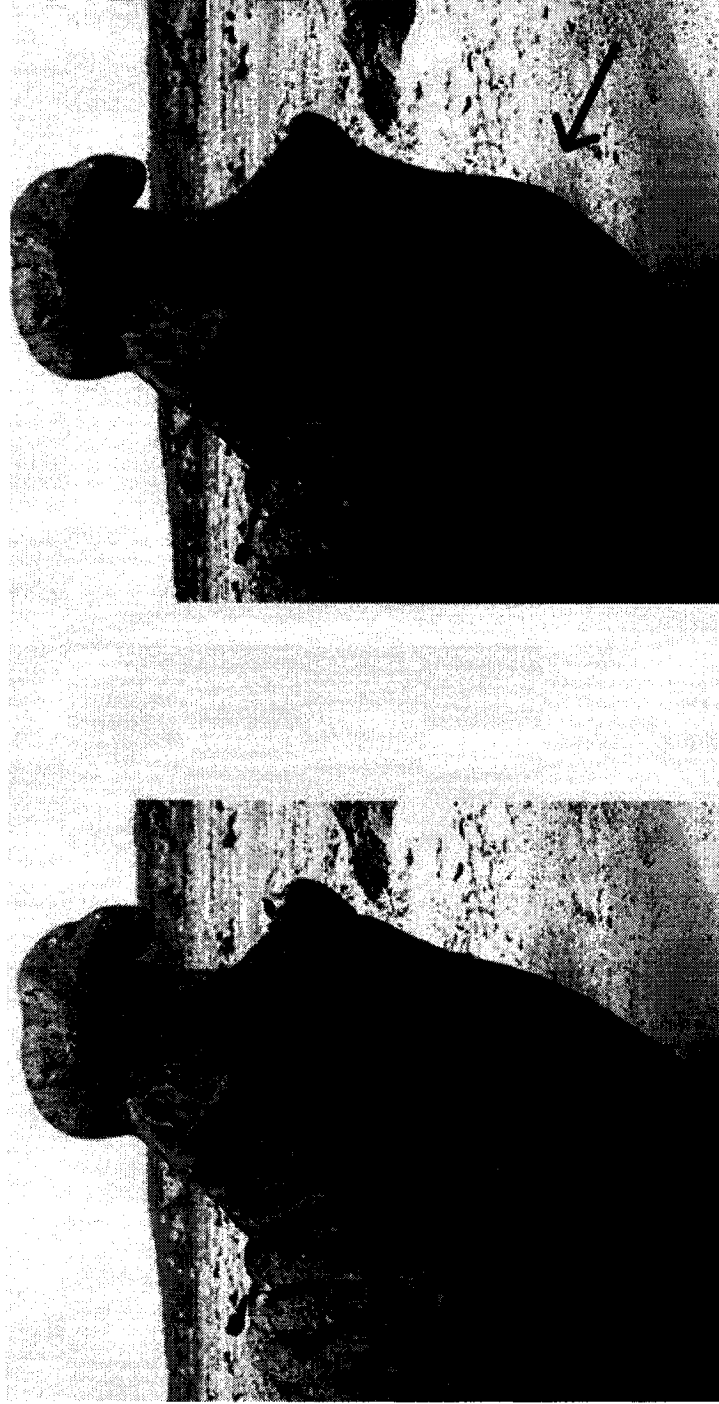

Figure VII.1 - Elephant seal male during vocalization. Left: just before the beginning of the vocalization; Right: during the actual vocalization. The arrow indicates the likely position of the larynx (bump in the throat moves rhythmically during the vocal emission).

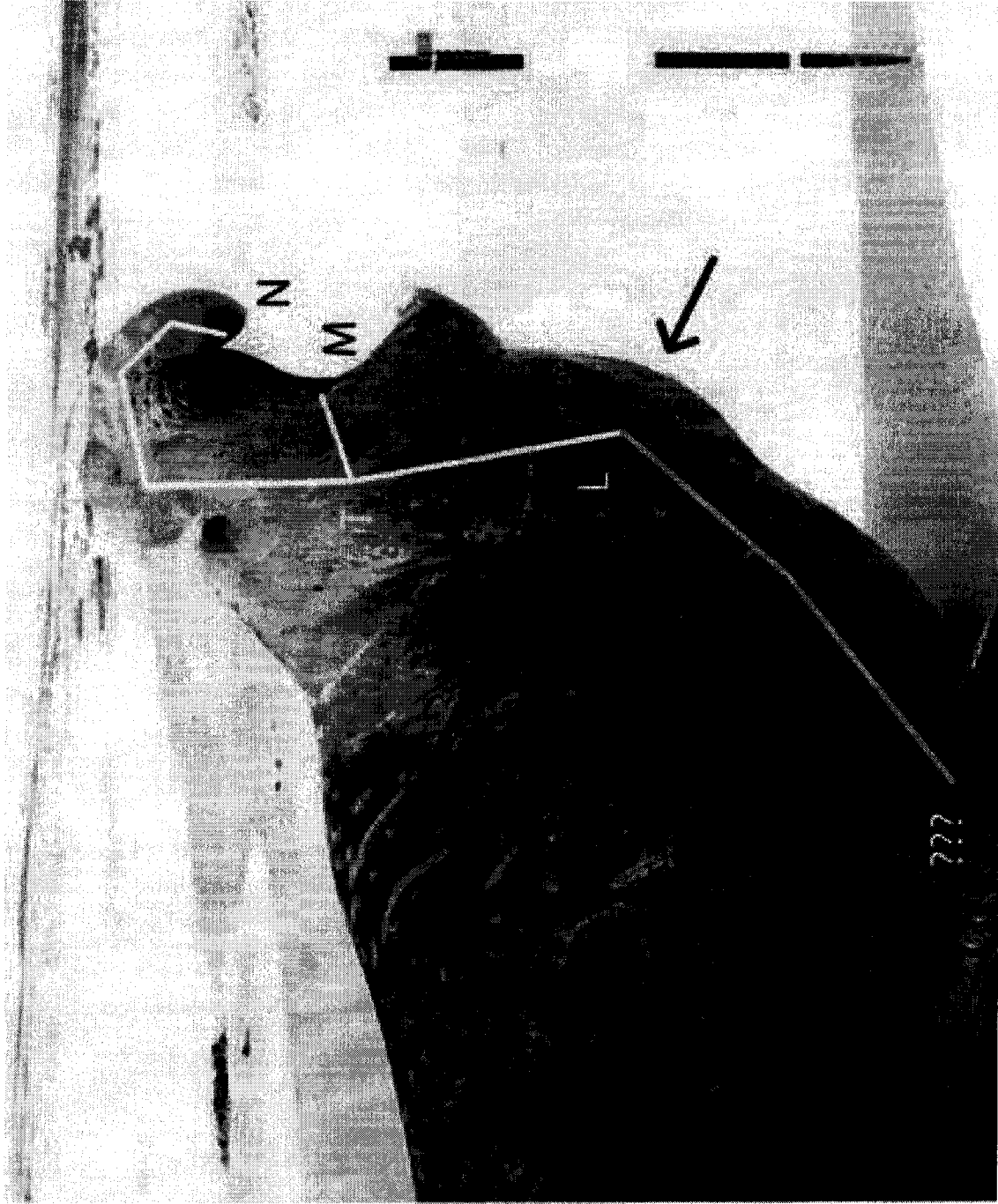

Figure VII.2 - Vocal tract measurement during vocalization. Path L-T-M: oral tract; Path L-T-N: nasal tract. The arrow indicates the likely position of the larynx. The grey line indicates an hypothetical vocal tract estimated, using the uniform tube model, from the minor formant and assuming it is produced by an oral only tract (no nasal tract).

VII.3.8 Statistics

Statistics are presented as mean \pm standard deviations. To explore the relationships between frequency features of vocalization and phenotype I: 1) made scatterplots with LOWESS smoothers (Trexler and Travis, 1993) of each phenotypic trait versus each formant feature and, 2) I ran univariate OLS regressions of each phenotypic trait versus each frequency feature. Scatterplots showed no sign of non-linear relationships between phenotype and frequency features in most cases, therefore I used only linear models in the following analysis. I calculated the coefficient of determination (*i.e.*, the proportion of the phenotypic trait variance explained by the linear relationship with the frequency feature) as a summary measure of the capability of frequency features to convey information about phenotype. To assess the importance of different frequency features I ran stepwisw multiple regressions of each phenotypic trait and RHP versus the whole set of features. I then ran mixed effect regressions with the frequency features retained by the stepwise procedure, to cope with the longitudinal structure of my data set (multiple measures of the same male in different years). A Lagrange multiplier test was used to assess the significance of the random effect. Plain regression was used for analysis involving the proboscis traits, because this data set was not longitudinal. I calculated standard error of the regression coefficients using a jackknife delete-one procedure and I tested the significance of their difference from 0 using a randomization test with 10000 re-samplings (Manly, 1991). I compared the regressors of multivariate models using the standardized coefficients (betas; Rawlings, 1988). I checked the multi-collinearity of regressors by calculating the variance inflation factor, $VIF = 1/(1-R^2_j)$, where R^2_j is the coefficient of determination of the linear regression of a the regressor j versus all other

regressors included in the regression model. A VIF > 10 indicates a serious multicollinearity problem (Rawlings, 1988). I checked normality (Shapiro-Wilk test) and homoskedasticity (White test) of the each regression model residuals. All statistical analyses were run in Stata version 9 (Stata Corporation Inc, www.stata.com).

VII.4 RESULTS

VII.4.1 Correlation among acoustic features and among phenotypic traits

I analyzed the correlation structure of the frequency features and of the phenotypic traits using covariance/correlation matrices (Table VII.1). Many correlations between the frequency features were high and significant, in particular the ones between the five formants and formant dispersion. The only uncorrelated variables were the fundamental frequency and the minor formant. The Bartlett test of sphericity was significant ($\chi^2 = 5723.4$, $df = 28$. $P < 0.0001$). For the phenotype, I considered age, body length, agonistic activity, trunk length and DS dominance index. All the variables were strongly and significantly correlated. The strongest correlations were found between age and body length, and between the DS dominance index and all the other traits. The Bartlett test of sphericity was significant ($\chi^2 = 192.5$, $df = 10$. $P < 0.0001$).

VII.4.2 Frequency features and phenotypic traits

VII.4.2.1 Age

I found a significant negative relationship between age and each formant (Table VII.2), but the proportions of variance in age explained by the relationship with formants was

Table VII.1 - Covariance and correlation matrix for frequency features (A) and phenotypic traits (B). Covariances above the diagonal, Pearson's *r* below and variance on the diagonal. All correlations were significant at $P < 0.01$ (after sequential Bonferroni correction), except the correlation between minor formant and F0, which was not significant.

A)	F1	F2	F3	F4	F5	Min formant	F0	Formant dispersion
F1	2224	3607	5124	6314	6536	339	123	1077
F2	0.571	17959	20351	23214	25217	587	257	5402
F3	0.521	0.728	43501	48891	52086	1310	549	11740
F4	0.495	0.640	0.866	73295	77795	1711	576	17869
F5	0.433	0.588	0.780	0.898	102378	2101	652	23961
Minor formant	0.300	0.183	0.263	0.264	0.275	572	13	440
F0	0.306	0.225	0.309	0.250	0.239	0.066	73	132
Formant dispersion	0.302	0.533	0.744	0.873	0.990	0.243	0.205	5722

B)	Age	Body length	Trunk length	Agonistic activity index	DS
Age	4.3	48.0	3.9	1.5	233.8
Body length	0.824	838.9	64.4	28.9	3425.9
Trunk length	0.544	0.595	18.1	3.5	365.1
Agonistic activity index	0.591	0.635	0.559	1.7	151.1
DS	0.767	0.758	0.676	0.698	25762.4

Table VII.2 - Simple linear regressions of phenotypic traits vs frequency features All the models are fitted with male identity as random effect. N = number of males; R² = coefficient of determination; b = regression coefficient; se(b) = standard error of the regression coefficient calculated with a jackknife delete-one procedure; 95% CI(b) = 95% confidence interval of the regression coefficient calculated as above; P_{10k} = significance of the regression coefficient calculated with randomization; P = probability of the Breush-Pagan test on the significance of the random effect (*i.e.*, the male identities). * = significant at alpha = 0.05 (sequential Bonferroni correction, Holm method).

Age							
Acoustic parameter	N	R ²	b	se(b)	95%CI(b)	P _{10k}	P
Fundamental frequency	148	0.05	-0.020	0.02	-0.0594;0.0199	0.1080	0.0001*
Minor formant	126	0.10	-0.013	0.006	-0.0255;-0.0014	0.0063*	0.0001*
F1	148	0.04	-0.010	0.005	-0.0191;-0.0005	0.0296	0.0001*
F2	148	0.11	-0.003	0.001	-0.0058;-0.0011	0.0015*	0.0001*
F3	148	0.22	-0.005	0.001	-0.0061;-0.0036	0.0001*	0.0001*
F4	148	0.23	-0.004	0.001	-0.0046;-0.0026	0.0001*	0.0001*
F5	148	0.29	-0.004	0.001	-0.0043;-0.0029	0.0001*	0.0001*
Formant dispersion	148	0.28	-0.015	0.001	-0.0178;-0.0119	0.0001*	0.0001*
Body length							
Fundamental frequency	148	0.03	-0.044	0.337	-0.7096;0.6226	0.3753	0.0001*
Minor formant	126	0.10	-0.264	0.118	-0.4985;-0.0295	0.0027*	0.0174*
F1	148	0.10	-0.260	0.080	-0.4183;-0.1021	0.0002*	0.0001*
F2	148	0.16	-0.073	0.022	-0.1174;-0.0293	0.0001*	0.0001*
F3	148	0.32	-0.096	0.010	-0.1154;-0.0765	0.0001*	0.0001*
F4	148	0.35	-0.074	0.008	-0.0909;-0.0579	0.0001*	0.0001*
F5	148	0.37	-0.070	0.007	-0.0834;-0.0564	0.0001*	0.0001*
Formant dispersion	148	0.35	-0.280	0.028	-0.336;-0.2237	0.0001*	0.0001*
Agonistic activity							
Fundamental frequency	146	0.06	-0.04671	0.01128	-0.06901;-0.02442	0.0053*	0.4127
Minor formant	124	0.07	-0.01573	0.00471	-0.02506;-0.0064	0.0045*	0.7981
F1	146	0.05	-0.01006	0.00247	-0.01494;-0.00519	0.0085*	0.6151
F2	146	0.09	-0.00379	0.00088	-0.00552;-0.00206	0.0005*	0.8875
F3	146	0.15	-0.00338	0.00072	-0.00481;-0.00195	0.0001*	0.7673
F4	146	0.12	-0.00232	0.00047	-0.00325;-0.00139	0.0001*	0.8120
F5	146	0.13	-0.00202	0.00037	-0.00274;-0.00129	0.0001*	0.7359
Formant dispersion	146	0.13	-0.00815	0.00153	-0.01118;-0.00512	0.0001*	0.7773

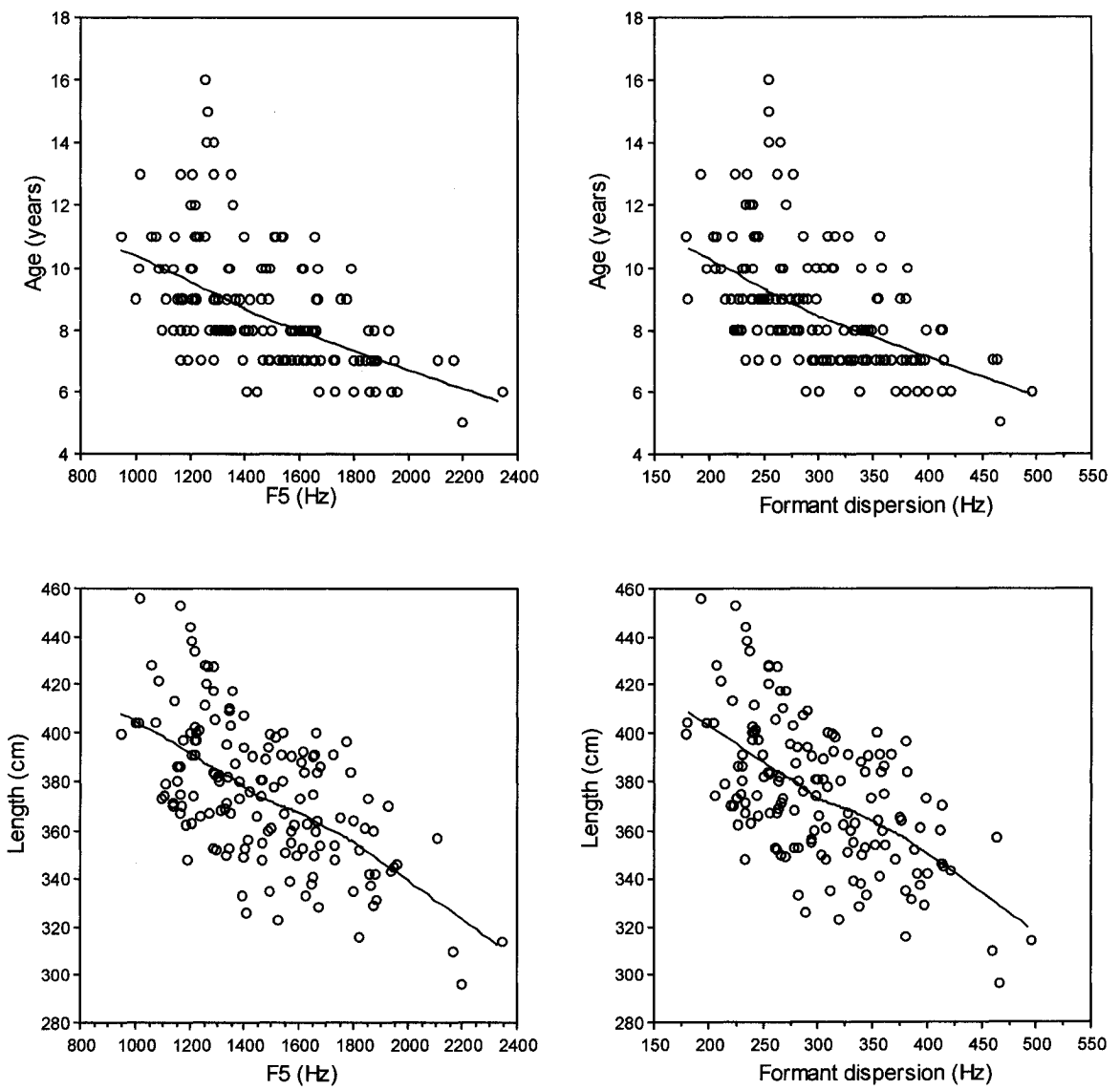

Figure VII.3 - Variation of age and length with the F5 and formant dispersion. The fitted lines are LOWESS smoothers. Points are individual males/year.

rather low, due to high dispersion of the data. The strength of the relationship was highest for the highest formant ($R^2 = 0.29$ for F5), while decreased going towards lower formants ($R^2 = 0.04$ for F1 and 0.10 for the minor formant). Formant dispersion was almost as good as F5 in predicting age ($R^2 = 0.28$; Figure VII.3). There was no significant relationship between age and the fundamental frequency.

A stepwise multiple regression of age versus all the acoustic features retained only F5 and the minor formant. The variance in age explained by this model was just slightly higher than the simple regression with F5 or formant dispersion alone ($R^2 = 0.30$ vs 0.29 and 0.28 respectively). The comparison of betas between the two retained variables showed that F5 was the most important regressor (beta = -0.47 vs -.017). A Lagrange multiplier test showed that the variance component due to the within individual effect (the male's identity) was significant for all the univariate tests performed but F1, the minor formant and F0 (Table VII.2), and for the final multiple regression model.

VII.4.2.2 Body length

There was an inverse relationship between body length and formants, while no relationship was found for F0 (Table VII.2). The last formant and the formant dispersion explained between 35 and 37% of the variance in body length (Figure VII.3), while the percentage decreased for lower formants with a minimum of 10% for F1 and the minor formant. The linear regressions of body length versus acoustic features were significant ($p < 0.05$) for all the formants, but not for the fundamental frequency.

A stepwise multiple regression of body length versus all the frequency features retained only F5, F2 and the minor formant. These frequency features together explained

a rather large percentage (40%) of the variance of the body length. F5 had the strongest relationship with body length, while the minor formant and F2 had a smaller and similar effect (beta: F5 = -0.47; minor formant = -0.18; F2 = -0.17). The variance components due to within individual effect were significant for all the univariate tests performed apart from F1 and the minor formant (Table VII.2) and for the multivariate test.

VII.4.2.3 Agonistic activity

The agonistic activity index decreased linearly and significantly with the increase of all frequency variables, but the proportion of variance explained was always quite small (maximum 15%; Table VII.2). Only fundamental frequency and F5 were retained in a stepwise multiple regression model ($R^2 = 0.17$). F5 had the strongest effect on the agonistic index (beta: -0.33 vs -0.19). The effect of the within individual component on the regression was not significant in any case (both simple and multiple regressions).

VII.4.3 Frequency features and resource holding potential

There was a significant inverse relationship between David's dominance score (DS) and each frequency feature (Table VII.3). The percentage of variance of DS explained by the frequency features was very low for the fundamental frequency and the lower formants, while it was more than 20% for the higher formants (F4 and F5) and the formant dispersion (Table VII.3; Figure VII.4). F5 explained 23% of variance in DS, and the visual inspection of LOWESS on the scattergram showed a sign of a bending in the relationship, with a reduction in slope, around 1700 Hz (Figure VII.4). I ran a stepwise

multiple regression of DS versus all the acoustic features, and only F5 was retained in the model .

The RHP index decreased linearly and significantly with increase in all the frequency features, and the strength of the relationship increased from the lower to the higher formants (R^2 from 0.08 to 0.33; Table VII.3; Figure VII.4). The relationship with the fundamental frequency was also significant, but the R^2 was very low. The fifth formant, together with the minor formant and the fundamental frequency, were retained in a stepwise multiple regression analysis, which altogether explained 38% of the variance in the RHP index. The effect of F5 was greater than the other two variables (beta: F5 = -0.48; minor formant = -0.19; F0 = -0.15). The variance components due to within individual effect were significant for all the univariate tests performed but minor formant and were not significant for the multivariate test.

VII.4.4 A model for elephant seal vocal tract

VII.4.4.1 Relationship among minor formant and phenotype

The minor formant is a particularly low formant, found at very low frequencies of male vocalizations power spectra and, hence, it is a good candidate as a nasal resonance.

In order to determine which frequency feature of the vocalization could be affected by the size of the trunk, I preliminary ran a multiple regression of trunk length with all the frequency features. The only variable that was significantly related to trunk length was the minor formant (beta = -0.3151; $P_{10k} = 0.0322$), while all the other were not ($P_{10k} > 0.34$ in all cases).

Table VII.3 - Simple linear regression analysis of competition success (David's dominance score) and RHP indexes versus frequency features. All the models are fitted with male identity as random effect. See Table VII.1 for label definitions.

Competition success	N	R ²	b	se(b)	95%CI(b)	P _{10k}	P
Fundamental frequency	297	0.03	-0.00561	0.00155	-0.00866;-0.00256	0.0016*	0.0001*
Minor formant	264	0.04	-0.00175	0.00059	-0.00292;-0.00058	0.0023*	0.0001*
F1	298	0.05	-0.00122	0.00031	-0.00183;-0.00062	0.0002*	0.0001*
F2	298	0.09	-0.00060	0.00011	-0.00081;-0.00039	0.0001*	0.0001*
F3	297	0.18	-0.00058	0.00007	-0.00071;-0.00045	0.0001*	0.0001*
F4	298	0.20	-0.00045	0.00005	-0.00055;-0.00036	0.0001*	0.0001*
F5	298	0.23	-0.00040	0.00004	-0.00048;-0.00033	0.0001*	0.0001*
Formant dispersion	298	0.21	-0.00163	0.00016	-0.00195;-0.00131	0.0001*	0.0001*
RHP							
Fundamental frequency	146	0.06	-0.02771	0.00748	-0.04248;-0.01293	0.0050	0.0001*
Minor formant	124	0.12	-0.01110	0.00374	-0.01851;-0.00369	0.0001*	0.0534
F1	146	0.08	-0.00767	0.00215	-0.01193;-0.00342	0.0020*	0.0001*
F2	146	0.14	-0.00275	0.00053	-0.00381;-0.00170	0.0001*	0.0001*
F3	146	0.28	-0.00302	0.00036	-0.00372;-0.00232	0.0001*	0.0001*
F4	146	0.28	-0.00227	0.00026	-0.00279;-0.00175	0.0001*	0.0001*
F5	146	0.33	-0.00203	0.00020	-0.00242;-0.00164	0.0001*	0.0001*
Formant dispersion	146	0.32	-0.00827	0.00085	-0.00995;-0.00660	0.0001*	0.0001*

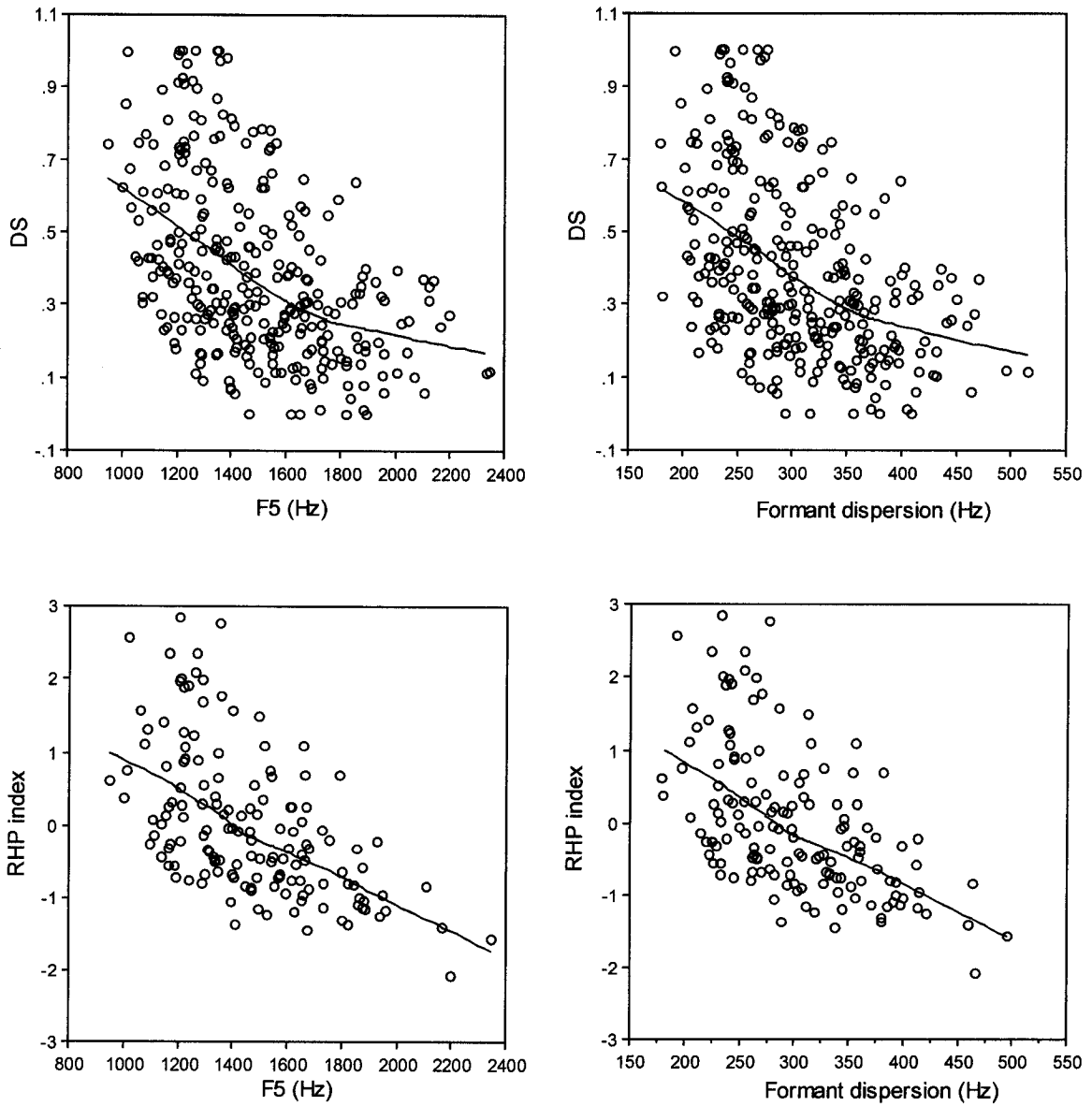

Figure VII.4 - Variation of competition success and RHP index with the F5 and formant dispersion. The fitted lines are LOWESS smoothers. Points are individual males/year.

To determine which characteristic of the male phenotype more strongly affected the emission of this particular formant, I ran a multiple regression of minor formant with different phenotypic traits. I considered age, body length and three measures of proboscis size (linear length, first bump outline, second bumps outline). These variables were strongly correlated (Table VII.4), but not so much as to produce a significant problem of multi-collinearity (maximum VIF = 5.14). The model explained 28% of the variance in minor formant, and the only variable that significantly affected the change in minor formant was the trunk length (Figure VII.5), followed by the second bump outline, which was anyway not significant (Table VII.4).

VII.4.4.2 Vocal tract model

I used the uniform tube model open at one end and closed at the other end (see Methods) to estimate the vocal tract length of elephant seals expected from average values of formant frequencies measured in adult males. Higher formants are in theory better indicators of vocal tract length, since they are less affected by the shape of the upper vocal tract (mouth, tongue, etc, Fry, 1979). Moreover, they are the best index of body size (see previous Results section). Therefore, I used F5 to calculate my first vocal tract length estimate, assuming F5 to be produced orally. I also calculated a second estimate using the minor formant, assuming that this is the first formant produced by the elephant seal nasal tract (again modelled with the uniform tube). The results of these two models are shown in Table VII.5. The average F5 for adult males in my population was 1326 Hz, which leads to an average oral tract length for adults of 59 cm. The average minor formant for adults was 76 Hz, which leads to an average nasal tract of 115 cm.

Table VII.4 - Multiple regression of minor formant with phenotype features (age, body length, agonistic activity index, trunk length, first and second bump of the trunk outlines). N = number of males; R^2 = coefficient of determination; b = partial regression coefficient; beta = standardized partial regression coefficient; P_{10k} = significance of the regression coefficient calculated with randomization.; VIF = variance inflation factor, see Methods.

Minor formant (N = 47; $R^2 = 0.28$)				
Regressor	b	beta	P_{10k}	VIF
Age	-1.70620	-1.77372	0.3372	3.55
Body length	0.09564	0.10748	0.4457	4.64
Trunk length	-2.75754	0.96491	0.0049	5.14
1 st bump outline	0.55662	0.31213	0.1570	2.10
2 nd bump outline	0.66837	0.42412	0.0833	2.43

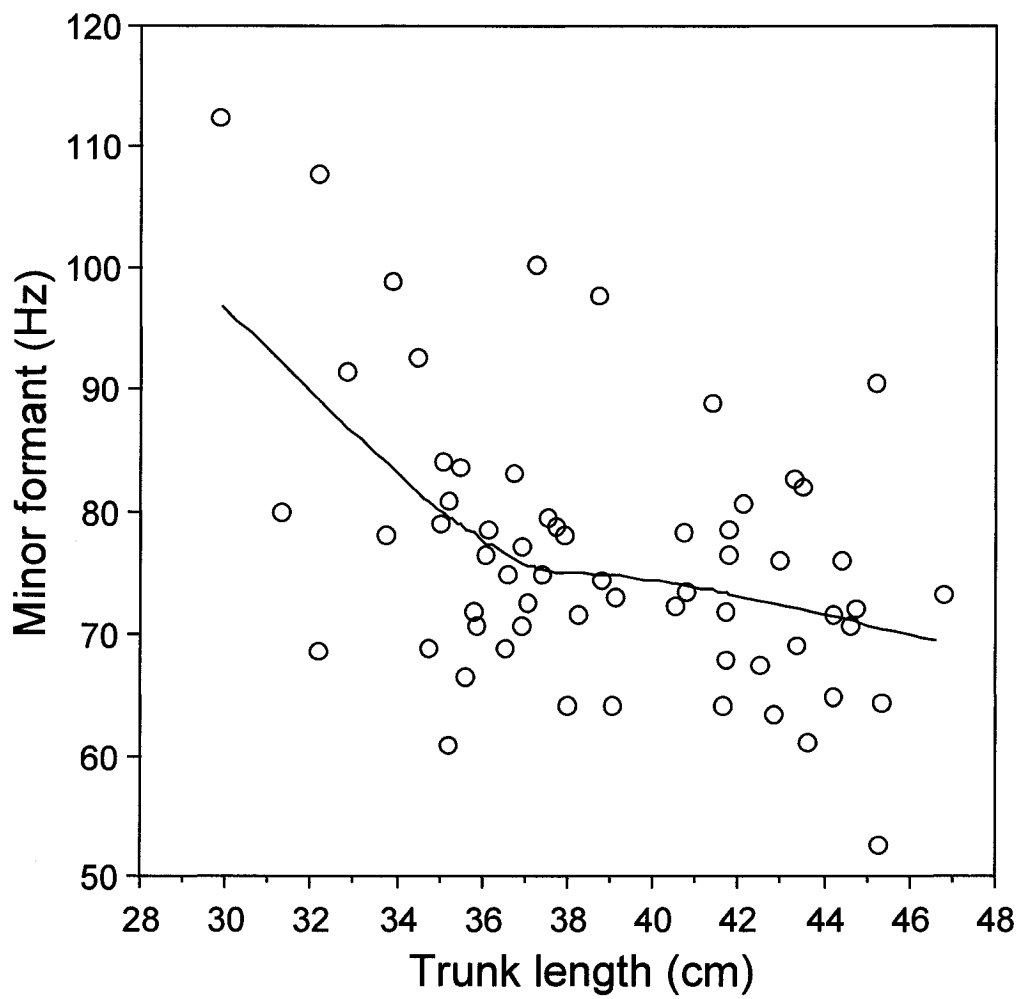

Figure VII.5 - Variation of minor formant with trunk length. The fitted line are LOWESS smoothers. Points are individual males/year.

I estimated an approximate vocal tract from external morphology from pictures of vocalizing males. On a sample of 32 pictures from 16 different adult males, the average oral only tract was 58 cm while the average total nasal tract was 114 cm (Table VII.5). These values are in very good agreement with the estimates obtained from formant frequencies with the model including the nasal tract.

VII.5 DISCUSSION

My results indicate that vocalizations of male southern elephant seals convey reliable information about the structural and behavioural phenotype of the emitter. Formants, and in particular the highest one I measured (F5), explain a significant proportion of the variance in age, size, and resource holding potential at large. Therefore, the information content of vocalizations can potentially be used to settle agonistic contests without the need for direct interactions and fights. On the contrary, fundamental frequency shows a weak relationship with phenotype, similarly to what has been found for humans and mammals at large (Fitch, 1997; Reby and McComb, 2003; Rendall et al., 2005). The main reason for this lack of relationship, at variance with the results from other taxa (Davies and Halliday, 1978; Morton, 1977; Ryan, 1980), is that the mammal vocal folds are not strongly constrained by the neighbouring bony structures and, therefore, their size and shape can be easily changed during sound emission (Fitch, 1997; Fitch and Hauser, 2002; Fry, 1979). Moreover, at least in humans and some primates, vocal folds ontogenetic development, and resulting F0 profiles, is at least partially dissociated from the more general growth program that affects true overall body size (Rendall et al., 2005).

Table VII.5 - Vocal tract estimation for adult male elephant seals. Mean and 95% confidence limits (CL) are presented (N = number of males). F5_VTL: length of a hypothetical vocal tract assuming F5 as the fifth formant produced by its resonances; Minor formant_VTL: length of an hypothetical vocal tract assuming the minor formant as the first formant produced by its resonances(see Results).

	N	Mean	95% lower CL	95% upper CL
F5 (Hz)	79	1326	1286	1366
F5_VTL (cm)	79	59	58	61
Minor formant (Hz)	70	76	72	80
Minor formant_VTL (cm)	70	115	109	122
Oral tract (cm)	16	58	55	61
Nasal tract (cm)	16	114	109	119

In elephant seals, the frequency features that convey more information about the phenotype are the highest formant (F5) and the minor formant. The formant dispersion, which has been proposed as the simplest summary measure of the resonance features of the vocal tract (Fitch, 1997), is a good index of the phenotype of the emitter, but not as good as F5. The amount of information carried by the other formants analyzed (F1 to F4) decreases gradually from higher towards lower ones, similarly to what has been found in red deer (Reby and McComb, 2003), although the structural correlation between the formants somehow hampers the discrimination of direct effects. The higher information content of upper formants with respect to lower ones is not surprising, since the lower formants are known to depend strongly on the shape of the supra-laryngeal vocal tract, which can be modified during sound emission. This is, for instance, the case in human speech: the same individual is able to emit very different sounds (*i.e.*, vowels) with very different spacing of the first three formants, by simply changing the shape and position of the components of the upper vocal tract (Fant, 1960; Fry, 1979; Reby and McComb, 2003). In particular, the change in the opening of the mouth can greatly affect the first formant (the more open the mouth, the more different from the uniform tube expectation is the F1, which increases proportionally), while F2 and F3 are mostly affected by the position of the tongue (Fry, 1979). On the contrary, higher formants are not greatly affected by the position of the jaw and the tongue, and are more related to the vocal tract length. Non-human mammals had been originally assumed to be less able to modify the formant structure with respect to humans, due to the lack of a descended larynx (Fitch and Reby, 2001; Negus, 1949) and to a lower capability of changing the supra-laryngeal vocal tract, but there are increasing evidences that these assumptions are not true (Fitch, 2000;

Fitch and Reby, 2001; Hauser et al., 1993; Hauser and Schön-Ybarra, 1994). Elephant seals usually vocalize with a rather open mouth (Chapter 3), but they are able to change their jaw posture during vocalizations. There is also some variation between individuals, with some males vocalizing with a rather closed mouth (unpublished data). Moreover, examination of close up videotapes showed that the position of the tongue is also rather variable: some males push the tongue all the way down to the bottom of the throat while others keep it close to the teeth. Given this capability of male elephant seals to change the configuration of the upper part of the vocal tract, it is not surprising that their higher oral formants are better predictors of structural phenotype than lower ones. For instance, the mean observed F1 of adult males is 258 Hz, while the expected F1 in a uniform tube should be F5/9, that is to say 147 Hz. By opening the mouth the elephant seals double the actual diameter of the tract with respect to the uniform tube model, greatly increasing the first formant value.

In elephant seals, the interpretation of the functional role of the vocalizations is particularly difficult because of the presence of the proboscis, which acts as a secondary resonator. My multivariate regression analysis indicated the minor formant as the second most important component of the vocalizations, after the F5, in conveying information about the emitter phenotype. The minor formant is related to the proboscis, and its strongest relationship with the phenotype is with the proboscis length. Therefore, the minor formant could be the result of the resonances due to the nasal passage. To produce the observed range of the minor formant, in fact, a hypothetical vocal tract made by the oral part only should be 115 cm long, which is unreasonable, because the position of the larynx would have to be unrealistically low in the body (Figure VII.2). On the contrary, if

I assume that the minor formant is produced nasally (by the air passing through the nasal cavity and out from the nostrils), the estimated tract length is well in accordance with the measures obtained from the lateral pictures of vocalizing elephant seals. This model of vocal production, with the sound originating in the larynx and being emitted both from the nostrils and lips, is also in accordance with an oral only tract length of about 60 cm, calculated from the observed F5. In conclusion, the presence of the minor formant, its position in the vocalization power spectrum, and its relative low amplitude with respect to the other formants, supports the idea that the nasal tract is in fact involved in male elephant seal vocalizations, representing an extension of the oral tract, contrary to all the anecdotal statements found in the literature (McCann, 1981; Sandegren, 1976). Vocal tract elongation is widespread in birds (tracheal elongation) and present also in some mammals (descended larynx, proboscises), and may exaggerate the size information conveyed by acoustic signals with respect to the true size (Fitch and Hauser, 2002).

Although my results confirm that formants may convey reliable information about the phenotype of the emitter and can be honest signals (Fitch and Hauser, 2002), they also show that the variance of phenotypic traits explained by the formants is rather low. The information content of the formants observed in elephant seals is in accordance with previous results in other species, which show that formants rarely explain more than 40% of the variance in phenotypic traits (Reby and McComb, 2003). Most authors consider these evidences as a final confirmation of the honest signal role of vocalizations, but I suggest that these low amount of variance explained should be considered with caution. Although the relationships between phenotypic traits and higher formants are often significant, what really matters is the capability of formants to give an effective base of

assessment for males involved in agonistic contests. The percentage in variance of phenotypic traits not explained by variation in the formants is in most cases more than 50%. Therefore, the effectiveness of an assessment system based on formants only is, at least, dubious. The low percentage of variance explained may be related to measurement error in formants, that may reduce the strength of the relationships, but it is rather unlikely for this effect to be so strong as to produce a very large decrease in the variance explained.

Many factors can reduce the capability of formants to convey information about the phenotype. Firstly, the elephant seals vocal system is complicated by the presence of two interacting resonators, and this may reduce the strength of the relationships and increase the measurement error of formant frequencies. Moreover, many different pressures can influence the growth of various bony structures of the skull and face, producing a development pattern rather independent from simple body growth (Rendall et al., 2005). Even in humans, for which the vocal tract anatomy is much better known, the relationship between the formants and phenotype is not always strong, (Rendall et al., 2005). Very strong correlations between formants and phenotype have been obtained for both humans and some other mammals (macaque and dogs) only when lumping together data from structurally different groups, such as sexes (Fitch, 1997; Rendall et al., 2005) or dog breeds (Riede and Fitch, 1999). On the contrary, much lower correlations were found, even in other species (red deer), when considering sexes separately (Reby and McComb, 2003; Rendall et al., 2005). Vocalizations are present in most elephant seal agonistic contests, and their use alone permits them to settle a large proportion of contests, but vocalizations are more effective when the RHP of the males is pretty

different, for example during confrontations between males of different age classes (Braschi, 2004). Therefore, the formants can be used to settle contests when there are gross differences between males. In these cases, even the rather low percentage of variance in phenotype explained by the formants may permit a reliable assessment of the opponent phenotype from vocalizations. In a previous study (Sanvito and Galimberti, 2003), I showed that the sound level of vocalizations is also a good index of rough differences in age and size, but is not very effective in discriminating males of the same age class. Vocalizations are only a part of the elephant seal display system, which also includes visual cues, and probably non-airborne acoustic signals (*e.g.*, seismic vibrations; Shipley et al., 1992). A full evaluation of the assessment system should include also these signals (Miller, 1991), a task that I are currently tackling.

VII.6 LITERATURE CITED

- Altmann J., 1974. Observational study of behaviour: sampling methods. *Behaviour*. **49**:227-267.
- Andersson M., 1994. *Sexual selection*. Princeton: Princeton University Press.
- Bartholomew G.A., Collias N.E., 1962. The role of vocalization in the social behaviour of the Northern Elephant Seal. *Animal Behaviour*. **10**:7-14.
- Bell C.M., Hindell M.A., Burton H.R., 1997. Estimation of body mass in the southern elephant seal, *Mirounga leonina*, by photogrammetry and morphometrics. *Marine Mammal Science*. **13**:669-682.
- Braschi C., 2004. Confronti agonistici nell'elefante marino del sud: fattori coinvolti e ruolo delle asimmetrie tra due maschi (Male agonistic behavior in southern elephant seals: factors and asymmetries involved in conflict) (PhD). Roma: Università La Sapienza di Roma.
- Charif R.A., Mitchell S., Clark C.W., 1995. *Canary 1.2 user's manual*. Ithaca, NY: Cornell Laboratory Of Ornithology.
- Chen M.Y., 1996. Acoustic correlates of nasality in speech. Illinois: Massachusetts Institute of Technology.
- Clinton W.L., 1994. Sexual selection and growth in male Northern Elephant Seals. In: *Elephant seals. Population ecology, behavior, and physiology* (Le Boeuf B.J., Laws R.M. eds). Berkeley (CA): University of California Press; 154-168.
- Clutton-Brock T.H., Albon S.D., 1979. The roaring of red deer and the evolution of honest advertisement. *Behaviour*. **69**:145-170.

- Darwin C., 1871. *The descent of man and selection in relation to sex*, 1 ed. London: John Murray.
- Davies N.B., Halliday T.R., 1978. Deep croaks and fighting assessment in toads *Bufo bufo*. *Nature*. **274**:683-685.
- Dong J., Wang G., Xiao Z., 1993. Morphological anatomy and measure of larynx of the southern elephant seal. *Marine Sciences/Haiyang Kexue*. **3**:48-51.
- Fant G., 1960. *Acoustic Theory of Speech Production*: Mouton, The Hague.
- Fischer J., Kitchen D., Seyfarth R., Cheney D., 2004. Baboon loud calls advertise male quality: acoustic features and their relation to rank, age, and exhaustion. *Behavioral Ecology and Sociobiology*. **56**:140-148.
- Fitch W.T., 1994. Vocal Tract Length Perception and the Evolution of Language (PhD): Brown University.
- Fitch W.T., 1997. Vocal tract length and formant frequency dispersion correlate with body size in rhesus macaques. *Journal of the Acoustical Society of America*. **102**:1213-1222.
- Fitch W.T., 2000. The Phonetic Potential of Nonhuman Vocal Tracts: Comparative Cineradiographic Observations of Vocalizing Animals. *Phonetica*. **57**:205-218.
- Fitch W.T., Hauser M.D., 2002. Unpacking "honesty": vertebrate vocal production and the evolution of acoustic signals. In: *Acoustic Communication* (Simmons A.M., Popper A.N., Fay R.R. eds). New York: Springer-Verlag.
- Fitch W.T., Reby D., 2001. The descended larynx is not uniquely human. *Proceedings of the Royal Society Biological Sciences Series B*. **268**:1669-1675.
- Fry D.B., 1979. *The physics of speech*: Cambridge Univ. Press.

- Galimberti F., 1995. Competizione tra i maschi e selezione sessuale nell' elefante marino del sud (*Mirounga leonina*) della Penisola di Valdés [Intermale competition and sexual selection in southern elephant seals (*Mirounga leonina*) of the Valdés Peninsula; in Italian, with English abstract] (PhD Thesis). Roma: Università degli Studi di Roma "La Sapienza".
- Galimberti F., Boitani L., 1999. Demography and breeding biology of a small, localized population of southern elephant seals (*Mirounga leonina*). *Marine Mammal Science*. **15**:159-178.
- Galimberti F., Fabiani A., Boitani L., 2003. Socio-spatial levels in linearity analysis of dominance hierarchies: a case study on elephant seals. *Journal of Ethology*. **21**:131-136.
- Galimberti F., Fabiani A., Sanvito S., 2002. Measures of breeding inequality: a case study in southern elephant seals. *Canadian Journal of Zoology*. **80**:1240-1249.
- Galimberti F., Sanvito S., 2001. Modelling females haul out in southern elephant seals (*Mirounga leonina*). *Aquatic Mammals*. **27**:92-104.
- Galimberti F., Sanvito S., Braschi C., Boitani L., submitted. The cost of success: reproductive effort in male southern elephant seals. *Behavioral Ecology and Sociobiology*.
- Gammell M.P., De Vries H., Jennings D.J., Carlin C.M., Hayden T.J., 2003. David's score: a more appropriate dominance ranking method than Clutton-Brock et al.'s index. *Animal Behaviour*. **66**:601-605.

- Haley M.P., 1994. Resource-holding power asymmetries, the prior residence effect, and reproductive payoffs in male northern elephant seal fights. *Behavioral Ecology and Sociobiology*. **34**:427-434.
- Haley M.P., Deutsch C.J., Le Boeuf B.J., 1991. A method for estimating mass of large pinnipeds. *Marine Mammal Science*. **7**:157-164.
- Harper D.G.C., 1991. Communication. In: *Behavioural ecology. III edition*. (Krebs J.R., Davies N.B. eds). Oxford: Blackwell; 374-397.
- Hauser M.D., Evans C.S., Marler P., 1993. The role of articulation in the production of rhesus monkey, *Macaca mulatta*, vocalizations. *Animal Behaviour*. **45**:423-433.
- Hauser M.D., Schön-Ybarra M., 1994. The role of lip configuration in monkey vocalizations: experiments using xylocaine as a nerve block. *Brain Lang*. **46**:232-244.
- Kitchen D.W., Seyfarth R.M., Fisher J., Cheney D.L., 2003. Loud calls as indicators of dominance in male baboons (*Papio cynocephalus ursinus*). *Behavioral Ecology and Sociobiology*. **53**:374-384.
- Laws R.M., 1953. The elephant seal (*Mirounga leonina* Linn.). I. Growth and age. *Scientific Reports of the Falkland Islands Dependencies Survey*. **8**:1-62.
- Laws R.M., 1956. The elephant seal (*Mirounga leonina* Linn.). II. General, social, and reproductive behaviour. *Scient. Rep. Falkland Is. Depend. Surv.* **13**:1-88.
- Le Boeuf B.J., Peterson R.S., 1969. Social status and mating activity in elephant seals. *Science*. **163**:91-93.
- Le Boeuf B.J., Petrinovich L.F., 1974. Elephant seals: interspecific comparisons of vocal and reproductive behavior. *Mammalia*. **38**:16-32.

- Manly B.F.J., 1991. *Randomization and Monte Carlo methods in biology*. London: Chapman and Hall.
- Maynard Smith J., Parker G.A., 1976. The logic of asymmetric contests. *Animal Behaviour*. **24**:159-175.
- McCann T.S., 1981. Aggression and sexual activity of male Southern elephant seals, *Mirounga leonina*. *Journal of Zoology London*. **195**:295-310.
- McComb K., 1991. Female choice for high roaring rates in red deer, *Cervus elaphus*. *Animal Behaviour*. **41**:79-88.
- Miller E.H., 1991. Communication in pinnipeds, with special reference to non-acoustic signalling. In: *The behaviour of the Pinnipeds* (Renouf D. ed). London: Chapman and Hall; 128-235.
- Miller E.H., Murray A.V., 1995. Structure, complexity, and organization of vocalizations in harp seals (*Phoca groenlandica*). In: *Sensory systems of aquatic mammals* (Kastelein R.A., Thomas J.A., Nachtigall P.E. eds). Woerden, The Netherlands: De Spil Publishers; 237-264.
- Morton E.S., 1977. On the occurrence and significance of motivation-structural rules in some bird and mammal sounds. *American Naturalist*. **111**:855-869.
- Murphy R.C., 1914. Notes on the sea elephant, *Mirounga leonina* (Linneo). *Bull. Am. Mus. Nat. Hist.* **33**:63-79.
- Negus V.E., 1949. *The comparative anatomy and physiology of the larynx*. New York: Hafner Publishing Company.

- Nishimura T., Mikami A., Suzuki J., Matsuzawa T., 2003. Descent of the larynx in chimpanzee infants. *Proceedings of the National Academy of Sciences of the U.S.A.* **100**:6930-6933.
- Pocock R.I., 1916. On the hyoidean apparatus of the lion (*P. leo*) and related species of Felidae. *Annual Magazine of Natural History.* **8**: 222-229.
- Rawlings J.O., 1988. *Applied regression analysis. A research tool.* London: Chapman and Hall.
- Reby D., McComb K., 2003. Anatomical constraints generate honesty: acoustic cues to age and weight in the roars of red deer stags. *Animal Behaviour.* **65**:519-530.
- Rendall D., Kollias S., Ney C., 2005. Pitch (F0) and formant profiles of human vowels and vowel-like baboon grunts: The role of vocalizer body size and voice-acoustic allometry. *Journal of the Acoustical Society of America.* **117**:944-955.
- Riede T., Fitch T., 1999. Vocal tract length and acoustics of vocalization in the domestic dog (*Canis familiaris*). *Journal of Experimental Biology.* **202**:2859-2867.
- Ryan M.J., 1980. Female mate choice in a Neotropical frog. *Science.* **209**:532-535.
- Sandegren F.E., 1976. Agonistic behavior in the male Northern Elephant seal. *Behaviour.* **57**:136-158.
- Sanvito S., Galimberti F., 2000a. Bioacoustics of southern elephant seals. I. Acoustic structure of male aggressive vocalizations. *Bioacoustics.* **10**:259-285.
- Sanvito S., Galimberti F., 2000b. Bioacoustics of southern elephant seals. II. Individual and geographical variation in male aggressive vocalizations. *Bioacoustics.* **10**:287-307.

- Sanvito S., Galimberti F., 2003. Source level of male vocalizations in the genus *Mirounga*: repeatability and correlates. *Bioacoustics*. **14**:45-57.
- Schneider R., 1964. Der larynx der Säugetiere. *Handbuch der Zoologie, Bd. 8, T. 5, Beitr.* 7.1-128.
- Shipley C., Hines M., Buchwald J.S., 1981. Individual differences in threat calls of northern elephant seal bulls. *Animal Behaviour*. **29**:12-19.
- Shipley C., Hines M., Buchwald J.S., 1986. Vocalizations of northern elephant seal bulls: development of adult call characteristics during puberty. *Journal of Mammalogy*. **67**:526-536.
- Shipley C., Stewart B.S., Bass J., 1992. Seismic communication in Northern elephant seals. In: *Marine Mammal Sensory System* (Thomas J., Kastelein R., Supin A. eds). New York: Plenum press; 553-562.
- Sonntag C.F., 1921. The comparative anatomy of the koala (*Phascolarctos cinereus*) and vulpine phalanger (*Trichosurus vulpecula*). *Proceedings of the Zoological Society of London*. **39**: 547-577.
- Trexler J.C., Travis J., 1993. Nontraditional regression analysis. *Ecology*. **74**:1629-1637.
- Zuberbuhler K., Noé R., Seyfarth R.M., 1997. Diana monkey long-distance calls: messages for conspecifics and predators. *Animal Behaviour*. **53**:589-604.

VIII - CONCLUSIONS

VIII.1 Mating system, inter-male competition, and the role of communication

Elephant seals, males in particular, are a bizarre product of biological evolution. They show extreme adaptations to life at sea, including an exceptional diving capability, but maintain a strong bond to land, hauling out for breeding, and remaining on land for prolonged periods of time, that may last up to a hundred days for adult males (Le Boeuf and Laws, 1994). Although this life cycle resembles the cycle of other phocids, and pinnipeds at large, in no other species is the switch between the aquatic and land phase so extreme. This contrast is mirrored in the social system. Elephant seals are fully solitary during the feeding phase at sea, but they show a strong gregariousness when they are on land for breeding and moulting (Le Boeuf, 1991). During the breeding season, this gregarious tendency produces a complex social system, with breeding units (*harems*) that may comprise hundreds of individuals (Le Boeuf, 1974; McCann, 1980). The result is the most polygynous mating system observed in all vertebrates, with the highest level of inequality in the distribution of both copulations and genetic paternities (Fabiani et al., 2004; Galimberti et al., 2002), and with the biggest variation in individual lifetime breeding success ever recorded (Le Boeuf and Reiter, 1988; at SLI the maximum estimated number of females inseminated by a single male was 365, unpublished data). This exceptionally high level of despotism in access to breeding females is the result of a strongly structured mechanism of inter-male competition.

Elephant seals form local dominance hierarchies that are the result of the outcome of dyadic agonistic contests. Dominance hierarchies are linear, in particular in the SES (Galimberti et al., 2003) and the access to females shows a high correlation with the position in the dominance hierarchy. This holds both for the harem holders, that get control of harems whose size is proportional to their rank, and for the peripheral males that, although having much more limited mating opportunities, have anyway a mating success proportional to their rank (unpublished data). Being so much based on male competition, and offering such a high breeding potential for successful males, the elephant seals mating system should have generated strong selection pressures on male phenotypic traits that may improve male competition success (Le Boeuf and Reiter, 1988).

The size and morphology of male elephant seals seem to be the results of a process of improvement of fighting capabilities. Notwithstanding the clear fecundity advantage of bigger size in females (Arnbom et al., 1993; Reiter et al., 1981), both species of the genus show a very high sexual dimorphism in body size, higher in the SES (Le Boeuf and Laws, 1994), with the biggest males weighing up to ten times the average adult female. Males have a two-phase body growth, with a notable growth spurt after puberty (Clinton, 1994; Laws, 1953). Although the growth spurt is typical of most polygynous pinnipeds (McLaren, 1993), the difference in growth rate between the first and the second phase is bigger in elephant seals. Moreover, as I have shown in Chapter 2, SES males are peculiar, because they show an almost linear post-puberty growth, without a clear asymptote, and with a sustained growth rate even at later ages, when NES males have already stopped growing. Therefore, there is large variation in body size among

breeding males, and the difference in body size between harem holder and peripheral males is particularly big in the SES. Elephant seals are also dimorphic in shape of the body. The mature males have a rather different skeleton morphology and external shape from the females, with the barycentre of the body moved forward, more developed shoulders and thorax, much bigger bones and higher proportion of muscles (Bryden, 1972), a thick dermal shield in the chest (Laws, 1953), and enlarged canine teeth (Briggs and Morejohn, 1975), all traits useful during fights.

Fighting is a costly process (Braschi, 2004; Haley, 1994), for the loser but also for the winner, because it involves the risk of wounds (Deutsch, 1990), the physiological stress (shown by the rise of plasma cortisol, unpublished data), and an energy expenditure. From an energy point of view, the main cost of reproduction for elephant seal males, which fast while on land for breeding, is maintenance, but the intensity of behavioural activities may surely affect the energy expenditure of large animals adapted to an aquatic lifestyle and with awkward mobility on land (Deutsch et al., 1990; Galimberti et al., submitted). Therefore, selection should have favoured a suite of behavioural adaptations that may reduce the frequency of direct aggression and fights, and permit conflict resolution through assessment and signalling. The most conspicuous of these adaptations shown by elephant seals are agonistic vocalizations (Bartholomew, 1952; Laws, 1956).

VIII.2 Vocal communication and learning in male elephant seals

Southern elephant seal males make much use of vocalizations during agonistic contests,

which are dyadic social interactions that may include visual and vocal signals, chases and direct fights (Braschi, 2004). Vocalizations are the most common and frequent behavioural pattern, and at least one of the males vocalizes during most contests (Chapter 4). Moreover, vocalization is an effective behavioural pattern, because it is the single pattern that most frequently settles the contest (*i.e.*, produces the retreat of the other male; Braschi, 2004). In both species of elephant seals, the most frequent kinds of agonistic contests are the interactions between a harem holder and the peripheral males more or less steadily associated with its harem (unpublished data). These can be considered contests for the *status quo* maintenance, and they are in most cases settled by the harem holder vocalization, followed by the retreat of the peripheral male, without any chase or fight. Vocalizations permit the harem holder to keep a good control of the situation inside its harem without moving and, therefore, with a low energy expenditure. This may have a crucial importance for animals whose morphology and locomotion behaviour are not well suited to movements on land.

Before puberty, males have a sporadic presence on land during the breeding season, usually concentrated at its end. Although these males come to land mainly for moulting, they start showing the typical patterns of agonistic behaviour, including vocalizations. At the beginning, their vocalizations are scarcely structured, the sounds emitted by the same male are highly variable, and the repeatability of all acoustic features is low. After puberty, and together with the increase in rate of body growth, vocalizations became gradually more structured, until they become fixed, with each male emitting only a specific vocalization (Chapter 4). The presence on land during the breeding season of young and sub-adult males is rather puzzling, because they have a low chance of mating

but pay a high cost for attendance, suffering a substantial loss of body mass. The breeding effort of these males is similar to the one of more successful breeding males, but their reproductive success is much lower (Galimberti et al., submitted). It has been suggested that fasting costs are offset by gains in social experience, which may improve capability of competing for access to females in the following breeding seasons (Deutsch et al., 1994). Experience significantly improves the breeding performance in elephant seal females (Huber et al., 1991; Sydeman and Nur, 1994), and this may hold also for males. Although suggestive, this hypothesis has not received much support yet. Moreover, the specific components of this process of learning of social skills were not clear. The acquisition of the capability to vocalize can be such a component. As I have shown (Chapter 4), the distribution of vocal types along the years is well in accordance with a process of vocal imitation by young male elephant seals, through copying of vocal characteristics of other individuals, and older breeding males in particular. This process of vocal learning may be an important component of the development of social competence in male elephant seals, and may explain why most elephant seal males haul out for the first time during the breeding season just after puberty, when they are not yet powerful enough to actually compete for mate access.

VIII.3 Behavioural and acoustic ontogeny of vocalizations

Male elephant seals show a clear ontogenetic trend in their involvement in social interactions, in the use of ritualized forms of agonistic behaviour, in the use of vocalizations and in the effectiveness of its use in the resolution of agonistic contests.

This tendency towards the ritualization of agonistic behaviour, and the increase in the use and effectiveness of vocalizations, can reduce the costs of direct aggression. Various acoustic features of the agonistic vocalizations emitted by SES males show an ontogenetic variation with age (Chapter 6), in particular when the gross categories of young and adult males are compared. Vocal ontogeny can be the product of two main processes, the vocal learning of acoustic features (*i.e.*, the within-individual change in acoustic features of vocalizations due to auditory experiences), and the maturation process due to the change in the structural phenotype during growth that affects the structures used to produce the sounds (Egnor and Hauser, 2004). The maturation process should be prevalent for acoustics features that depend on morphology and body growth, while vocal learning could be prevalent for non morphologically constrained acoustic features..

The *source-filter theory* of sound production, originally developed to model human speech, has general applicability to mammals, because all species share the basic mechanism of sound production (Fitch and Hauser, 2002). Typical mammal vocalizations are produced by the larynx (the *source*) and then filtered by the vocal tract (the *filter*), before being emitted through the nostrils and lips. The rate of oscillation of the periodic or quasi-periodic source is responsible for the fundamental pitch of the sound, *i.e.*, its fundamental frequency. The resonances of the vocal tract act as a filter on the original sound, selectively “amplifying” some frequencies by damping others, thus producing the formant frequencies. Overall, the formant frequencies and their spacing should decrease with increase in vocal tract length, while the F0 should decrease with increasing size and mass and decreasing tension of the vocal folds. Mammals are able to change the vibrating

or effective size, shape and tension of their vocal folds, hence changing the fundamental frequency, while the vocal tract length is constrained by the bones of the skull and, hence, can in principle be changed less. Therefore, while temporal and structural features of the vocalizations should be almost free from physical constraints, the formants should be strictly dependent on the animal's morphology, size and age. Accordingly to this theory (Chapter 6), in SES the formants are the acoustic features that show the strongest ontogenetic trend of change with age, with a linear decrease up to age 7-8, and a more clear trend for the higher formants. On the other side, and again in accordance with the theory, the temporal features and the syllables structure of the vocalizations show no clear trend of change with age, and even the differences between young and old males are blurred. Moreover, the frequency features that are not related to the vocal tract length also show no ontogenetic trend. I have shown (Chapter 4) that young males tend to mimic and adopt the vocal type of older, more successful males. This result is confirmed by the ontogenetic trend found for the temporal and structural features of their vocalizations. Young elephant seals are able to produce the same pulse trains that are the building blocks of the vocalizations of mature males, but they are not able to assemble them into coherent and constant vocalization patterns. The increase in structure of the vocalizations observed during growth should be related to an increase in competence to assemble the pulse trains, *i.e.*, a vocal learning process. The result is the emission by adults of strongly structured vocalizations, specific for each individual and stereotyped, and different between individuals, with no clear constraint due to the structural phenotype.

VIII.4 The function of agonistic vocalizations

In recent years, a lot of attention has been given to the function of acoustic signals (Bradbury and Vehrencamp, 1998). In particular, it has been frequently suggested that acoustic signals may convey information about the phenotype of the emitter and, hence, be *honest* signals (Fitch and Hauser, 2002; Reby and McComb, 2003). Although the literature contains various anecdotal statements about the role of vocal behaviour in elephant seal reproduction (McCann, 1981; Sandegren, 1976), there is almost no attempt to test specific hypotheses about the function of vocalizations.

The first candidate in the list of possible acoustic features that can transmit reliable information about the phenotype is the sound level, because it depends on the air pressure generated from the lungs, which is in turn related to size. Since lung size and body size are correlated in vertebrates, any acoustic measure related to lung size should also be related to body size (Fitch and Hauser, 2002). I showed (Chapter 5) that the sound level has a high repeatability both in southern and northern elephant seals, and is related to age class and size of males, but the relationship is not very strong, it is quite variable, and only the extreme age classes present significant differences. Therefore, the sound level of male vocalizations may convey information on gross differences between phenotype classes (*i.e.*, adults versus non adults, big versus small), but is not enough correlated to the structural phenotype to be a good candidate for transmission of high resolution information on the male phenotype and its resource holding potential.

Of the frequency features, the fundamental frequency is not a good candidate as an

honest signal, because it depends on the mass, length and tension of the vibrating section of the vocal folds, which can be modified over a considerable range by the action of the laryngeal muscles. Much better candidates are the formants, which are constrained by the length of the vocal tract and, therefore, should be well related to body size. Formants and their spacing (*i.e.*, the formant dispersion) should decrease with increase in vocal tract length. As I have shown (Chapter 7), formants of SES agonistic vocalizations, and in particular the upper one sampled (F5), explain a significant proportion of the variance in age, size, and resource holding potential at large. Therefore, the information content of vocalizations can, potentially, be used to settle agonistic contests without the need for direct interactions and fights. In elephant seals, the frequency features that convey more information about the phenotype are the upper formant (F5) and the minor formant. The amount of information carried by the other formants analyzed (F1 to F4) decreases gradually going towards the lowest one (F1). The higher information content of upper formants with respect to lower ones is not surprising, since the lower formants are known to depend strongly on the shape of the supra-laryngeal vocal tract, which can be modified during sound emission. The presence of the minor formant is interesting, because it points toward a role of the proboscis in the emission of vocalizations.

The proboscis is the most peculiar component of elephant seal morphology. The southern elephant seal was in fact named *Macrorhinus proboscideus*, although the name *Macrorhinus* was then abandoned in favour of *Mirounga* because it was already pre-occupied by a genus of *Coleoptera* (Sheffer, 1958). The conspicuousness of the proboscis was noted from the beginning of evolutionary biology (Darwin, 1871), and it soon became a textbook example of secondary sexual traits. I have showed that, contrary to the

statements present in the literature (McCann, 1981), the proboscis has well defined development with growth, and is therefore a good index of age, at least for gross age categories, and shows a clear positive allometry. The lack of specialized behavioural postures to enhance the visibility of the proboscis, and the fact that the contestants are usually front to front, suggest that the role of the proboscis as visual signal is secondary, and limited to a generic indication of arousal. On the contrary, the connection of the nasal tract with the vocal tract, the fact that agonistic vocalizations are always emitted with expanded proboscis, and the fact that air is emitted through the proboscis during vocalization, all suggest an important role of the proboscis in sound emission. My analysis (Chapter 7) indicated the minor formant as the second most important component of the vocalizations, after the F5, in conveying information about the emitter phenotype. The minor formant is related to the proboscis, and its strongest relationship with the phenotype is with the proboscis length. Therefore, the minor formant is very likely the result of the resonances due to the nasal passage. This is confirmed by the application of the source-filter theory. To produce the observed range of the minor formant, a hypothetical vocal tract made by the oral part only would have to be unreasonably long; whereas, assuming that the minor formant is produced nasally, the theoretical tract length is well in accordance with the measures obtained from the lateral pictures of vocalizing elephant seals. In all, the presence of the minor formant, its position in the vocalization power spectrum, and its low amplitude with respect to the other formants, support the idea that the nasal tract is in fact involved in male elephant seal vocalizations, representing a branch extension of the oral tract.

Although my results confirm that formants may convey reliable information about

the phenotype of the emitter and can be honest signals, they also show that the variance of phenotypic traits explained by the formants is rather low. The information content of the formants observed in elephant seals is in accordance with previous results in other species (Reby and McComb, 2003), which show that formants rarely explain more than 40% of the variance in phenotypic traits. Most authors consider these evidences as a final confirmation of the honest role of vocalizations, but I suggest that this low amount of variance explained dictates caution. The percentage in variance of phenotypic traits not explained by variation in the formants is in most cases more than 50%. Therefore, the use of formants as an exclusive phenotypic assessment system is, at least, dubious. Many factors can reduce the capability of formants to convey information about the phenotype. Different pressures can influence the growth of various bony structures of the skull, producing a development pattern quite independent from simple body growth. Even in humans, strong correlations between formants and phenotype were obtained only when lumping together data from structurally different groups, and much lower correlations were found within homogeneous groups (Rendall et al., 2005). Therefore, the relevance of formants as honest signals of phenotype should not be overstated. In elephant seals, and in mammals at large, signalling systems are complex, multi-channel phenomena (Miller, 1991) and, therefore, the exclusive concentration on a limited and specific cue can be misleading. In elephant seals, vocalizations are more effective when the resource holding potential of the males is distinctly different, for example during confrontations between males of different age classes (Braschi, 2004). The formants can be used to settle contests when there are gross differences between males, because, in these cases, even the rather low percentage of variance in phenotype explained by the formants may permit a

reliable assessment of the opponent phenotype from vocalizations. On the contrary, when the contestants have similar resource holding potential the contest should be settled by a fight, that permits a direct reciprocal assessment of size and stamina. This is, in fact, what usually happens (Braschi, 2004).

VIII.5 Drawbacks of the study and future developments

My study has the intrinsic drawbacks of any observational study. Its evidence is correlational, and derived from observational data and, hence, only suggest causation, not prove it (Quinn and Dunham, 1983). This is a basic drawback of many studies in behavioural ecology, where natural experiments are not applicable or feasible in practice, or are untenable on ethical ground (Cuthill, 1991). The leading approach in the study of acoustic communication is obviously to set up playback experiments. I was unable to apply this approach to male elephant seals, because it was not possible to devise a realist playback set up, in particular because of the very high source level of male SES vocalizations (Chapter 5). Preliminary playback experiments demonstrated that, as expected, a realistic setup requires the emission of sounds with a source level comparable to natural sounds. Unfortunately, the emission of playback sounds with a so high sound level and without distortion is very difficult to obtain, in particular in field conditions. Moreover, many other logistic problems (aggressiveness of the study animals, need to isolate and control experimental individuals, etc) hamper the realization of a realistic experimental setting. Rendell and Whitehead (2001) advocated the use of an “ethnographic” approach to the study of vocal communications in natural populations of

species that, due to practical or ethical constraints, cannot be studied by playback experiments. This approach, which has uncovered many interesting features of vocal communication in marine mammals, can be strengthened by the collection of longitudinal data on known individuals, and by inclusion of the early stages of vocal ontogeny. This was the approach that I adopted in my study.

Although my work has clarified some aspects of male communication during agonistic contests, various other factors may be involved, and deserve further investigation. A main problem in the study of multi-channel communication systems is the observer bias, due to the specific features and constraints of the human sensory system (*e.g.*, Endler, 1990). What is more conspicuous and appealing for human beings is not necessarily the most relevant signal for other species. My choice to concentrate on acoustic communication was in part due to this bias. I considered just signals emitted in air, because they are so conspicuous, while it is known that vocalizations can also produce vibrations that are transmitted by the ground. Elephant seals spend most of their time lying flat on the ground, having a large proportion of the body surface in contact with it. Moreover, some preliminary experiments showed that they are able to perceive vibrations transmitted by the ground, even when the power of the source of the experimental vibrations is much lower than the power of the typical agonistic vocalization. The vibrations produced by a vocalizing male and transmitted through the ground can be easily perceived by a human being within the usual range of distances of interacting males. The importance of seismic communication has only now begun to be appreciated (Hill, 2001) and, although some preliminary research was carried out on seismic communication in the NES, the available information is rather scarce (Shipley et

al., 1992). NES males and females can surely produce and detect substrate-borne vibrational signals, but it is yet to be proved that these signals are a true form of communication, and not a simple by-product of vocalizations.

Acoustic signals, transmitted by air or ground, may be just a part of the story. Communication systems are often complex and multi-channel (Miller, 1991), and elephant seals may use visual or olfactory cues together with acoustic features in the evaluation of the contestant resource holding potential, or for its individual recognition. Elephant seals have a well developed agonistic behaviour, including stereotyped action patterns and sequences, with an escalation from indirect threats to direct aggression. Some of these patterns may simply convey a general cue of the arousal level, while others seem to be targeted to permit a reciprocal evaluation of size. The plain inflation of the proboscis is often considered a signal of the arousal (McCann, 1981; Sandegren, 1976), but it is a very non-specific signal, because all breeding males, at least in the SES, keep their proboscis rather steadily inflated during the whole time of the breeding season. Therefore, the inflation of the proboscis can at best indicate if a male is in breeding condition or not. More interesting are the postures adopted in the initial phase of contests, because they may represent ways to advertise the body size and improve assessment. A notable aspect of SES agonistic behaviour is the lack of postures of lateral exhibition, similar to the “parallel walk” observed in most ungulates, that is usually assumed to be a posture to facilitate the reciprocal assessment of body size (Clutton-Brock et al., 1979) (Clutton-Brock et al., 1979; but see Jennings et al., 2003). On contrary, during agonistic contests, male elephant seals usually face one the other, and show a suite of stereotyped behavioural postures to show their front area (Braschi, 2004).

The role of olfactory cues in elephant seals agonistic behaviour is currently unexplored. Chemical signals, and pheromones in particular, play a crucial role in mammalian breeding biology (Bronson, 1989). In principle, with such a big nose, elephant seal males should be able to make ample use of olfactory cues. On the contrary, they seem to even lack the most frequent and basic olfactory assessment behaviour of mammals, *i.e.*, the checking of the female oestrus. In many mammal species, including various pinnipeds, males have specialized behavioural patterns that permit the assessment of the breeding status of the females (*e.g.*, the *flehmen* of ungulates; Estes, 1972). Male elephant seals show none of these behaviours, not even the plain sniffing of female genitalia. If this can be considered an indication of a minor role of olfactory cues in elephant seal social behaviour, and male-male competition in particular, is open to question.

In conclusion, although my research filled some gaps, many others remain, and they will be the target of my future studies of the elephant seal communication system. My first goal will be to compare the vocalization behaviour between the two species of the genus *Mirounga*. The literature on elephant seals seems to suggest strong similarities in all aspect of the biology of the two species (Le Boeuf and Laws, 1994), in particular regarding the breeding biology, although this is not always the case (*e.g.*, Galimberti et al., 2000a; Galimberti et al., 2000b). The same holds for acoustic communication (Le Boeuf and Petrinovich, 1974). I recently started a comparative study of vocalizations and agonistic behaviour at large between the Sea Lion Island population of SES, and the NES population of the San Benitos Islands (Baja California, Mexico). A common problem of inter-specific comparison is difficulty of being sure that the eventual differences found

are real biological differences, and not artefacts of the different data collection and analysis protocols (Fabiani et al., 2004). I am applying the same study protocol on both SES and NES, using the same definitions, field methods, and data analysis. The picture which is slowly emerging is quite different from the orthodox view found in the literature. The differences between SES and NES were often considered secondary results of the basic differences in topography, demography and socionomy (*e.g.*, harem size, female density). I am, on the contrary, discovering various deep differences in structural aspects of behaviour, including differences in the acoustic structure of signals, in the agonistic behaviour action patterns, in the frequency and effectiveness of vocalizations. This factors seem to produce differences in the mating system, in the distribution of mating success, and in phenotypic sexual selection pressure even when the effect of the different demography and socionomy is accounted for.

A second aspect that I am currently investigating is the role of hormones in the regulation of vocalizations and agonistic behaviour at large. Hormone studies are becoming an important area of research on marine mammals, because they are linked to social behaviour, have important implications for physiology, and are an excellent index of human induced stress. I have devised a new, low-invasive, method that permits serial sampling of blood of unrestrained male elephant seals, and the collection of blood from natural wounds after fights (Sanvito et al., 2005). I am studying in particular the two hormones that seem to be more involved in the control of male behaviour, testosterone and cortisol, which are much related to agonistic behaviour in mammals (Muller and Wrangham, 2004) and pinnipeds in particular (Bartsh et al., 1992). Until now, the variation of testosterone of SES males was studied on a gross time scale and in a small

sample of killed individuals (Griffiths, 1984), but nothing is known about the variation of testosterone of specific individuals during the breeding season, and in relation to agonistic and vocalization behaviour. My preliminary results indicate that testosterone has a predictable seasonal pattern, with a peak at the beginning of the season, and a gradual decrease thereafter. Older males, that arrive on land first and then get control of the biggest harems, have an advanced peak with respect to peripheral males, that arrive later. This is in accordance with their general breeding status, their agonistic behaviour, and their use of vocalizations. On the contrary, cortisol has no clear seasonal pattern, and it is more related to the day-by-day events. In particular, my preliminary results show that fighting involves a surge of cortisol in both the winner and the loser. This is the indication of a physiological stress, that represents an additional cost of fighting, never previously investigated, that may have favoured the settlement of contests by assessment.

The last aspect I am currently investigating is the development of a data collection protocol that may permit the evaluation of elephant seal communication during agonistic contests in a multi-channel perspective. The use of this approach, in which all the potential channels of the receiver sensory system are investigated at the same time, is frequently advocated, but rarely implemented, most likely due to the methodological and practical problems. Although I extensively used videotaping of males during agonistic contests and vocalization emission, I encountered significant problems in converting videotapes into quantitative information. Although I have a well developed and abundantly tested ethogram of elephant seals agonistic behaviour, and although my research team developed a specialized software for the coding of videotapes, I discovered that the resolution of the behavioural sequences obtained is not adequate for a full study

of the communication system put in place by elephant seals during agonistic contests. The main problem is to code the movement of the animals in an objective way (Chiara Braschi, pers. comm.). A possible solution is to apply the Eshkol-Wachmann notation system, that was originally developed to describe human choreography using a coordinate system that can be referred to both the acting individual or a partner. Although this system has been already proposed to study animal behaviour (Golani, 1976), it has been rarely used, because the high resolution obtained came at great cost, due to the complexity of its application. This drawback can be possibly solved with the implementation of an adequate software, that will permit the coordinate coding directly on video frames, a solution that I am currently investigating. The second problem is to investigate possible seismic communication. Luckily, the development of high resolution geophones at a reasonable cost will permit the use of arrays of seismic sensors that should allow the study of intensity, frequency, and direction of seismic signals, and to evaluate their relationship with the behavioural reaction of the receiving individuals. The most difficult problem is the evaluation of the role of olfactory signals. Although some research on the role of chemical signals in mammal communication has been carried out (Muller-Schwarze, 1984), this represents a rather unexplored frontier in mammal behaviour studies (Sun and Mueller-Schwarze, 2004).

VIII.6 LITERATURE CITED

- Arnbom T., Fedak M.A., Boyd I.L., McConnell B.J., 1993. Variation in weaning mass of pups in relation to maternal mass, postweaning fast duration, and weaned pup behaviour in southern elephant seals (*Mirounga leonina*) at South Georgia. *Canadian Journal of Zoology*. **71**:1772-1781.
- Bartholomew G.A., 1952. Reproductive and social behavior of the northern elephant seal. *Univ. Calif. Publ. Zool.* **47**:369-472.
- Bartsh S.S., Johnston S.D., Siniff D.B., 1992. Territorial behavior and breeding frequency of male Weddel seals (*Leptonychotes weddelli*) in relation to age, size, and concentration of serum testosterone and cortisol. *Canadian Journal of Zoology*. **70**:680-692.
- Bradbury J.W., Vehrencamp S.L., 1998. *Principles of Animal Communication*. Massachusettes: Publishers. Sunderland.
- Braschi C., 2004. Confronti agonistici nell'elefante marino del sud: fattori coinvolti e ruolo delle asimmetrie tra due maschi. (Male agonistic behavior in southern elephant seals: factors and asymmetries involved in conflict.) (PhD). Roma: Università La Sapienza di Roma.
- Briggs K.T., Morejohn G.V., 1975. Sexual dimorphism in the mandibles and canine teeth of the Northern elephant seal. *Journal of Mammalogy*. **56**:224-231.
- Bronson F.H., 1989. *Mammalian reproductive biology*. Chicago: University of Chicago Press.

- Bryden M.M., 1972. Body size and composition of elephant seal (*Mirounga leonina*): absolute measurements and estimate from bone dimensions. *Journal of Zoology London*. **167**:265-276.
- Clinton W.L., 1994. Sexual selection and growth in male Northern Elephant Seals. In: *Elephant seals. Population ecology, behavior, and physiology* (Boeuf B.J.L., Laws R.M. eds). Berkeley (CA): University of California Press; 154-168.
- Clutton-Brock T.H., Albon S.D., Gibson R.M., Guinness F.E., 1979. The logical stag: adaptive aspects of fighting in red deer (*Cervus elaphus* L.). *Animal Behaviour*. **27**:221-225.
- Cuthill I., 1991. Field experiments in animal behaviour: Methods and ethics. *Animal Behaviour*. **42**:1007-1014.
- Darwin C., 1871. *The descent of man and selection in relation to sex*, 1 ed. London: John Murray.
- Deutsch C.J., 1990. Behavioral and energetics aspects of reproductive effort of male northern elephant seals (*Mirounga angustirostris*) (Ph.D. Thesis). Santa Cruz (CA): University of California.
- Deutsch C.J., Crocker D.E., Costa D.P., Le Boeuf B.J., 1994. Sex- and age-related variation in reproductive effort of Northern Elephant Seals. In: *Elephant seals. Population ecology, behavior, and physiology* (Le Boeuf B.J., Laws R.M. eds). Berkeley (CA): University of California Press; 169-210.
- Deutsch C.J., Haley M.P., Le Boeuf B.J., 1990. Reproductive effort of male Northern elephant seals: Estimates from mass loss. *Canadian Journal of Zoology*. **68**:2580-2593.

- Egnor R.S.E., Hauser M.D., 2004. A paradox in the evolution of primate vocal learning. *TRENDS in neurosciences*. **27**:649-654.
- Endler J.A., 1990. On the measurement and classification of colour in studies of animal colour patterns. *Biological Journal of the Linnean Society*. **41**:315-352.
- Estes R.D., 1972. The role of the Vomeronasal Organ in Mammalia reproduction. *Mammalia*. **36**:315-341.
- Fabiani A., Galimberti F., Sanvito S., Hoelzel A.R., 2004. Extreme polygyny among southern elephant seals at the Falkland Islands: behavioral estimates and genetic paternity. *Behavioral Ecology*. **15**:961-969.
- Fitch W.T., Hauser M.D., 2002. Unpacking "honesty": vertebrate vocal production and the evolution of acoustic signals. In: *Acoustic Communication* (Simmons A.M., Popper A.N., Fay R.R. eds). New York: Springer-Verlag.
- Galimberti F., Boitani L., Marzetti I., 2000a. Female strategies of harassment reduction in southern elephant seals. *Ethology Ecology & Evolution*. **12**:367-388.
- Galimberti F., Boitani L., Marzetti I., 2000b. Harassment during arrival to land and departure to sea in southern elephant seals. *Ethology Ecology & Evolution*. **12**:389-404.
- Galimberti F., Fabiani A., Boitani L., 2003. Socio-spatial levels in linearity analysis of dominance hierarchies: a case study on elephant seals. *Journal of Ethology*. **21**:131-136.
- Galimberti F., Fabiani A., Sanvito S., 2002. Measures of breeding inequality: a case study in southern elephant seals. *Canadian Journal of Zoology*. **80**:1240-1249.

- Galimberti F., Sanvito S., Braschi C., Boitani L., submitted. The cost of success: reproductive effort in male southern elephant seals. *Behavioral Ecology and Sociobiology*.
- Golani I., 1976. Homeostatic motor processes in mammalian interactions: a choreography of display. In: *Perspectives in ethology* (Bateson P.P.G., Klopfer P.H. eds). New York: Plenum Press; 69-134.
- Griffiths D.J., 1984. The annual cycle of the testis of the elephant seal (*Mirounga leonina*) at Macquarie Island. *Journal of Zoology London*. **203**:193-204.
- Haley M.P., 1994. Resource-holding power asymmetries, the prior residence effect, and reproductive payoffs in male northern elephant seal fights. *Behavioral Ecology and Sociobiology*. **34**:427-434.
- Hill P.S.M., 2001. Vibration and Animal Communication: A Review. *American Zoologist*. **41**:1135-1142.
- Huber H.R., Rovetta A.C., Fry L.A., Johnston S., 1991. Age-specific natality of northern elephant seals at the South Farallon Islands, California. *Journal of Mammalogy*. **72**:525-534.
- Jennings D.J., Gammell M.P., Carlini C.M., Hayden T.J., 2003. Is the parallel walk between competing male fallow deer, Dama dama, a lateral display of individual quality? *Animal Behaviour*. **65**:1005-1012.
- Laws R.M., 1953. The elephant seal (*Mirounga leonina* Linn.). I. Growth and age. *Scientific Reports of the Falkland Islands Dependencies Survey*. **8**:1-62.

- Laws R.M., 1956. The elephant seal (*Mirounga leonina* Linn.). II. General, social, and reproductive behaviour. *Scientific Reports of the Falkland Islands Dependencies Survey*. **13**:1-88.
- Le Boeuf B.J., 1974. Male-male competition and reproductive success in elephant seals. *American Zoologist*. **14**:163-176.
- Le Boeuf B.J., 1991. Pinniped mating systems on land, ice and in the water: Emphasis on the Phocidae. In: *Behaviour of Pinnipeds* (Renouf D. ed). London: Chapman and Hall; 345-394.
- Le Boeuf B.J., Laws R.H., 1994. Elephant seals: an introduction to the genus. In: *Elephant seals. Population ecology, behavior and physiology* (Le Boeuf B.J., Laws R.H. eds). Berkeley, CA: University of California Press; 1-26.
- Le Boeuf B.J., Petrinovich L.F., 1974. Elephant seals: interspecific comparisons of vocal and reproductive behavior. *Mammalia*. **38**:16-32.
- Le Boeuf B.J., Reiter J., 1988. Lifetime reproductive success in northern elephant seals. In: *Reproductive success. Studies of individual variation in contrasting breeding systems* (Clutton-Brock T.H. ed). Chicago: University of Chicago Press; 344-362.
- McCann T.S., 1980. Population structure and social organization of Southern elephant seals, *Mirounga leonina* (L.). *Biological Journal of the Linnean Society*. **14**:133-150.
- McCann T.S., 1981. Aggression and sexual activity of male Southern elephant seals, *Mirounga leonina*. *Journal of Zoology London*. **195**:295-310.
- McLaren I.A., 1993. Growth in pinnipeds. *Biological Reviews*. **68**:1-70.

- Miller E.H., 1991. Communication in pinnipeds, with special reference to non-acoustic signalling. In: *The behaviour of the Pinnipeds* (Renouf D. ed). London: Chapman and Hall; 128-235.
- Muller-Schwarze D., 1984. Chemical communication in mammals: ecological context and future research. *Acta Zool. Fenn.* **171**:55-56.
- Muller M.N., Wrangham R.W., 2004. Dominance, cortisol and stress in wild chimpanzees (*Pan troglodytes schweinfurthii*). *Behavioral Ecology and Sociobiology.* **55**:332-340.
- Quinn J.F., Dunham A.E., 1983. On hypothesis testing in ecology and evolution. *American Naturalist.* **122**:602-617.
- Reby D., McComb K., 2003. Anatomical constraints generate honesty: acoustic cues to age and weight in the roars of red deer stags. *Animal Behaviour.* **65**:519-530.
- Reiter J., Panken K.J., Le Boeuf B.J., 1981. Female competition and reproductive success in Northern elephant seal. *Animal Behaviour.* **29**:670-687.
- Rendall D., Kollias S., Ney C., 2005. Pitch (F0) and formant profiles of human vowels and vowel-like baboon grunts: The role of vocalizer body size and voice-acoustic allometry. *Journal of the Acoustical Society of America.* **117**:944-955.
- Rendell L., Whitehead H., 2001. Culture in whales and dolphins. *Behavioral and Brain Sciences.* **24**:309-382.
- Sandegren F.E., 1976. Agonistic behavior in the male Northern Elephant seal. *Behaviour.* **57**:136-158.

- Sanvito S., Galimberti F., Sanvito R., Braschi C., 2005. The "seal prick": a low invasive method for blood sampling in free ranging male elephant seals. *Marine Mammal Science*. **21**:210-217.
- Sheffer V.B., 1958. *Seals, sea lion, and walruses: a review of the Pinnipedia*. Stanford, CA: Stanford University Press.
- Shiple C., Stewart B.S., Bass J., 1992. Seismic communication in Northern elephant seals. In: *Marine Mammal Sensory System* (al. J.T.e. ed). New York: Plenum press; 553-562.
- Sun L., Mueller-Schwarze D., 2004. Heritability of kinship pheromone in the beaver: how is information about relatedness coded? *Acta Zoologica Sinica*. **50**:504-510.
- Sydeman W.J., Nur N., 1994. Life history strategies of female northern elephant seals. In: *Elephant seals. Population ecology, behavior and physiology* (Laws B.J.L.B.R.M. ed). Berkeley (CA): Un. California Press; 137-153.

APPENDIX I - ELEPHANT SEALS BREEDING BIOLOGY

AI.1 General description of elephant seals breeding biology

The evolution of communication systems is strongly constrained by specific features of the breeding biology and life history of the species (Bradbury and Vehrencamp, 1998). Therefore, it is useful to summarize the main aspects of the elephant seal breeding biology, in particular regarding the Sea Lion Island population (Figure AI.1), which is somehow peculiar due to its small size, isolation, low density, and rather low maximum harem size if compared to other nearby populations (Galimberti and Boitani, 1999).

Southern elephant seals are marine mammals strongly adapted to diving. During their yearly life cycle they spent most time at sea, and come back to land just for breeding and moulting (Carrick et al., 1962; Le Boeuf and Laws, 1994; Figure AI.2a). Breeding males usually come to land well before the haulout of the first female, and stay on land for three months and more. Mature females stay on land during the breeding season for about one month: during this period they give birth to a single pup, suckle it, come into oestrus, copulate and return to sea. Apart from a period of about 25 days per year in which they stay on land for the moult, they spend the rest of their life cycle doing almost continuous deep dives (up to more than one thousand meters deep), to get enough food to recover from the huge drop in weight and energy reserves sustained during lactation.

Elephant seals are large (southern elephant seal is the largest pinniped species) and show great sexual size dimorphism (the highest in land-breeding mammals; Figure AI.2b).

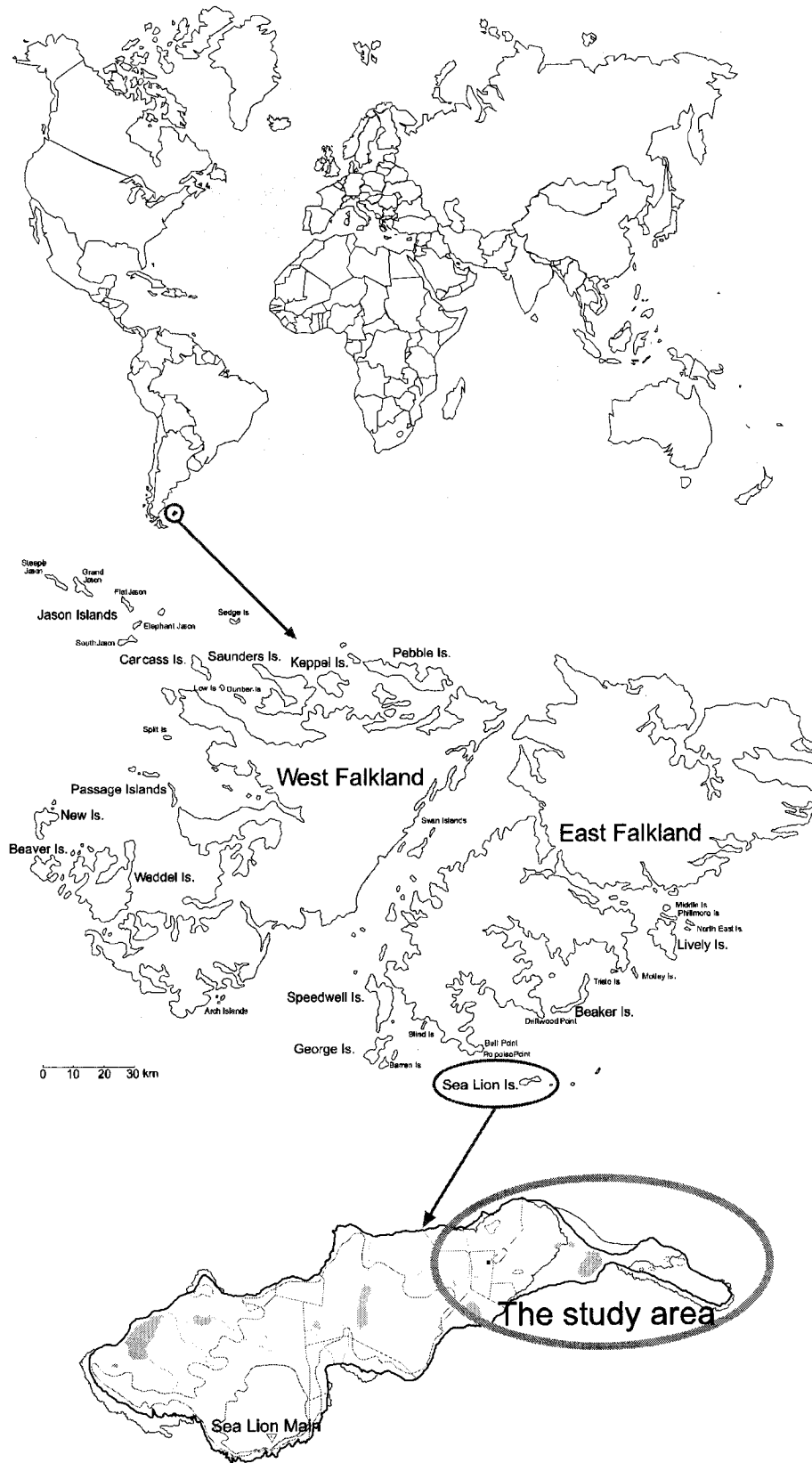
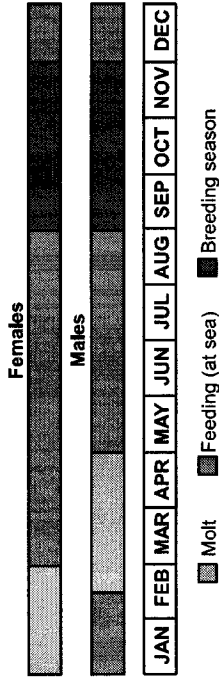
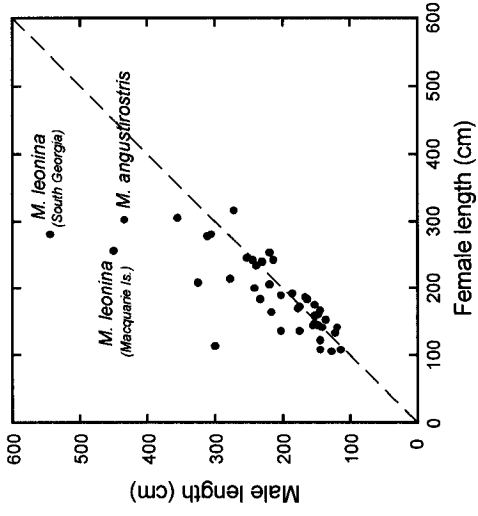

Figure AI.1 - The study site. Sea Lion Island is a small island situated in the southernmost part of the Falkland Islands archipelago.

A)



B)



C)

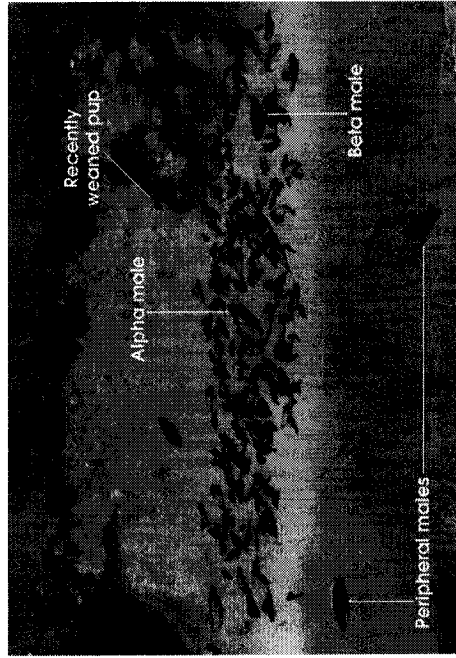

D)

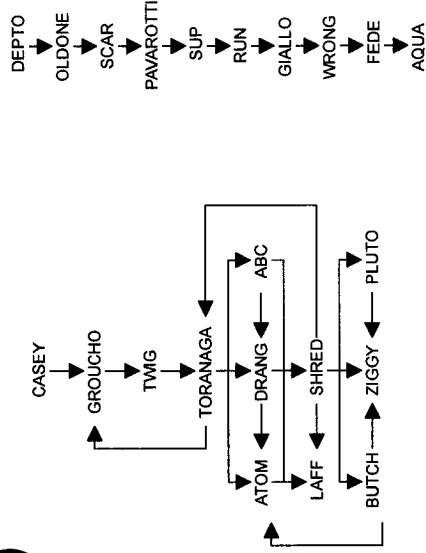

Figure AI.2 - Southern elephant seal biology. A) Annual cycle of adult males and females at Sea Lion island (unpublished data). B) Sexual dimorphism body size (body length) in southern and northern elephant seals is greater than in other pinnipeds (Filippo Galimberti, pers. com.). C) Aerial view of typical large breeding unit in Sea Lion Island (courtesy of Filippo Galimberti, ESRG). D) Example of typical dominance hierarchy in the northern (left; Riedman, 1990) and southern (right; Galimberti et al., 2003) elephant seal.

Due to this large dimorphism, males are actually able to herd females, and this has a strong impact on mating behaviour. Strong adaptation to aquatic life reduces mobility on land, and this favours females grouping and male control of them (Galimberti et al., 2000). Males have also well developed secondary sexual characters (proboscis, enlarged canines, frontal dermal shield), that appear to be the result of action of sexual selection and adaptation to intense male competition. They feed during the aquatic phases of the yearly cycle but completely fast during the terrestrial ones. The combination of fasting and concentrated breeding effort imply a significant energy stress and a serious mass loss for both sexes, that for males at Sea Lion Island may reach 50% of the body mass (Galimberti et al., submitted). This high and concentrated breeding effort was probably the driving pressure of a long series of life history adaptations (*e.g.*, delay of breeding in males; Clinton and Le Boeuf, 1993).

Growth of males is a two-phases process, with a post-pubertal growth spurt (Clinton, 1994). Maturation in males is very long, puberty is reached when they are about five years old, but true social maturity is reached only several years later (they usually are not able to get control of an harem until they are >8 years of age). Pre-breeding mortality of males is high, hence just a small percentage of each male cohort reaches full maturity and start breeding. During the breeding season females gather in groups (harems) of variable size (from 2 to hundreds). Usually one adult male is in charge of each harem, keeping other males away and doing most of the copulations. Colonial breeding is the first requirement for the evolution of a polygynous mating system. Reproduction is concentrated in a 3-month period, and most females breed during a small portion of the season (at Sea Lion Island 88% of copulations occur over three weeks (Galimberti et al.,

2000). A concentrated breeding season is an important requirement for the evolution of a despotic system of mate access (Clutton-Brock, 1989).

Females have a predictable pattern of presence on land during the breeding season (Galimberti and Sanvito, 2001), and this predictability has a significant effect on male mating tactics. At Sea Lion Island females begin to haul out during the second week of September; almost all the females have already gone back to sea by the third week of November (Figure AI.3a). The peak haulout of females is almost constant in each population. A typical female stays on land for 27 days: after a mean of 5 days spent on land she gives birth; then she suckles the pup for a mean of 20 days before coming into estrus; then she copulates for a mean of 2 days with the alpha male of the harem, while carrying on the lactation; at the end she weans the pup (after a mean of 23 days of suckling), leaves the harem and goes back to sea.

The mating system of elephant seals is the purest form of harem defence polygyny (Figure AI.2c). Males compete between themselves using both conventional competition and direct fights. The results of dyadic interactions set up an almost linear dominance hierarchy between males (Figure AI.2d), and rank in the hierarchy determines the breeding role. One male, called *alpha* or *harem master*, has an almost complete control of each female group, and most dominant males are in charge of the largest harems, which results in a very biased distribution of copulations (Figure AI.3b). *Beta* males (that is to say males that reside within the females group but subordinates to the alpha) are sometimes present in larger harems, but the most of the males which are not able to get control of an harem are kept outside the female group as *peripheral* males.

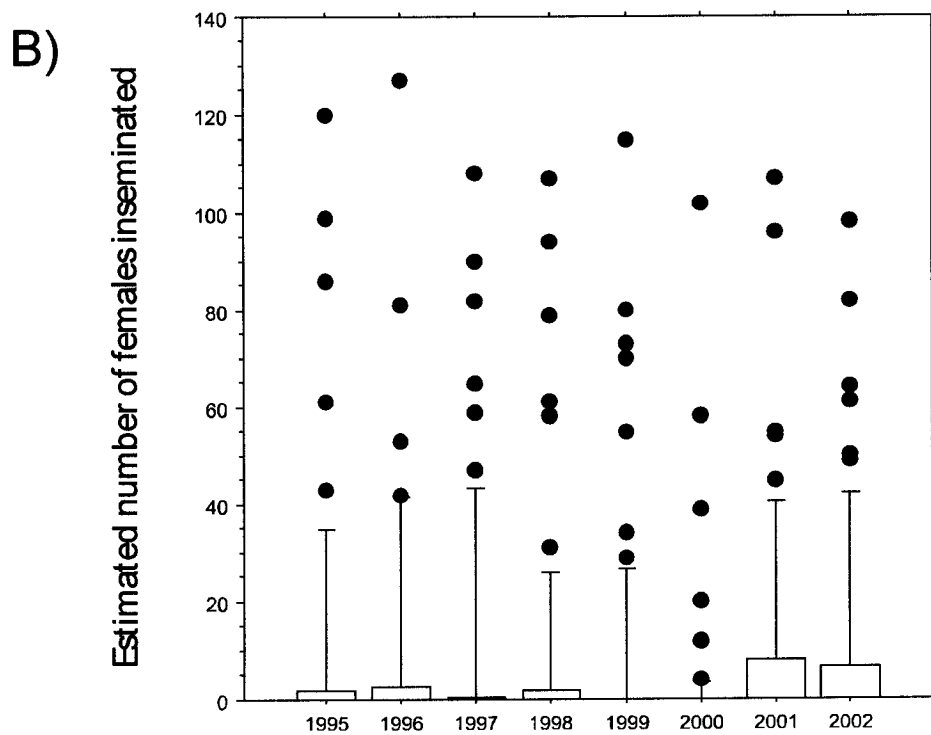
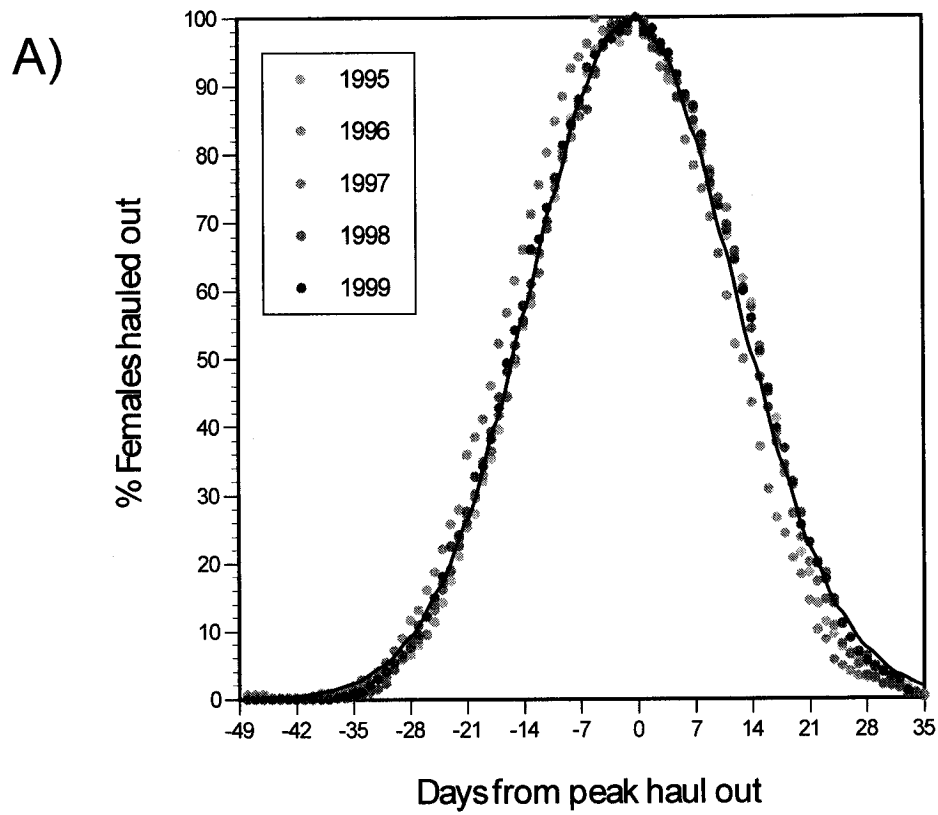

Figure AI.3 - Southern elephant seal breeding biology. A) Pattern of female haulout at Sea Lion Island during the breeding seasons 1995 to 1999. B) Boxplots of the distribution of the estimated number of females inseminated (ENFI: Le Boeuf, 1974) in the Sea Lion Island population, from 1995 to 2002.

AI.2 Elephant seal agonistic behaviour

In elephant seals, competition between males is related to mating: the main mating strategy is harem defence polygyny; males compete among each other to set up a dominance hierarchy, and males with highest ranks gain control of harems (Le Boeuf and Petrinovich, 1974a; McCann, 1981). Agonistic interactions between males are dyadic (i.e. no interactions involve more than two males) and asymmetric (i.e. males have different age, size, status, etc and they hold different numbers of females), and asymmetries depends on male physical features plus the local demography and sociology (Galimberti et al., 2003; Modig, 1996). These features define the agonistic skills of a male, which are globally referred to as its *resource holding potential* (RHP: Parker, 1974). Male elephant seals mainly compete using indirect interactions, which consist of stereotyped optical and acoustic displays. If agonistic conflict cannot be resolved by displays, a fight may happen. In spite of its low frequency, fighting is a notable aspect of elephant seal social behavior, both in the NES (Haley, 1994; Sandegren, 1976) and in the SES (Braschi, 2004; McCann, 1981).

At Sea Lion Island, RHP asymmetries between males mainly depend on physical characteristics, like body mass and age, and on behavioural traits, such as aggressiveness, experience, and previous fighting record (Braschi, 2004). The extent of these asymmetries influences both the actual behavioural sequence of the interaction, and its agonistic intensity. At Sea Lion Island, when the differences in RHP between the two contestants are clear, the contest is usually settled by a vocal and/or optical display and fights between males with different RHP are very rare. In this case, the contest is almost always won by the male with higher RHP, whose main components are body length and

aggressiveness (Braschi, 2004). Therefore, the agonistic behaviour shown by Sea Lion Island elephant seal males seems to follow the standard predictions of the theoretical model of the evolution of agonistic behaviour, although factors difficult to measure, such as personality, play an important role (unpublished data).

For example, the resource value and the reproductive payoffs should be an important aspect of the assessment process during elephant seal agonistic encounters, because the mating system is based on the direct defence of females. However, both the presence and the size of a harem in the area where the interaction takes place have no influence on the intensity of agonistic contests (Braschi, 2004).

AI.3 Elephant seal male vocalizations

Vocalizations have been studied mainly in the northern species (Le Boeuf and Peterson, 1969; Le Boeuf and Petrinovich, 1974a; Le Boeuf and Petrinovich, 1974b; McCann, 1981; Sandegren, 1976; Sanvito, 1997; Sanvito and Galimberti, 2000a; Sanvito and Galimberti, 2000b; Sanvito and Galimberti, 2003; Shipley et al., 1981; Shipley et al., 1986; Southall, 2002; Southall et al., 2003). Little information was available for the southern species (Le Boeuf and Petrinovich, 1974a) until recently (Sanvito, 1997; Sanvito and Galimberti, 2000a; Sanvito and Galimberti, 2000b; Sanvito and Galimberti, 2003).

Male elephant seals have a small vocal repertoire of four vocal classes: snort, agonistic vocalization (AV), submissive vocalization, and female-like vocalization, the latter having been observed just in the SES (Sanvito, 1997). AV, which is the subject of this study, is present in both species, and is the most frequent and conspicuous of the four. It is a low-frequency pulse train, with well defined macrostructure, high sound level, and

strong individuality (Sanvito and Galimberti, 2000a; Sanvito and Galimberti, 2000b). AV is produced at the beginning of agonistic contests, is present in most of them, and in many cases is the behavioural pattern that resolves the contest (Fabiani, 1996). Males usually emit the AV when interacting with other males, but also when approached by humans (Sanvito and Galimberti, 2000a). AV likely corresponds to *V2* vocalization of McCann (1981) and *VO2* vocalization of Sandegren (1976). I adopted an independent nomenclature because those authors presented no acoustic analysis. Some authors apparently discriminate between two kinds of AV on the basis of the number of syllables (*clap threat* and *burst threat* of NES; Shipley et al., 1986). These two kinds are, in fact, the two extremes of the observed variation in syllable rates, which is large and specific to each individuals. Therefore, this classification seems somehow arbitrary, and masks the effective variation in syllable structure, that permits us the identification of a rather large number of vocal types, whose presence and frequency change along the years (Chapter 4). Males can emit the AV while adopting different behavioural postures (Figure AI.4). I recognized three main postures: head up, on the flippers, and on the belly. In the *head up* posture, the male is lying down and just raises the head; in the *on the flippers* posture, the male sustains the fore part of body on the fore flippers; in the *on the belly* posture, the male rises the anterior part of the body on the posterior part, taking the fore flippers off the ground. The acoustic structure of sounds emitted in these different postures is very similar (Sanvito, 1997).

Based on a small data set from early in the SES breeding season, AV reportedly are similar between elephant seal species (Le Boeuf and Petrinovich, 1974a). Both

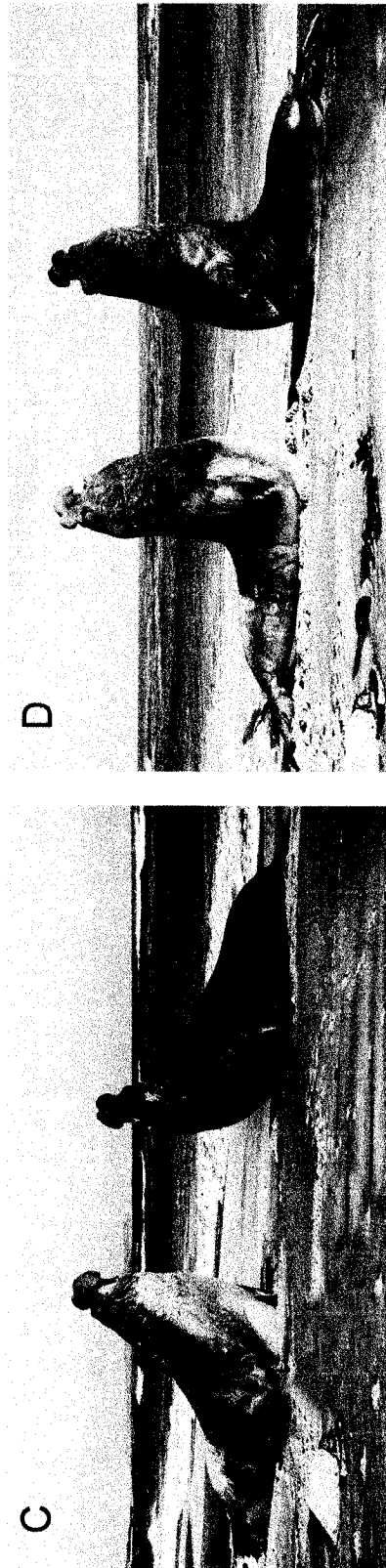
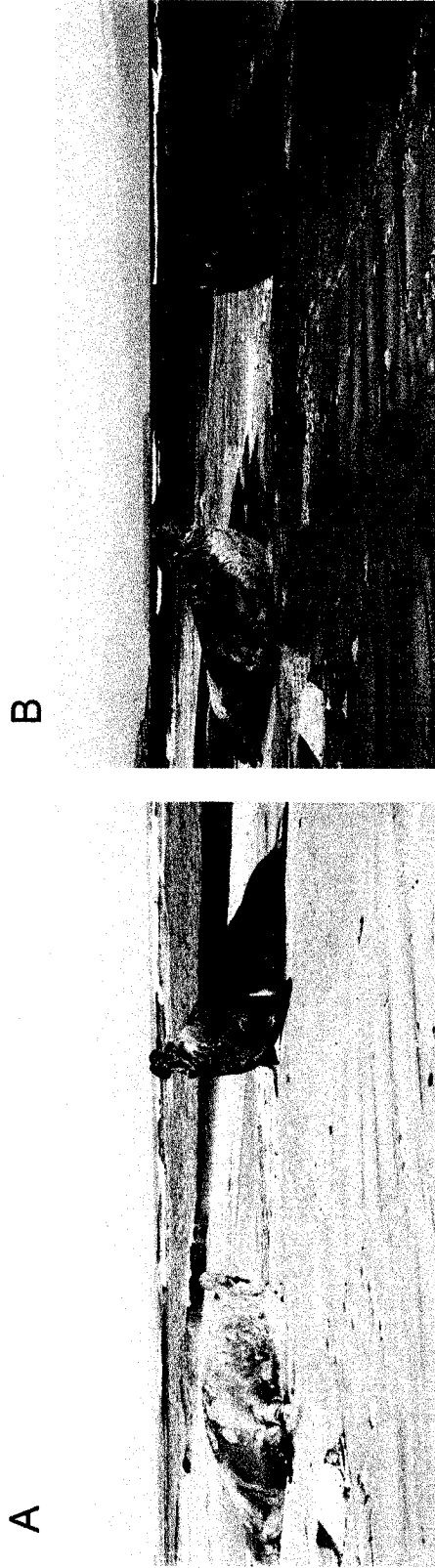

Figure A1.4 - Vocalizing postures used during agonistic interactions between adult male southern elephant seals during the breeding season (A-D). Note the varied postures used. Both males vocalizing in head up and on the flippers in A; both males vocalizing in head up posture in B; both males vocalizing on the flippers in C and both vocalizing on the belly in D.

species emit powerful, low-frequency pulse trains, but syllable structure appears rather different and calls are more powerful in SES (Sanvito and Galimberti, 2003). NES vocalizations have a simple structure because syllables are similar in duration, intensity, and frequency modulation; in contrast, SES vocalizations are more complex and syllables vary in structure. SES agonistic vocalizations are emitted during expiration only (*contra* Le Boeuf and Petrinovich, 1974 a), as in the NES. An ongoing comparative study (unpublished data) is revealing various differences, not only in the acoustic structure of the sounds (which are more pulsed in the NES) but also in behavioural patterns used to vocalize (much more pronounced head up posture in the NES) and in the effectiveness of vocalizations (much smaller proportion of contests settled by vocalization in the NES).

AV is sometimes emitted autonomously, without any other male in the proximity, and without any behavioural reaction from other males. For each male, autonomous vocalizations have the same acoustic structure of vocalizations emitted during agonistic contests (Sanvito and Galimberti, 2000a). Autonomous vocalization sequences can be very long, with the male repeating the vocalization rhythmically many times. In other species, vocalizations non-directed to a specific individual, and outside agonistic contests, can be used to advertise the breeding status of the emitter (*Cervus elaphus*: Clutton-Brock and Albon, 1979; *Dama dama*: McElligott and Hayden, 1999; *Odobenus rosmarus*: Stirling et al., 1987), but this doesn't seem to be the case in elephant seals. At Sea Lion Island, the time spent in the emission of autonomous vocalizations by harem holders is higher at the beginning of the season, when there are few females on land, the breeding status of males is not yet well defined, and the harem system is still fluid. Then it rapidly declines, reaching the minimum around the period when the maximum number of females

come into oestrus (Sanvito, 1997). Therefore, harem holders seems not to advertise at all their status by vocalization. Moreover, the harem holders are much less involved in the emission of autonomous vocalizations than other males, and most vocalizations (~75%) are emitted by solitary males and the frequency of autonomous vocalizations emitted declines with the number of females in proximity. The function of autonomous vocalizations remains obscure. A suggestive hypothesis, yet to be tested, is that the autonomous vocalization is simply a way to recover a good competence in vocalizing. Elephant seals are completely silent while at sea (Fletcher et al., 1996), and, therefore, after haulout at the beginning of the breeding season, they may need some practice to be able to produce a proper vocalization. The practice hypothesis is supported by the fact that peripheral males spend almost the same percentage of time in autonomous vocalizations throughout the whole breeding season.

The “snort” (Figure A1.5) is a peculiar sound emission produced by the air passing through the relaxed proboscis and causing it to vibrate (Bartholomew and Collias, 1962; Shipley et al., 1981). It was called *VI* in the SES (McCann, 1981) and *VOI* in the NES: “The sound resembles the snort of a horse, which is produced in a similar way.” (Sandegren, 1976, page 140). It is considered a low intensity display of aggressiveness by these authors, as it appears sometimes before the beginning of agonistic interactions. Compared with AV it is of lower intensity and higher dominant frequency (~600 Hz; Bartholomew and Collias, 1962). In the study population, the snort is associated with the alert phase preliminary to agonistic interactions, in which the male directs his attention towards the opponent and inflates his proboscis (Fabiani, 1996). Even though some authors consider the snort a true vocalization (Bartholomew and Collias, 1962), I do not

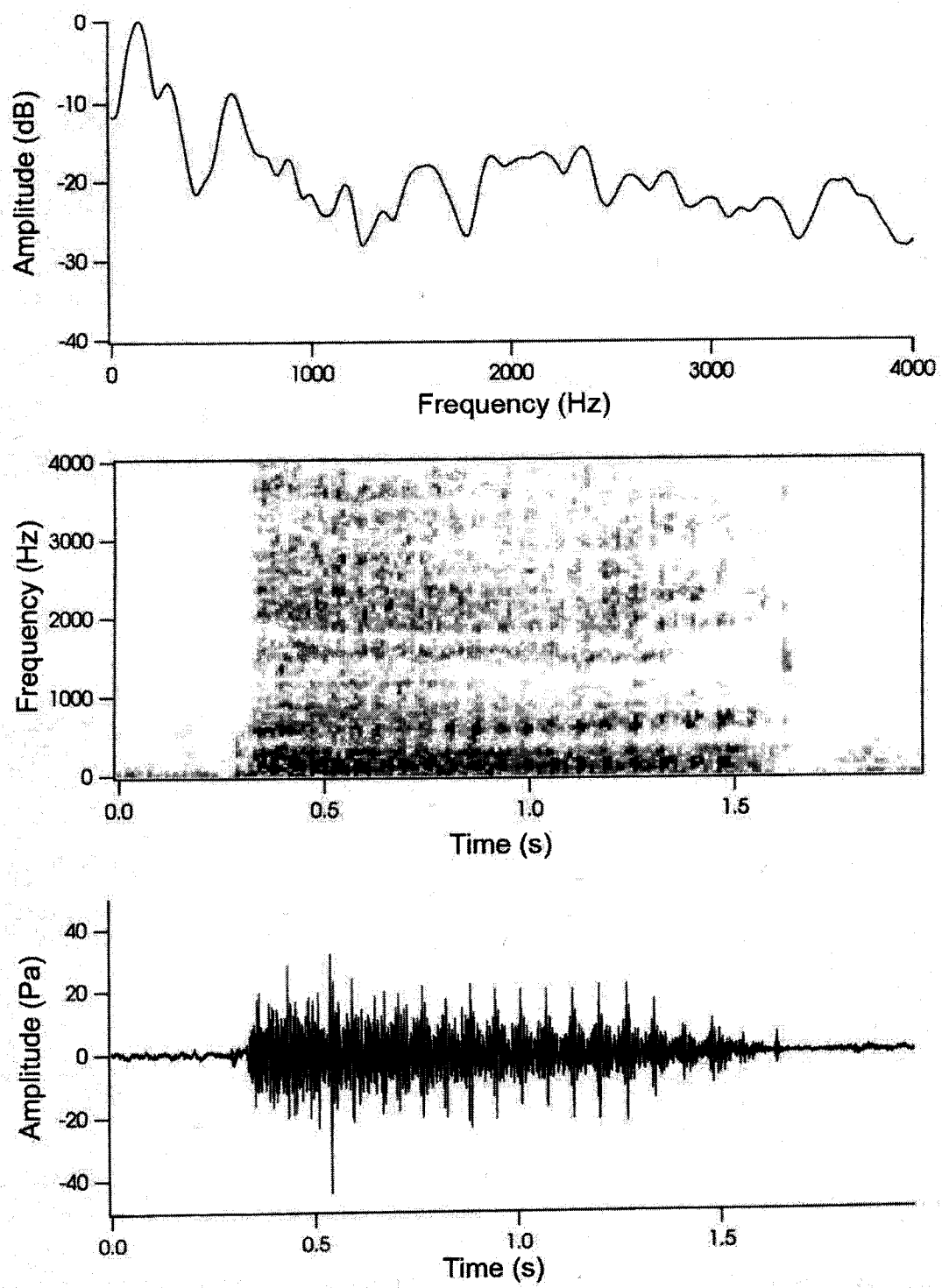

Figure A1.5 - Typical snort vocalization of adult male southern elephant seal during the breeding season. Average power spectrum (top); spectrogram (middle) and waveform (bottom).

find this appropriate, because its emission does not involve the vocal folds. Moreover, the snort is difficult for a human to hear more than a few metres away, and seems to be a by-product of inflation, which is a true, optical signal of male arousal.

The submissive vocalization (Figure AI.6) is present in both species, and was named *V3* in the SES (McCann, 1981) and *VO3* in the NES (Sandegren, 1976). This vocalization is often emitted during the final phase of the agonistic contest, when the defeated male retreats. It is emitted only in this context, although not all defeated male actually emit this vocalization. The submissive posture seems a clear case of the “antithesis principle” (Darwin, 1872), that consists in the adoption of a set of behavioural patterns that is opposite to the pattern showed during aggression. When adopting a submissive posture, the male retreats, opens the mouth, moves the head backward, and emits a vocalization that has an acoustic structure that contrasts with the structure of the AV (Sanvito, 1997). In particular, the submissive vocalization is not a pulse train but on the contrary has a rather harmonic structure. The mean first formant frequency and dominant frequency, which are the same in this case, of submissive vocalizations is 398 Hz, much higher than in the AV. Moreover, the submissive vocalization shows a clear frequency modulation, and has a harmonic component with fundamental frequency around 100-150 Hz. In all, it resembles sounds emitted by females when calling their pups. Submissive communication is rather common, and quite similar across many pinniped species (Miller, 1991).

The “female-like” vocalization is a peculiar call that has been noted only in my study (Sanvito, 1997). It is rare and its function is obscure. It is emitted with open mouth and retracted proboscis and has a much higher dominant frequency than the agonistic

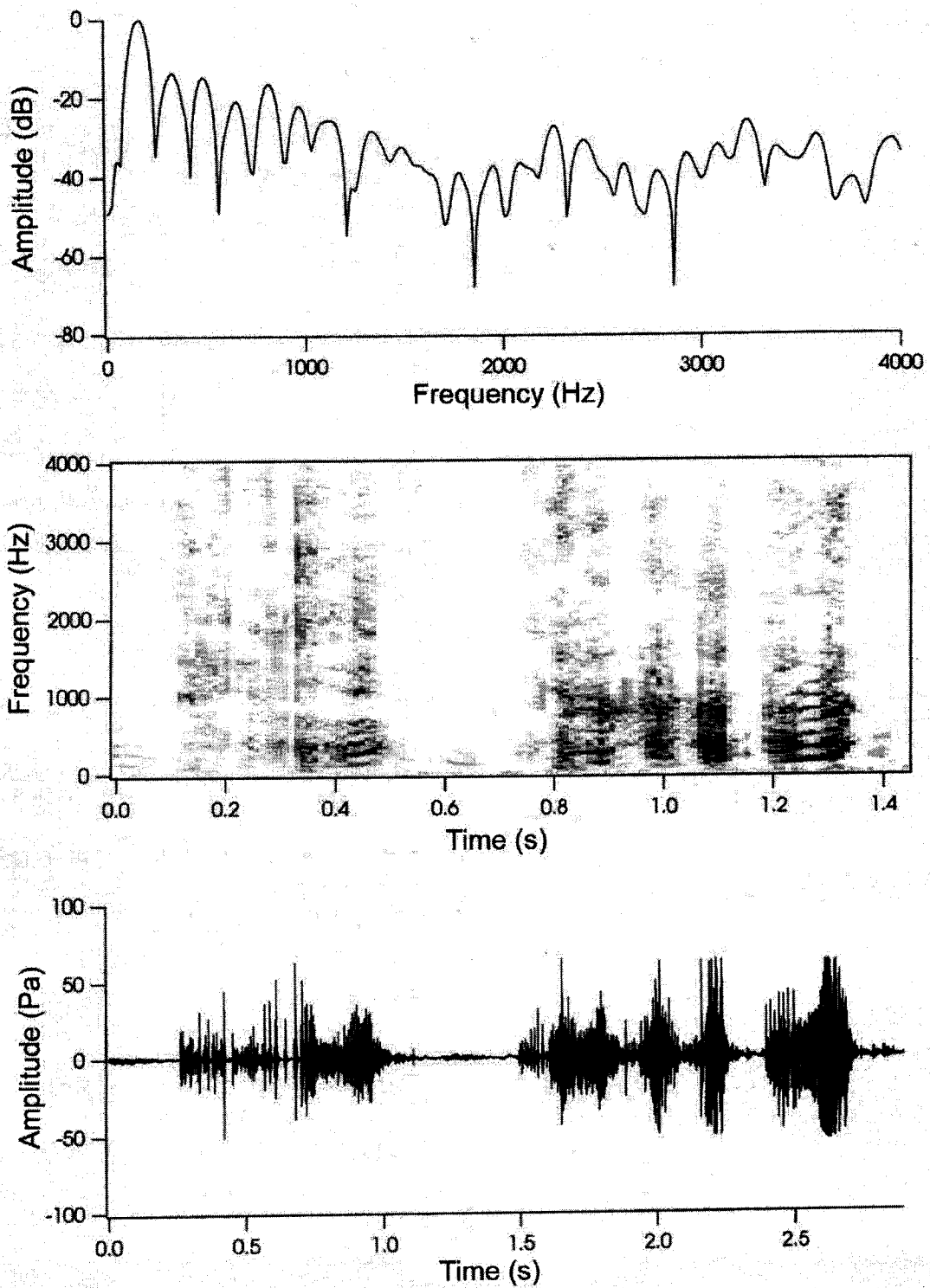

Figure AI.6 - Typical submissive vocalization of adult male southern elephant seal during the breeding season. Average power spectrum (top); spectrogram (middle) and waveform (bottom).

vocalization. Its acoustical structure and emission posture are very similar to vocalizations of females used to call the pups (unpublished data and personal observation). McCann (1981) described a male vocalization (*V0*) of low intensity, produced by inhalation through the open mouth sometimes emitted during male-female interactions. On the contrary, the female-like vocalization I recorded at SLI, is uttered with an exhalation. The female-like vocalization is rare and it seems to be the result of stressful situations. In fact, it is emitted most frequently by harem holders after a series of unsuccessful mating attempts, without presence of or interaction with other males.

In conclusion, the agonistic vocalization is the most important component of male acoustic communication, both for its frequency and its role in elephant seal social behaviour. Most statements about its specific function found in the literature are based on anecdotal evidence, and there is a significant lack of quantification of the use of this vocalization. Moreover, even the basic information about the frequency and context of use of agonistic vocalization are scanty. Although there are quite a few descriptions of these vocalizations in the literature, mostly on NES (e.g., Bartholomew and Collias 1962; Sandegren 1976; Le Boeuf and Petrinovich 1974), I was not able to find any quantification to make a comparison with the SLI population. From my (unpublished) data about the Valdès Peninsula (Argentina) SES population and the San Benitos (Baja California, Mexico) NES population it appears clear that the use of vocalizations in different populations depends on the local social structure, and that there are much greater differences in vocal behaviour, and agonistic behaviour in general, between the two species than usually stated. For example, the effectiveness of vocal threats in settling contests is much lower in the NES of San Benitos than in both SES populations.

AI.4 LITERATURE CITED

- Bartholomew G.A., Collias N.E., 1962. The role of vocalization in the social behaviour of the Northern Elephant Seal. *Animal Behaviour*. **10**:7-14.
- Bradbury J.W., Vehrencamp S.L., 1998. *Principles of Animal Communication*. Massachusettes: Publishers. Sunderland.
- Braschi C., 2004. Comportamento agonistico negli elefanti marini del sud (PhD). Roma, Italy: University of Roma "La Sapienza".
- Carrick R., Csordas S.E., Ingham S.E., Keith K., 1962. Studies on the southern elephant seal, *Mirounga leonina* (L.). III. The annual cycle in relation to age and sex. *C.S.I.R.O. Wildlife Research*. **7**:119-160.
- Clinton W.L., 1994. Sexual selection and growth in male Northern Elephant Seals. In: *Elephant seals. Population ecology, behavior, and physiology* (Le Boeuf B.J., Laws R.M. eds). Berkeley (CA): University of California Press; 154-168.
- Clinton W.L., Le Boeuf B.J., 1993. Sexual selection's effects on male life history and the pattern of male mortality. *Ecology*. **74**:1884-1892.
- Clutton-Brock T.H., 1989. Mammalian mating systems. *Proceedings of the Royal Society Biological Sciences Series B*. **236**:339-372.
- Clutton-Brock T.H., Albon S.D., 1979. The roaring of red deer and the evolution of honest advertisement. *Behaviour*. **69**:145-170.
- Darwin C., 1872. *The expression of the emotions in man and animals*. London: Murray.
- Fabiani A., 1996. Aspetti strutturali e funzionali del comportamento agonistico maschile nell' elefante marino del sud (*Mirounga leonina*) [Structural and functional aspects

- of male agonistic behaviour in southern elephant seals (*Mirounga leonina*)]
(Degree Thesis). Roma, Italy: Università degli Studi di Roma "La Sapienza".
- Fletcher S., Le Boeuf B.J., Costa D.P., Tyack P.L., Blackwell S.B., 1996. Onboard acoustic recording from diving northern elephant seals. *Journal of the Acoustical Society of America*. **100**:2531-2539.
- Galimberti F., Boitani L., 1999. Demography and breeding biology of a small, localized population of southern elephant seals (*Mirounga leonina*). *Marine Mammal Science*. **15**:159-178.
- Galimberti F., Boitani L., Marzetti I., 2000. The frequency and costs of harassment in southern elephant seals. *Ethology Ecology & Evolution*. **12**:345-365.
- Galimberti F., Fabiani A., Boitani L., 2003. Socio-spatial levels in linearity analysis of dominance hierarchies: a case study on elephant seals. *Journal of Ethology*. **21**:131-136.
- Galimberti F., Sanvito S., 2001. Modelling females haul out in southern elephant seals (*Mirounga leonina*). *Aquatic Mammals*. **27**:92-104.
- Galimberti F., Sanvito S., Braschi C., Boitani L., submitted. The cost of success: reproductive effort in male southern elephant seals. *Behavioral Ecology and Sociobiology*.
- Haley M.P., 1994. Resource-holding power asymmetries, the prior residence effect, and reproductive payoffs in male northern elephant seal fights. *Behavioral Ecology and Sociobiology*. **34**:427-434.
- Le Boeuf B.J., 1974. Male-male competition and reproductive success in elephant seals. *American Zoologist*. **14**:163-176.

- Le Boeuf B.J., Laws R.H., 1994. Elephant seals: an introduction to the genus. In:
Elephant seals. Population ecology, behavior and physiology (Le Boeuf B.J.,
Laws R.H. eds). Berkeley, CA: University of California Press; 1-26.
- Le Boeuf B.J., Peterson R.S., 1969. Dialects in elephant seals. *Science*. **166**:1654-1656.
- Le Boeuf B.J., Petrinovich L.F., 1974a. Elephant seals: interspecific comparisons of vocal
and reproductive behavior. *Mammalia*. **38**:16-32.
- Le Boeuf B.J., Petrinovich L.F., 1974b. Dialects of northern elephant seals, *Mirounga*
angustirostris: origin and reliability. *Animal Behaviour*. **22**:656-663.
- McCann T.S., 1981. Aggression and sexual activity of male Southern elephant seals,
Mirounga leonina. *Journal of Zoology London*. **195**:295-310.
- McElligott A.G., Hayden T.J., 1999. Context-related vocalization rates of fallow bucks,
Dama dama. *Animal Behaviour*. **58**:1095-1104.
- Modig A.O., 1996. Effects of body size and harem size on male reproductive behaviour in
the southern elephant seal. *Animal Behaviour*. **51**:1295-1306.
- Parker G.A., 1974. Assessment strategy and the evolution of fighting behaviour. *Journal*
of theoretical Biology. **47**:223-243.
- Riedman M., 1990. *The pinnipeds: seals, sea lions and walruses*. Berkeley: Un.
California Press.
- Sandegren F.E., 1976. Agonistic behavior in the male Northern Elephant seal. *Behaviour*.
57:136-158.
- Sanvito S., 1997. Struttura, ontogenesi e funzione dei vocalizzi maschili nell' elefante
marino del sud (*Mirounga leonina*) [Structure, ontogeny and function of male

- vocalizations in southern elephant seals (*Mirounga leonina*)] (Degree Thesis).
Milano, Italy: Università degli Studi di Milano.
- Sanvito S., Galimberti F., 2000a. Bioacoustics of southern elephant seals. I. Acoustic structure of male aggressive vocalizations. *Bioacoustics*. **11**:259-285.
- Sanvito S., Galimberti F., 2000b. Bioacoustics of southern elephant seals. II. Individual and geographical variation in male aggressive vocalizations. *Bioacoustics*. **11**:287-307.
- Sanvito S., Galimberti F., 2003. Source level of male vocalizations in the genus *Mirounga*: repeatability and correlates. *Bioacoustics*. **14**:45-57.
- Shipley C., Hines M., Buchwald J.S., 1981. Individual differences in threat calls of northern elephant seal bulls. *Animal Behaviour*. **29**:12-19.
- Shipley C., Hines M., Buchwald J.S., 1986. Vocalizations of northern elephant seal bulls: development of adult call characteristics during puberty. *Journal of Mammalogy*. **67**:526-536.
- Southall B.L., 2002. Northern elephant seal field bioacoustics and aerial auditory masked hearing thresholds in three pinnipeds (PhD). Santa Cruz, California: University of California.
- Southall B.L., Schusterman R.J., Kastak D., 2003. Acoustic communication ranges for northern elephant seals (*Mirounga angustirostris*). *Aquatic Mammals*. **29**:202-213.
- Stirling I., Calvert W., Spencer C., 1987. Evidence of stereotyped underwater vocalizations of male Atlantic walruses (*Odobenus rosmarus rosmarus*). *Canadian Journal of Zoology*. **65**:2311-2321.